



Instructions for the following series products:

DELTA™ Full Body Harnesses

(See back pages for specific model numbers.)

**USER INSTRUCTION MANUAL
DELTA™ FULL BODY HARNESS**

This manual is intended to meet the Manufacturer's Instructions as required by ANSIZ359.1 and CSA 259.10 and should be used as part of an employee training program as required by OSHA



Figure 1



Figure 2



Figure 3



Figure 4



WARNING: This product is part of a personal fall arrest, restraint, work positioning, personnel riding, climbing, or rescue system. The user must follow the manufacturer's instructions for each component of the system. These instructions must be provided to the user of this equipment. The user must read and understand these instructions before using this equipment. Manufacturer's instructions must be followed for proper use and maintenance of this equipment. Alterations or misuse of this product or failure to follow instructions may result in serious injury or death.

IMPORTANT: If you have questions on the use, care, or suitability of this equipment for your application, contact Capital Safety.

IMPORTANT: Before using this equipment, record the product identification information from the ID label in the inspection and maintenance log of this manual.

DESCRIPTIONS

Delta Vest™ Full Body Harness: See Figure 1.

Vest Style Full Body Harness: See Figure 2.

Cross-Over Style Full Body Harness: See Figure 3.

Step-In Style Full Body Harness: See Figure 4.

OPTIONS:

DBI-SALA Full Body Harnesses are available with options and accessories. Following is a partial list of commonly used options and accessories (some options may not be available on all harnesses):

- Shoulder D-rings
- Side D-rings
- Hip pad with side D-rings
- Quick Connect buckles
- Tongue buckle body belt
- Loops on harness for body belt
- Kevlar® webbing
- High visibility webbing
- Non-sparking/Non conductive PVC coated hardware
- Shoulder pads
- Tool belt support straps
- Seat sling
- Lanyard attached directly to D-ring or attachment element
- Snap fastener on shoulder strap for retaining lanyard
- Delta Vest™
- Tool holders

1.0 APPLICATIONS

1.1 PURPOSE: DBI-SALA full body harnesses are to be used as components in personal fall arrest, restraint, work positioning, or rescue systems. See Figures 1, 2, 3, and 4 for harness styles.

Harnesses included in this manual are full body harnesses and meet ANSI Z359.1, OSHA, and CSA Z259.10 requirements. See Figure 5 for application illustrations.

- Full body harnesses with Kevlar web should be used when working with tools, materials, or environments of high temperature (foundries, chemical manufacturing, steel fabrication, emergency rescue services, fire services, welders, oil industry, nuclear industry, explosives).
- Harnesses with PVC coated hardware should be used when working in explosive or electrically conductive environments, or where surfaces must be protected from the hardware.
- Harnesses with high visibility webbing should be used when increased visibility of the user is required.

A. PERSONAL FALL ARREST: The full body harness is used as a component of a personal fall arrest system. Personal fall arrest systems typically include a full body harness and a connecting subsystem (energy absorbing lanyard). Maximum arresting force must not exceed 1,800 lbs (8 kN). For fall protection applications connect the fall arrest subsystem (example: lanyard, SRL, energy absorber, etc.) to the D-ring or attachment element on your back, between your shoulder blades.

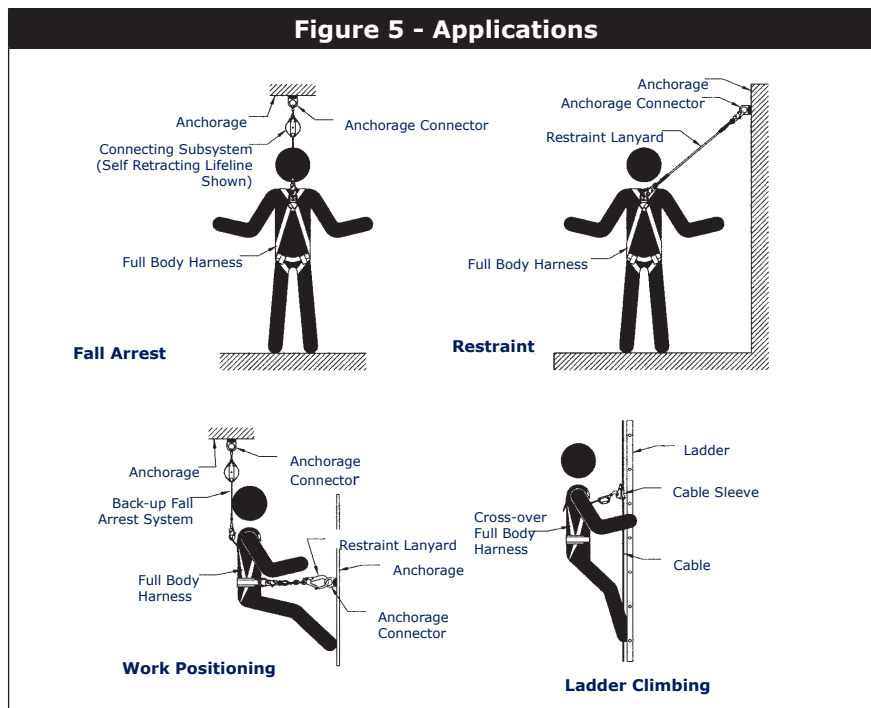

- B. WORK POSITIONING:** The full body harness is used as a component of a work positioning system to support the user at a work position. Work positioning systems typically include a full body harness, positioning lanyard, and a back-up personal fall arrest system. For work positioning applications, connect the work positioning subsystem (example: lanyard, Y-lanyard, etc.) to the lower (hip level) side or belt mounted work positioning attachment anchorage elements (D-rings). Never use these connection points for fall arrest.
- C. LADDER CLIMBING:** The full body harness is used as a component of a climbing system to prevent the user from falling when climbing a ladder or other climbing structure. Climbing systems typically include a full body harness, vertical cable or rail attached to the structure, and climbing sleeve. For ladder climbing applications, harnesses equipped with a frontal D-ring in the sternal location may be used for fall arrest on fixed ladder climbing systems. These are defined in Z259.2.1 in Canada and ANSI A14.3 in the United States.
- D. RESCUE:** The full body harness is used as a component of a rescue system. Rescue systems are configured depending on the type of rescue. For limited access (confined space) applications, harnesses equipped with D-rings on the shoulders may be used for entry and egress into confined spaces where worker profile is an issue.
- E. CONTROLLED DESCENT:** For controlled descent applications, harnesses equipped with a single sternal level D-ring, one or two frontal mounted D-rings, or a pair of connectors originating below the waist (such as a seat sling) may be used for connection to a descender or evacuation system (reference in Z259.10 in Canada).
- F. RESTRAINT:** The full body harness is used as a component of a restraint system to prevent the user from reaching a fall hazard. Restraint systems typically include a full body harness and a lanyard or restraint line.

1.2 LIMITATIONS: Consider the following application limitations before using this equipment:

- **CAPACITY:** These full body harnesses are designed for use by persons with a combined weight (clothing, tools, etc.) for ANSI Z359.1--310 lbs (141 kg), CSA Z259.10--352 lbs (160 kg). Make sure all of the components in your system are rated to a capacity appropriate to your application
- **FREE FALL:** Personal fall arrest systems used with this equipment must be rigged to limit the free fall to 6 feet (1.8 M) (ANSI Z359.1). Restraint systems must be rigged so that no vertical free fall is possible. Work positioning systems must be rigged so that free fall is limited to 2 feet (.6 m) or less. Personnel riding systems must be rigged so that no vertical free fall is possible. Climbing systems must be rigged so that free fall is limited to 18 in. (.46 m) or less. Rescue systems must be rigged so that no vertical free fall is possible. See subsystem manufacturer's instructions for more information.

Figure 6 - Fall Clearance

Figure 7 - Swing Falls

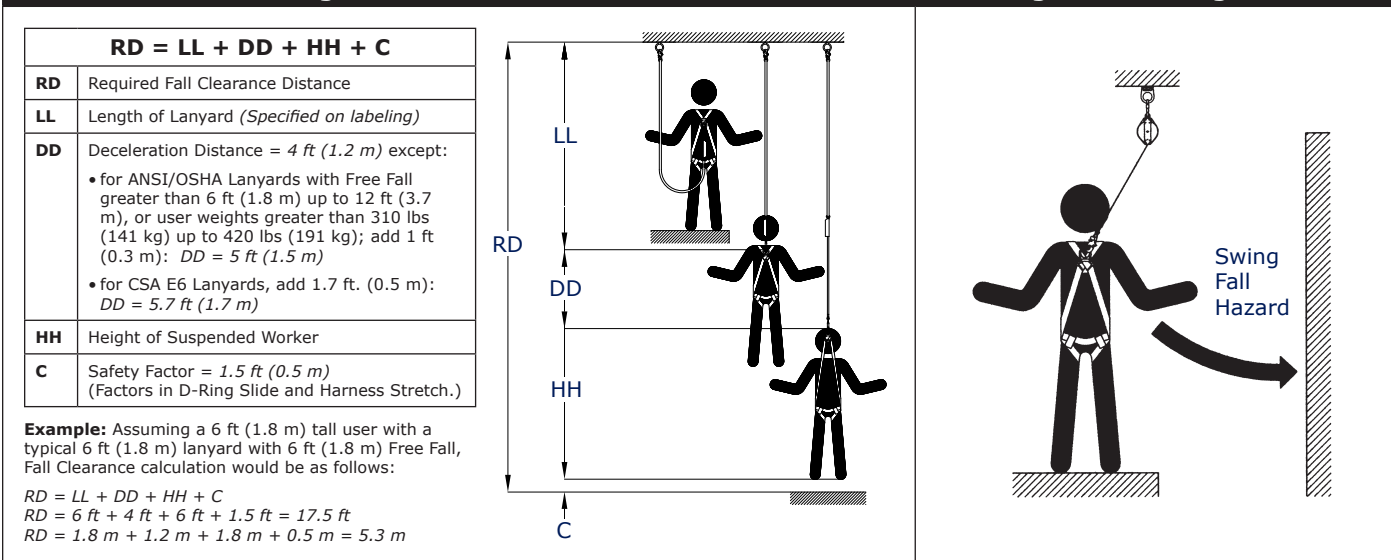

- FALL CLEARANCE:** See Figure 6. There must be sufficient clearance below the user to arrest a fall before the user strikes the ground or other obstruction. The clearance required is dependent on the following factors:

 - Elevation of Anchorage
 - Free fall distance
 - Connecting subsystem length
 - Worker height
 - Deceleration distance
 - Movement of harness attachment element

See subsystem manufacturer’s instructions for more information
- SWING FALLS:** See Figure 7. Swing falls occur when the anchorage point is not directly above the point where a fall occurs. The force of striking an object in a swing fall may cause serious injury or death. Minimize swing falls by working as close to the anchorage point as possible. Do not permit a swing fall if injury could occur. Swing falls will significantly increase the clearance required when a self- retracting lifeline or other variable length connecting subsystem is used.
- EXTENDED SUSPENSION:** A full body harness is not intended for use in extended suspension applications. If the user is going to be suspended for an extended length of time it is recommended that some form of seat support be used. DBI-SALA recommends a seat board, suspension workseat, seat sling, or a boatswain chair. Contact DBI-SALA for more information on these items.
- ENVIRONMENTAL HAZARDS:** Use of this equipment in areas with environmental hazards may require additional precautions to prevent injury to the user or damage to the equipment. Hazards may include, but are not limited to; heat, chemicals, corrosive environments, high voltage power lines, gases, moving machinery, and sharp edges.
- HARNESSES FOR HIGH TEMPERATURE ENVIRONMENTS:** Harnesses with Kevlar webbing are designed for use in high temperature environments, with limitations: Kevlar webbing begins to char at 800° to 900° Fahrenheit. Kevlar webbing can withstand limited contact exposure to temperatures up to 1,000° F. Polyester webbing loses strength at 300° to 400° F. PVC coating on hardware has a melting point of approximately 350° F.

IMPORTANT: When working with tools, materials, or in high temperature environments, ensure that associated fall protection equipment can withstand high temperatures, or provide protection for those items.

IMPORTANT: Although PVC coated, cadmium, or zinc plated hardware exhibit excellent corrosion resistance in chemical, acidic, alkaline, and atmospheric conditions, frequent inspections may be required. Consult with Capital Safety if you question the use of this equipment in hazardous environments.
- TRAINING:** This equipment must be installed and used by persons trained in its correct application and use. See section 4.0.

1.3 APPLICABLE STANDARDS: Refer to national standards, including ANSI Z359 (.0, .1, .2, .3, and .4) family of standards on fall protection, ANSI A10.32, CSA Z259.10, and applicable local, state and federal (OSHA) requirements governing occupational safety for more information about work positioning systems.

IMPORTANT: Harnesses with Kevlar webbing do not meet ANSI Z359.1. Kevlar does not have equivalent abrasion resistance of polyamides. Kevlar harnesses meet all other requirements of this standard.

2.0 SYSTEM REQUIREMENTS

2.1 COMPATIBILITY OF COMPONENTS: Capital Safety equipment is designed for use with Capital Safety approved components and subsystems only. Substitutions or replacements made with non-approved components or subsystems may jeopardize compatibility of equipment and may effect the safety and reliability of the complete system.

2.2 COMPATIBILITY OF CONNECTORS: Connectors are considered to be compatible with connecting elements when they have been designed to work together in such a way that their sizes and shapes do not cause their gate mechanisms to inadvertently open regardless of how they become oriented. Contact Capital Safety if you have any questions about compatibility.

Connectors (hooks, carabiners, and D-rings) must be capable of supporting at least 5,000 lbs. (22.2 kN). Connectors must be compatible with the anchorage or other system components. Do not use equipment that is not compatible. Non-compatible connectors may unintentionally disengage. See Figure 8. Connectors must be compatible in size, shape, and strength. Self-locking snap hooks and carabiners are required by ANSI Z359.1 and OSHA.

2.3 MAKING CONNECTIONS: Use only self-locking snap hooks and carabiners with this equipment. Use only connectors that are suitable to each application. Ensure all connections are compatible in size, shape and strength. Do not use equipment that is not compatible. Ensure all connectors are fully closed and locked.

Capital Safety connectors (snap hooks and carabiners) are designed to be used only as specified in each product's user's instructions. See Figure 9 for inappropriate connections. Capital Safety snap hooks and carabiners should not be connected:

To a D-ring to which another connector is attached.

- A. To a D-ring to which another connector is attached.
- B. In a manner that would result in a load on the gate.

NOTE: Large throat snap hooks should not be connected to standard size D-rings or similar objects which will result in a load on the gate if the hook or D-ring twists or rotates, unless the snap hook complies with ANSI Z359.1 or ANSI Z359.12 and is equipped with a 3,600 lb (16 kN) gate. Check the marking on your snap hook to verify that it is appropriate for your application.

- C. In a false engagement, where features that protrude from the snap hook or carabiner catch on the anchor, and without visual confirmation seems to be fully engaged to the anchor point.
- D. To each other.
- E. Directly to webbing or rope lanyard or tie-back (unless the manufacturer's instructions for both the lanyard and connector specifically allows such a connection).
- F. To any object which is shaped or dimensioned such that the snap hook or carabiner will not close and lock, or that roll-out could occur.
- G. In a manner that does not allow the connector to align properly while under load.

2.4 CONNECTING SUBSYSTEMS: Connecting subsystems (self-retracting lifeline, lanyard, rope grab and lifeline, cable sleeve) must be suitable for your application. See Section 1.1. See subsystem manufacturer's instructions for more information. Some harness models have web loop connection points. Do not use snap hooks to connect to web loops. Use a self-locking carabiner to connect to a web loop. Ensure the carabiner cannot cross-gate load (load against the gate rather than along the backbone of the carabiner). Some lanyards are designed to choke onto a web loop to provide a compatible connection (see Figure 10). Lanyards may be sewn directly to the web loop forming a permanent connection. Do not make multiple connections onto one web loop, unless choking two lanyards onto a properly sized web loop.

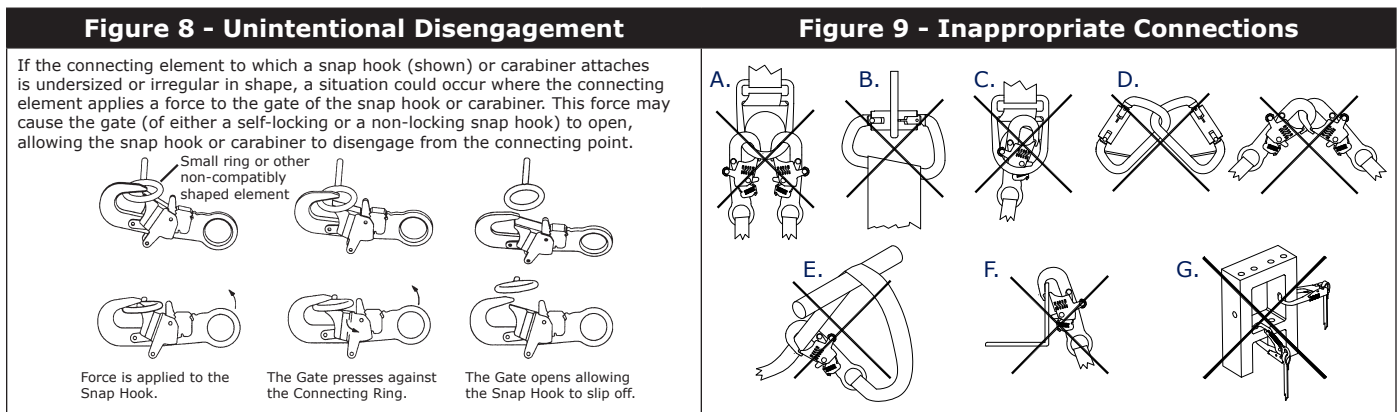
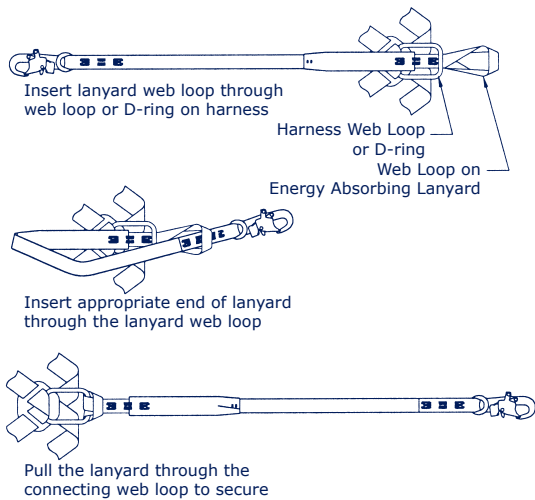
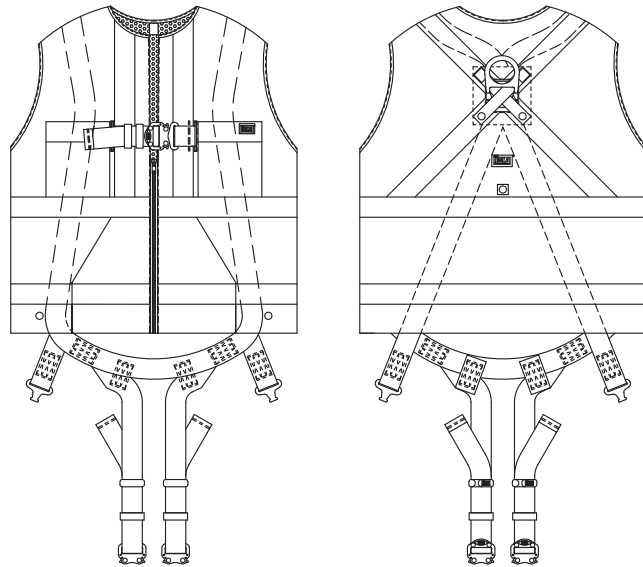

Figure 10 - Web Loop Connections**Figure 11 - Front and Back of Delta Vest™ Harness**

2.5 ANCHORAGE STRENGTH: The anchorage strength required is dependent on the application type. The following are the requirements of ANSI 359.1 for these application types:

- A. FALL ARREST:** Anchorages selected for fall arrest systems shall have a strength capable of sustaining static loads applied in the directions permitted by the system of at least:
 1. 5,000 lbs. (22.2 kN) for non-certified anchorages, or
 2. Two times the maximum arresting force for certified anchorages. When more than one fall arrest system is attached to an anchorage, the strengths set forth in (1) and (2) above shall be multiplied by the number of systems attached to the anchorage.
- B. RESTRAINT:** Anchorages selected for restraint and travel restraint systems shall have a strength capable of sustaining static loads applied in the directions permitted by the system of at least:
 1. 1,000 lbs. (4.5 kN) for non-certified anchorages, or
 2. Two times the foreseeable force for certified anchorages. When more than one restraint and travel restraint system is attached to an anchorage, the strengths set forth in (1) and (2) above shall be multiplied by the number of systems attached to the anchorage.
- C. WORKING POSITIONING:** Anchorages selected for work positioning systems shall have a strength capable of sustaining static loads applied in the directions permitted by the system of at least:
 1. 3,000 lbs. (13.3 kN) for non-certified anchorages, or
 2. Two times the foreseeable force for certified anchorages. When more than one work positioning system is attached to an anchorage, the strengths set forth in (1) and (2) above shall be multiplied by the number of systems attached to the anchorage.
- D. RESCUE:** Anchorages selected for rescue systems shall have a strength capable of sustaining static loads applied in the directions permitted by the system of at least:
 1. 3,000 lbs. (13.3 kN) for non-certified anchorages, or
 2. Five times the foreseeable force for certified anchorages. When more than one rescue system is attached to an anchorage, the strengths set forth in (1) and (2) above shall be multiplied by the number of systems attached to the anchorage.
- E. CLIMBING:** The structure to which a climbing system is attached must sustain the loads required by that particular system. See instructions for climbing system for requirements.

3.0 DONNING AND USE

WARNING: Do not alter or intentionally misuse this equipment. Consult DBI-SALA when using this equipment in combination with components or subsystems other than those described in this manual. Some subsystem and component combinations may interfere with the operation of this equipment. Use caution when using this equipment around moving machinery, electrical and chemical hazards, and sharp edges.

WARNING: Consult your doctor if there is reason to doubt your fitness to safely absorb the shock from a fall arrest. Age and fitness seriously affect a worker's ability to withstand falls. Pregnant women or minors must not use any DBI-SALA full body harness.

3.1 BEFORE EACH USE of this equipment inspect it according to section 5.0 of this manual.

3.2 PLAN your system before use. Consider all factors that will affect your safety during use of this equipment. The following list gives important points to consider when planning your system:

- **ANCHORAGE:** Select an anchorage that meets the requirements specified in sections 1.2 and 2.5.
- **SHARP EDGES:** Avoid working where system components may be in contact with, or abrade against, unprotected sharp edges.
- **AFTER A FALL:** Components which have been subjected to the forces of arresting a fall must be removed from service and destroyed.
- **RESCUE:** The employer must have a rescue plan when using this equipment. The employer must have the ability to perform a rescue quickly and safely.

3.3 DONNING AND FITTING THE HARNESS:

Delta Vest™ Harness:

See Figure 11 for front and back views of the Delta Vest™ harness. Don the Delta Vest™ full body harness by following these steps. (See Figures 12 and 13.)

- Step 1.** Lift harness by the back D-ring and untangle straps. Allow leg straps to hang free.
- Step 2.** Don the Vest Harness as you would a jacket. Do not zip the vest at this time.
- Step 3.** Connect chest strap by passing male buckle through female buckle. Pass excess webbing through loop keepers.
- Step 4.** Reach between legs and grasp the leg strap on your left side. Bring the strap up between your legs and connect to buckle attached to yellow strap (orange on high visibility models, black on flame resistant models) as shown in Figures 12 and 13. Connect right leg strap.
- Step 5.** Reach inside the vest and adjust shoulder straps to a snug fit. Left and right shoulder straps should be adjusted to the same length. Readjust leg straps, chest strap, and shoulder straps as necessary to a snug fit.
- Step 6.** Zip the vest.

Figure 12 - Donning the Delta Vest™ Harness

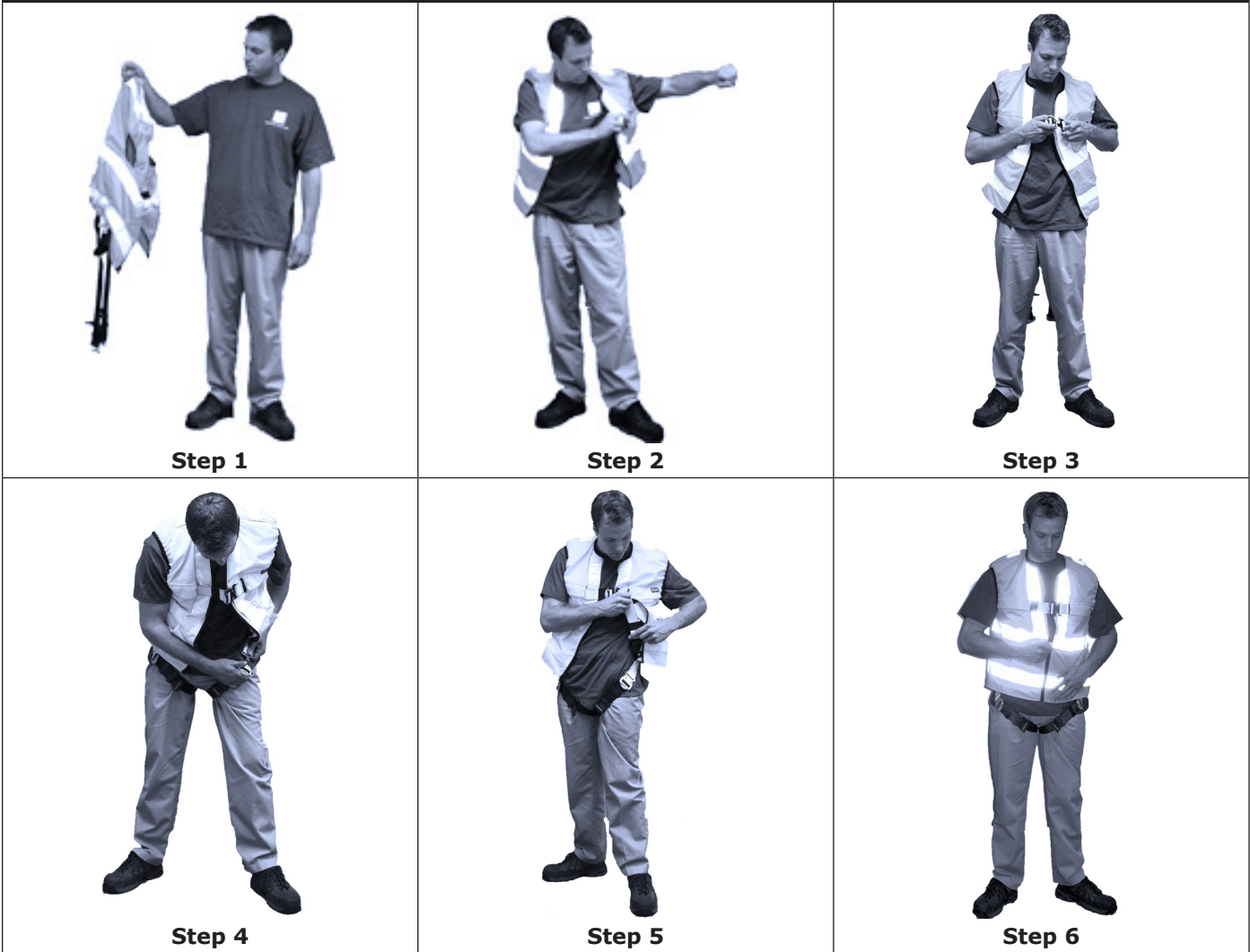

Step 1

Step 2

Step 3

Step 4

Step 5

Step 6

Figure 13A - Delta Vest™ Harness Buckle Connections

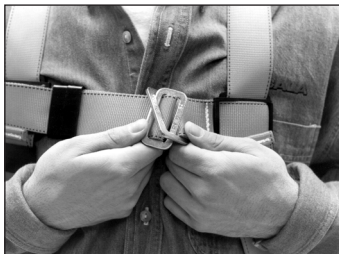

Chest Strap: Pass male buckle through female buckle and pull free end of webbing to tighten.



Tongue Buckle: Pass webbing through buckle and insert tongue through grommet.



Pass Buckle: Pass male buckle through female buckle and pull free end of webbing to tighten.



Quick Connect Buckle: Insert the tab of the buckle into the receptor of the quick connect buckle until a click is heard.

Figure 13B - Revolver™ Vertical Torso Adjuster

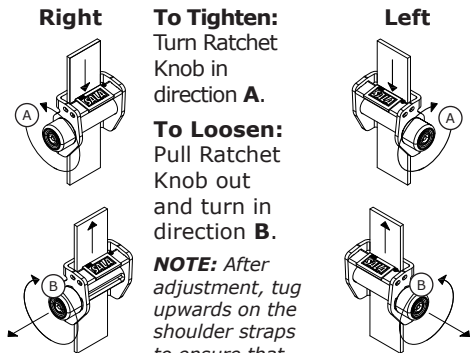

Right To Tighten: Turn Ratchet Knob in direction **A**.

To Loosen: Pull Ratchet Knob out and turn in direction **B**.

NOTE: After adjustment, tug upwards on the shoulder straps to ensure that each adjuster is locked in place.

Vest Style Harness:

If your harness incorporates loops for a removable waist belt, the belt should be installed through the four loops in the harness as shown in Figure 14. The hip pad, if used, is secured to the belt by passing the belt through the hip pad loops. Don the vest style full body harness by following these steps (see Figures 14-16B):

NOTE: Vest Style harnesses contain different harness buckle connections. See Figure 16A for the style that applies to your harness.

- Step 1.** Locate back D-ring held in position by the D-ring pad; lift up harness and hold by this D-ring. Ensure the straps are not twisted.
- Step 2.** Grasp the shoulder straps and slip harness onto one arm. D-ring will be located on your back side. Ensure straps are not tangled and hang freely. Slip free arm into harness and position shoulder straps on top of shoulder. Chest strap buckle will be positioned on front side when worn properly. Pass excess strap through the loop keepers.
- Step 3.** Reach between your legs and grasp the leg strap on your left side. Bring the strap up between your legs and connect it as shown in Figure 16A. Pull the free end of the strap away from the buckle to make a snug fit on each leg strap. To loosen the leg strap, grasp the buckle and pull away from your leg to allow the strap to pull through the buckle. A plastic end keeper on the end of the strap will stop it from pulling completely out of the buckle. To release the buckle. Repeat this procedure for the right side.
- Step 4.** Adjust the waist belt by inserting the buckle tongue into the grommet on the left side as shown in Figure 16A.
- Step 5.** Attach the chest strap by connecting the buckle. See Figure 16A. Chest strap should be six inches down from the top of shoulders. Pass excess strap through the loop keepers. The strap may be tightened to a snug fit by pulling the free strap end to the left (away from the buckle). To loosen the chest strap, grasp the buckle and pull away from the body to allow the strap to pull through the buckle. A plastic end keeper on the end of the strap will stop it from pulling completely out of the buckle.
- Step 6.** Adjust shoulder straps to a snug fit (Figure 16B). Left and right sides of shoulder straps should be adjusted to the same length and the chest strap should be centered on your lower chest, six inches down from shoulder. The front D-ring on vest style harness is moved up or down by adjusting the shoulder straps and leg straps. Center the back D-ring between shoulder blades. Adjust leg straps to a snug fit. At least three inches of webbing must extend past buckle on leg straps. Adjust the waist belt (if present). Center retrieval D-rings (if present) on top of each shoulder.

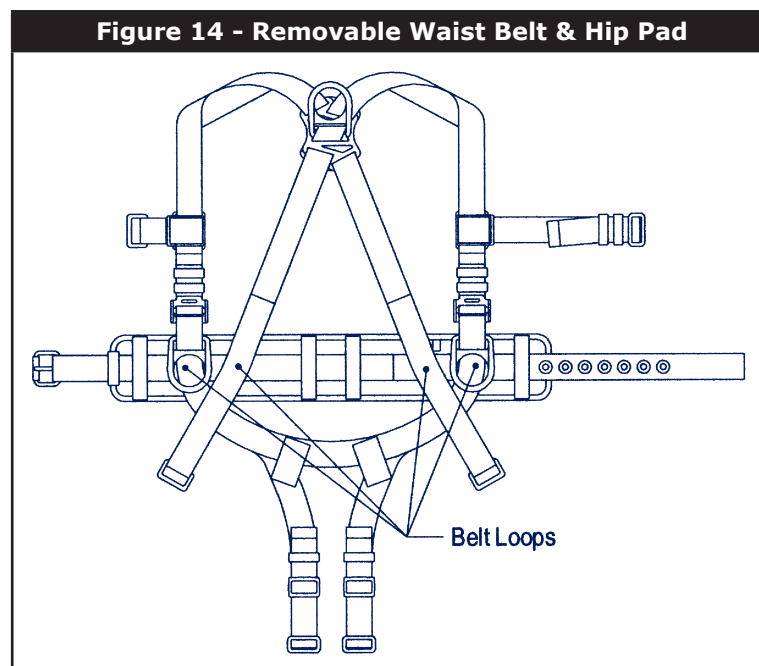
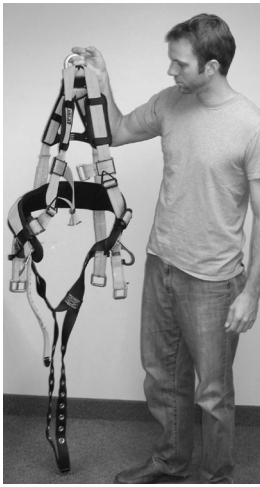

Figure 15 - Donning Vest Style Harness



Step 1



Step 2



Step 3



Step 4

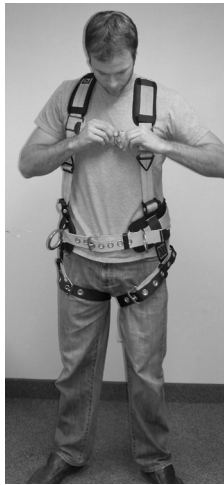

Step 5



Step 6

Figure 16A - Vest Style Harness Buckle Connections



Chest Strap: Pass male buckle through female buckle and pull free end of webbing to tighten.



Chest Strap: Attach chest strap by inserting the tab of the buckle into the receptor of the quick connect buckle until a click is heard.



Tongue Buckle: Pass webbing through buckle and insert tongue through grommet.



Pass Buckle: Pass male buckle through female buckle and pull free end of webbing to tighten.

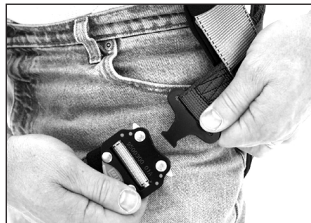

Quick Connect Buckle: Insert the tab of the buckle into the receptor of the quick connect buckle until a click is heard.

16B - Revolver™ Vertical Torso Adjusters

Right

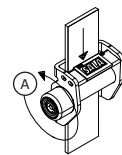

To Tighten: Turn Ratchet Knob in direction **A**.

To Loosen: Pull Ratchet Knob out and turn in direction **B**.

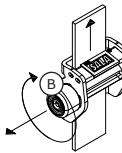

NOTE: After adjustment, tug upwards on the shoulder straps to ensure that each adjuster is locked in place.

Left

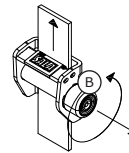
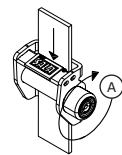

CROSS-OVER STYLE HARNESS:

If your harness incorporates loops for a removable waist belt, the belt should be installed through the four loops in the harness as shown in Figure 17. The hip pad, if used, is secured to the belt by passing the belt through the hip pad loops. Don the cross-over style full body harness by following these steps (see Figures 17-19B):

NOTE: Cross-Over Style harnesses contain different harness buckle connections. See Figure 19A for the style that applies to your harness.

- Step 1.** Locate back D-ring held in position by the D-ring pad; lift up harness and hold by this D-ring. Ensure the straps are not twisted.
- Step 2.** Grasp shoulder straps between back and front D-ring and slip harness over your head from the left side. Position shoulder straps on top of shoulder. Ensure straps are not tangled and hang freely. The D-ring will be positioned on your back when worn properly.
- Step 3.** Grasp the buckle below the front D-ring and connect (Figure 19A). Ensure straps are not tangled or crossed.
- Step 4.** Reach between legs and grasp blue leg strap on your left side. Bring strap up between legs and connect to buckle. Connect right leg strap (Figure 19A).
- Step 5.** Adjust shoulder straps to a snug fit (Figure 19B). Left and right sides of shoulder straps should be adjusted to the same length and the front D-ring should be centered on your lower chest. The back D-ring should be centered between your shoulder blades. Adjust leg straps to a snug fit. Adjust the waist belt (if present). Center retrieval D-rings (if present) on top of each shoulder.

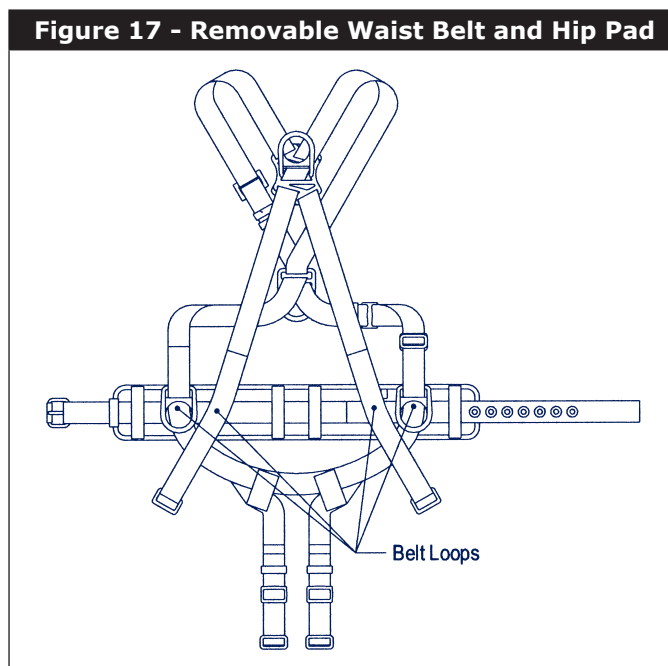

- 3.4 USE OF FALL ARREST D-RING OR ATTACHMENT ELEMENT:** For fall protection applications connect to the D-ring or attachment element on your back, between your shoulder blades. Side D-rings, if present, are for positioning or restraint applications only. Shoulder retrieval D-rings are for rescue or retrieval applications only. Front D-ring is for ladder climbing or positioning. D-rings on seat sling are for suspension or positioning applications only.
- 3.5 MAKING CONNECTIONS:** When using a hook to connect to an anchorage or when coupling components of the system together, ensure roll-out cannot occur. Roll-out occurs when interference between the hook and mating connector causes the hook gate to unintentionally open and release. Self-locking snap hooks and carabiners should be used to reduce the possibility of roll-out. Do not use hooks or connectors that will not completely close over the attachment object. See subsystem manufacturer's instructions for more information on making connections.
- 3.6 CONNECTING SYSTEM COMPONENTS:** After fitting the full body harness the user may then connect to other system components. Follow the guidelines in section 3.4 on selecting the correct attachment element.

Figure 18 - Donning Cross-over Style Harness



Step 1

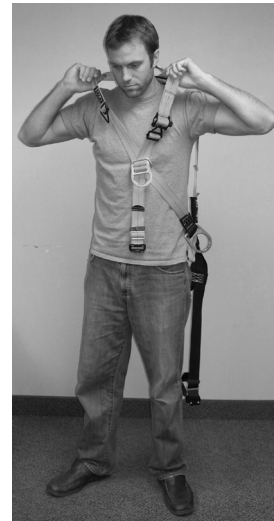

Step 2



Step 3



Step 4



Step 5

Figure 19A - Cross-over Style Harness Buckle Connections



Tongue Buckle: Pass webbing through buckle and insert tongue through grommet.



Quick Connect Buckle: Insert the tab of the buckle into the receptor of the quick connect buckle until a click is heard.



Pass Buckle: Pass male buckle through female buckle and pull free end of webbing to tighten.

Figure 19B - Revolver Torso Adjuster

To Tighten: Turn Ratchet Knob in direction **A**.

To Loosen: Pull Ratchet Knob out and turn in direction **B**.

NOTE: After adjustment, tug upwards on the shoulder straps to ensure that each adjuster is locked in place.

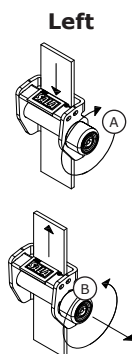

4.0 TRAINING

- 4.1** It is the responsibility of the user and the purchaser of this equipment to assure that they are familiar with these instructions, trained in the correct care and use of, and are aware of the operating characteristics, application limits, and the consequences of improper use of this equipment.

IMPORTANT: Training must be conducted without exposing the user to a fall hazard. Training should be repeated on a periodic basis.

5.0 INSPECTION

- 5.1** The i-Safe™ RFID tag on this harness can be used in conjunction with the i-Safe handheld reading device and the web based portal to simplify inspection and inventory control and provide records for your fall protection equipment See Figure 20.
- 5.2 FREQUENCY:** Before each use inspect the full body harness according to sections 5.3 and 5.4. The harness must also be inspected by a competent person, other than the user, at least annually. Record the results of each Competent Person inspection in the inspection and maintenance log in section 9.0, or use the i-Safe™ inspection web portal to maintain your inspection records. If you are a first-time user, contact a Customer Service representative (See Back Cover) or if you have already registered, access isafe.capitalsafety.com. Follow instructions provided with your i-Safe handheld reader or on the web portal to transfer your data to your web log.

IMPORTANT: If the full body harness has been subjected to fall arrest or impact forces it must be immediately removed from service and destroyed.

IMPORTANT: Extreme working conditions (harsh environments, prolonged use, etc.) may require increasing the frequency of inspections.

5.3 INSPECTION STEPS:

- Step 1.** Inspect harness hardware (buckles, D-rings, back pad, loop keepers); These items must not be damaged, broken, distorted, and must be free of sharp edges, burrs, cracks, worn parts, or corrosion. PVC coated hardware must be free of cuts, rips, tears, holes, etc. in the coating to ensure non-conductivity. Ensure buckles work smoothly. If present, inspect the quick connect buckles by ensuring that the release tabs work freely and that a click is heard when the buckle engages. Inspect parachute buckle spring.
- Step 2.** Inspect webbing; material must be free of frayed, cut, or broken fibers. Check for tears, abrasions, mold, burns, or discoloration. Inspect stitching; Check for pulled or cut stitches. Broken stitches may be an indication that the harness has been impact loaded and must be removed from service.
- IMPORTANT:** On Delta Vest™ harnesses, inspection should include the webbing inside the vest.
- Step 3.** Inspect labels; All labels should be present and fully legible. See section 8.0.
- Step 4.** Inspect each system component or subsystem according to manufacturer's instructions.
- Step 5.** Inspect the Stitched Impact Indicator (Figure 21): The Stitched Impact Indicator (A) is a section of webbing that is lapped back on itself and secured with a specific stitch pattern holding the lap. The stitch pattern is designed to release when the harness arrests a fall or has been subjected to an equivalent force. If the impact indicator has been activated the harness must be removed from service and destroyed.

NOTE: Some harnesses are equipped with a "stand up D-ring" in the dorsal (back) D-ring location. If the spring in the D-ring is damaged or lost and the D-ring no longer stands up, this does not compromise the harness integrity. As long as the D-ring passes inspection criteria in Step 1, it is safe to use.

Figure 20 - i-Safe™ RFID Tag

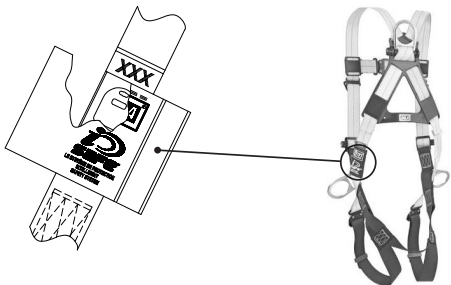
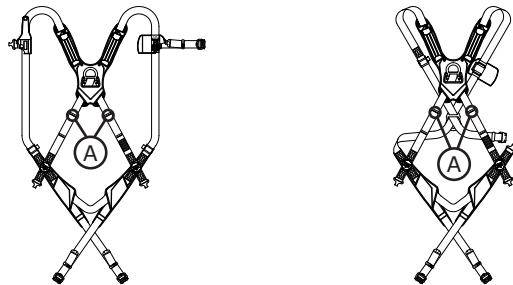

Figure 21 - Stitched Impact Indicator



5.4 DEFECTS: If inspection reveals a defective condition, remove unit from service immediately and destroy.

NOTE: Only DBI-SALA or parties authorized in writing may make repairs to this equipment.

5.5 PRODUCT LIFE: The functional life of DBI-SALA harnesses is determined by work conditions and maintenance. As long as the product passes inspection criteria, it may remain in service.

6.0 MAINTENANCE, SERVICING, STORAGE

6.1 WASHING INSTRUCTIONS:

Full body harness: Clean full body harness with water and a mild soap solution. Do not use bleach or bleach solutions. Wipe off hardware with a clean, dry cloth, and hang to air dry. Do not force dry with heat. An excessive buildup of dirt, paint, etc. may prevent the full body harness from working properly, and in severe cases degrade the webbing to a point where it weakens and should be removed from service. More information on cleaning is available from DBI-SALA. If you have questions concerning the condition of your harness, or have any doubt about putting it into service contact DBI-SALA.

Fire Resistant Padding:

- Remove pads from harness for laundering. Place the harness in the supplied laundry bag. The bag is designed to prevent entanglement of harness and to protect the washing machine from damage. Use of the laundry bag to wash the pads is optional.
- Launder flame resistant pads separately from harness or other non-flame resistant garments. Lint from other garments may affect flame resistance.
- Use a bleach-free detergent when washing both the harness and the pads. Do not use soap; soap may leave a residue which could affect flame resistance.
- Do not use chlorine bleach. Bleach may weaken fabric and reduce product life.
- Oily or greasy stains may be pre-treated and washed in hot water 140°F max (60°C max).
- Use delicate, permanent press, or cotton sturdy wash cycle with cold or warm water. Hot water can be used on heavily soiled items as long as it does not exceed 140°F (60°C). Use extra rinse cycle to be sure all residual wash chemicals are removed.
- Air dry or tumble dry using permanent press cycle and low heat. Drying temp should not exceed 200°F (93°C). These fabrics dry quickly, for lowest shrinkage, do not over dry.

6.2 Additional maintenance and servicing procedures must be completed by a factory authorized service center. Authorization must be in writing. Do not attempt to disassemble the unit.

6.3 Store full body harnesses in a cool, dry, clean environment out of direct sunlight. Avoid areas where chemical vapors may exist. Thoroughly inspect the full body harness after extended storage.

7.0 SPECIFICATIONS

7.1 PERFORMANCE

Maximum Free Fall Distance: No greater than 6 feet (1.8 m), per federal law and ANSI Z359.1.

Maximum Arresting Force: 1,800 lbs. (8 kN)

Capacity: ANSI Z359.1--310 lbs (141 kg), CSA Z259.10---352 lbs (160 kg)

Approximate Weight:

- Harness only: 3 lbs. (1.4 kg)
- Harness with Side D-rings: Add 1/2 lb. (.23 kg)
- Harness with Back Pad or Belt: Add 1 lb. (.45 kg)

Cross-over Style Harness Patent numbers: United States: 5,203,829, Canada: 2,080,643

All harnesses, excluding Kevlar harnesses, meet ANSI Z359.1 and OSHA requirements.

7.1 MATERIALS

Standards: All harnesses marked with ASTM F887-2004 meet all testing requirements of the standard.

Webbing Materials: 6,000 lbs (27kN) Tensile Strength Polyester; 7,000 lbs (31 kN) Tensile Strength Nylon; 7,000 lbs. (31 kN) Tensile Strength Nomex™ covered Kevlar™.

Pad and Label Cover Materials:





- All outer fabric is Nomex and Kevlar blend fabric
- Fire resistant hook and loop fasteners

Optional Accessories:

- Hip Pad with side D-ring
- Nomex covered Kevlar webbing
- Non-sparking/ Non-conductive PVC coated hardware
- Arc-rated hip, leg, and back pads
- Polyurethane coated, arc-rated dorsal web loop

8.0 LABELING

8.1 The following labels must be present and completely legible:

ANSI	CSA
 <p>RFID Tag</p>	 <p>RFID Tag</p>
 <p>Size Label</p>	 <p>Size Label</p>
<p>950340 Rev. C</p> <p>WARNING MANUFACTURER'S INSTRUCTIONS MUST BE READ AND UNDERSTOOD PRIOR TO USE. INSTRUCTIONS SUPPLIED WITH THIS PRODUCT AT TIME OF SHIPMENT MUST BE FOLLOWED. FAILURE TO DO SO COULD RESULT IN SERIOUS INJURY OR DEATH. CONTACT DBI-SALA IF INSTRUCTION SHEET IS NEEDED. INSPECT BEFORE EACH USE. DO NOT USE IF WEAR OR DAMAGE IS PRESENT. THIS BODY HARNESS IS INTENDED TO BE USED TO ARREST THE MOST SEVERE FREE FALLS. ITEMS SUBJECTED TO FALL ARREST OR IMPACT FORCES MUST BE IMMEDIATELY REMOVED FROM SERVICE AND DESTROYED. CONNECTING SNAP AND D-RING MUST BE COMPATIBLE IN SIZE, SHAPE, AND STRENGTH. THIS ITEM IS NOT FLAME OR HEAT RESISTANT. REPAIRS ONLY TO BE PERFORMED BY DBI-SALA. EQUIPMENT MODIFICATION OR MISUSE VOIDS WARRANTY.</p>	<p>Full Body Harness Harnois de sécurité</p> <p>www.capitalsafety.com USA: (800) 328-6146 Canada: (800) 387-7484</p> <p>Polyester web Sangle polyester</p> <p>Size: See Label Grandeur: Voir étiquette</p> <p>Do not remove label Ne pas enlever cette étiquette</p> <p>Made in Canada Fabriqué au Canada</p> <p>CSA STANDARD Z259.10-06</p>
<p>950340 Rev. C</p> <p>WARNING MANUFACTURER'S INSTRUCTIONS MUST BE READ AND UNDERSTOOD PRIOR TO USE. INSTRUCTIONS SUPPLIED WITH THIS PRODUCT AT TIME OF SHIPMENT MUST BE FOLLOWED. FAILURE TO DO SO COULD RESULT IN SERIOUS INJURY OR DEATH. CONTACT DBI-SALA IF INSTRUCTION SHEET IS NEEDED. INSPECT BEFORE EACH USE. DO NOT USE IF WEAR OR DAMAGE IS PRESENT. THIS BODY HARNESS IS INTENDED TO BE USED TO ARREST THE MOST SEVERE FREE FALLS. ITEMS SUBJECTED TO FALL ARREST OR IMPACT FORCES MUST BE IMMEDIATELY REMOVED FROM SERVICE AND DESTROYED. CONNECTING SNAP AND D-RING MUST BE COMPATIBLE IN SIZE, SHAPE, AND STRENGTH. THIS ITEM IS NOT FLAME OR HEAT RESISTANT. REPAIRS ONLY TO BE PERFORMED BY DBI-SALA. EQUIPMENT MODIFICATION OR MISUSE VOIDS WARRANTY.</p> <p>DO NOT EXCEED CAPACITY OF THIS OR OTHER SYSTEM COMPONENTS. CAPACITY IS THE COMBINED WEIGHT FOR WHICH THE COMPONENT IS DESIGNED TO BE USED. COMBINED WEIGHT INCLUDES THE USER'S BODY WEIGHT, CLOTHING, TOOLS, AND ANY OBJECTS CARRIED. CONTACT DBI-SALA FOR MORE INFORMATION.</p>	<p>950347 Rev. B</p> <p>WARNING/AVERTISSEMENT!</p> <p>Any unit which has seen a fall arresting service should not be used after such service. Before use, read and comply with all labels and separate instructions. Failure to do so could result in serious injury or death. Contact Capital Safety if written instruction sheet is needed. Inspect before each use. If wear damage exists, do not use. This body harness is intended to be used to arrest the most severe falls. Connecting strap and D-ring must be compatible in size, shape and strength. This item is not flame or heat resistant. Repairs only to be performed by Capital Safety Group. Equipment modification or misuse voids warranty. On ne doit pas utiliser un dispositif après qu'il a servi à arrêter une chute. Avant de l'utiliser, on doit lire et observer les instructions sur toutes les étiquettes et dans les autres documents. Négliger de le faire peut causer des blessures graves, voire mortelles. Consultez avec Capital Safety si on a besoin d'une fiche d'instructions. Inspecter avant chaque utilisation. Si il y a des dommages dus à de l'usage, ne pas utiliser. Ce harnois de sécurité est destiné à être utilisé pour arrêter les plus chutes. Le remplacement et l'ajout de matériel doivent être compatibles en taille, forme et résistance. Ce dispositif ne réside pas aux flammes ou à la chaleur. Les réparations doivent être effectuées seulement par le Capital Safety Group. Une modification ou un usage abusif de l'équipement annule la garantie.</p>
<p>950340 Rev. C</p> <p>WARNING MANUFACTURER'S INSTRUCTIONS MUST BE READ AND UNDERSTOOD PRIOR TO USE. INSTRUCTIONS SUPPLIED WITH THIS PRODUCT AT TIME OF SHIPMENT MUST BE FOLLOWED. FAILURE TO DO SO COULD RESULT IN SERIOUS INJURY OR DEATH. CONTACT DBI-SALA IF INSTRUCTION SHEET IS NEEDED. INSPECT BEFORE EACH USE. DO NOT USE IF WEAR OR DAMAGE IS PRESENT. THIS BODY HARNESS IS INTENDED TO BE USED TO ARREST THE MOST SEVERE FREE FALLS. ITEMS SUBJECTED TO FALL ARREST OR IMPACT FORCES MUST BE IMMEDIATELY REMOVED FROM SERVICE AND DESTROYED. CONNECTING SNAP AND D-RING MUST BE COMPATIBLE IN SIZE, SHAPE, AND STRENGTH. THIS ITEM IS NOT FLAME OR HEAT RESISTANT. REPAIRS ONLY TO BE PERFORMED BY DBI-SALA. EQUIPMENT MODIFICATION OR MISUSE VOIDS WARRANTY.</p> <p>DO NOT EXCEED CAPACITY OF THIS OR OTHER SYSTEM COMPONENTS. CAPACITY IS THE COMBINED WEIGHT FOR WHICH THE COMPONENT IS DESIGNED TO BE USED. COMBINED WEIGHT INCLUDES THE USER'S BODY WEIGHT, CLOTHING, TOOLS, AND ANY OBJECTS CARRIED. CONTACT DBI-SALA FOR MORE INFORMATION.</p>	<p>950347 Rev. B</p> <p>WARNING MANUFACTURER'S INSTRUCTIONS MUST BE READ AND UNDERSTOOD PRIOR TO USE. INSTRUCTIONS SUPPLIED WITH THIS PRODUCT AT TIME OF SHIPMENT MUST BE FOLLOWED. FAILURE TO DO SO COULD RESULT IN SERIOUS INJURY OR DEATH. CONTACT CAPITAL SAFETY IF INSTRUCTION SHEET IS NEEDED. INSPECT BEFORE EACH USE. REMOVE FROM SERVICE AFTER FALL ARREST. REMOVE FROM SERVICE IF WEAR DAMAGE IS PRESENT DURING INSPECTION. MAKE ONLY COMPATIBLE CONNECTIONS. DO NOT ALTER OR REPAIR HARNESS.</p> <p>AVERTISSEMENTS LES INSTRUCTIONS DU FABRICANT DOIVENT ETRE LUES ET COMPRIS PREALABLEMENT A L'UTILISATION. LES INSTRUCTIONS FOURNIES AVEC CE PRODUIT AU MOMENT DE L'EXPEDITION DOIVENT ETRE SUIVIES. NEGLIGER CES RECOMMANDATIONS PEUT ENTRAINER DES BLESSURES GRAVES, VOIRE MORTELLES. CONTACTER CAPITAL SAFETY EN CAS DE BESOIN DE NOTICE. INSPECTER AVANT CHAQUE UTILISATION. METTRE HORS SERVICE APRES L'ARRET D'UNE CHUTE. METTRE HORS SERVICE SI L'INSPECTION REVELE DES DOMMAGES DUS A L'USURE. EFFECTUER SEULEMENT DES FIXATIONS COMPATIBLES. NE PAS MODIFIER OU REPARER LE HARNAIS.</p>
<p>950340 Rev. B</p> <p>PRODUCT COMPLIANCE</p> <p>THIS PRODUCT COMPLIES WITH THE FOLLOWING STANDARDS ONLY IF MARKED WITH THE CORRESPONDING LETTER CODE UNDER "STDS" SECTION BELOW.</p> <p>A = ANSI Z359.1 B = OSHA C = ANSI A10.32-2004 D = ASTM F887-2005 E = ANSI Z359.3 F = ANSI Z359.4</p> <p>MFRD/(YR)MO; LOT; MODEL NO.; STDS:</p> <p>950340 Rev. B</p> <p>INSPECTION LOG</p> <p>DO NOT REMOVE THIS LABEL</p>	<p>950347 Rev. A</p> <p>INSPECTION LOG</p> <p>RELIEVE D'INSPECTION</p> <p>SERIAL NO. NUMERO DE SERIE: SEE RFID TAG IN CLEAR POUCH VOIR L'ETIQUETTE DE RFID DANS LA POCHES TRANSPARENT</p> <p>MFRD/LOT/FABR. LOT: (YR)MO/(AA)MM</p> <p>MODEL NO./MODÈLE</p>

This instruction applies to the following models:

1100373	1100936	1101821	1102951	1104915	1107852	1110601	1112377
1100374	1100937	1101822	1102952	1105331	1107859	1110601H	1112401
1100379	1100938	1101826	1102955	1105332	1107860	1110602	1112402
1100380	1101251	1101827	1102957	1105333	1107861	1110603	1112404
1100389	1101251H	1101828	1102972	1105900	1107862	1110605	1112450
1100390	1101252	1101829	1103104	1105901	1108025	1110606	1112450H
1100391	1101252H	1101830	1103104H	1105925	1108026	1110606H	1112451
1100392	1101253	1101831	1103109H	1105926	1108125	1110608	1112452
1100393	1101253H	1101838	1103251	1105975	1108126	1110618	1112453
1100394	1101254	1101839	1103252	1105996	1108127	1110618H	
1100395	1101254H	1101840	1103253	1106015	1108128	1110625	
1100396	1101255	1101841	1103254	1106020	1108129	1110626	
1100517	1101255H	1101842	1103255	1106023	1108130	1110627	
1100518	1101256	1101843	1103256	1106024	1108131	1110628	
1100519	1101257	1101844	1103257	1106025	1108132	1110700	
1100523	1101258	1101846	1103258	1106028	1108133	1110701	
1100632	1101258H	1101847	1103259	1106028H	1108134	1110702	
1100633	1101261	1101854	1103260	1106035	1108135	1110704	
1100634	1101263	1101855	1103261	1106040	1108175	1110725	
1100635	1101264	1101856	1103262	1106041	1108176	1110726	
1100636	1101265	1101857	1103263	1106055	1108177	1110727	
1100637	1101266	1101858	1103265	1106066	1108178	1111000	
1100638	1101267	1101858H	1103266	1106081	1108179	1111001	
1100639	1101268	1101860	1103270	1106089	1108180	1111002	
1100680	1101271	1101862	1103321	1106092	1108181	1111003	
1100681	1101637	1101871	1103375	1106092H	1108182	1111004	
1100682	1101639	1102000	1103376	1106097H	1108183	1111100	
1100683	1101640	1102000H	1103377	1106098H	1108184	1111101	
1100696	1101649	1102001	1103378	1106180	1108185	1111102	
1100697	1101653	1102008	1103379	1107000	1108186	1111103	
1100698	1101653H	1102008H	1103380	1107001	1108187	1111104	
1100699	1101654	1102010	1103382	1107002	1108188	1112000	
1100700	1101654H	1102020	1103383	1107003	1108190	1112001	
1100701	1101655	1102021	1103384	1107004	1108192	1112002	
1100702	1101655H	1102022	1103385	1107005	1108302	1112003	
1100703	1101656	1102090	1103386	1107075	1108305	1112004	
1100745	1101656H	1102091	1103393	1107651	1108311	1112007	
1100746	1101659	1102092	1103394	1107653	1109040	1112008	
1100747	1101660	1102093	1103395	1107656	1109050	1112009	
1100748	1101661	1102186	1103511	1107658	1109052	1112010	
1100785	1101662	1102187	1103513	1107726	1109062	1112011	
1100786	1101662H	1102188	1103513H	1107774	1109107	1112026	
1100787	1101776	1102189	1103875	1107775	1109142	1112027	
1100788	1101781	1102195H	1103876	1107776	1109400	1112050	
1100795	1101783	1102196H	1103877	1107777	1109449	1112051	
1100796	1101784	1102197H	1103878	1107778	1109980	1112052	
1100797	1101785	1102198H	1103879	1107800	1109981	1112053	
1100798	1101786	1102199H	1104625	1107800H	1109982	1112075	
1100821	1101787	1102200	1104626	1107801	1109983	1112082	
1100822	1101791	1102201	1104627	1107802	1109984	1112125	
1100823	1101794	1102201H	1104628	1107803	1110575	1112126	
1100824	1101796	1102205	1104629	1107803H	1110575H	1112127	
1100834	1101800	1102206	1104632	1107804	1110576	1112128	
1100835	1101801	1102220H	1104633	1107805	1110576H	1112129	
1100836	1101802	1102221H	1104635	1107806	1110577	1112150	
1100837	1101803	1102249	1104636	1107806H	1110577H	1112174	
1100840	1101805	1102258	1104875	1107807	1110578	1112175	
1100841	1101806	1102259	1104875H	1107807H	1110578H	1112176	
1100842	1101807	1102260	1104876	1107809	1110582	1112177	
1100845	1101808	1102336H	1104877	1107810	1110582H	1112178	
1100846	1101809	1102337H	1104878	1107811	1110586	1112179	
1100847	1101810	1102338H	1104879	1107812	1110587	1112180	
1100848	1101811	1102339H	1104880	1107813	1110588	1112228	
1100881	1101812	1102515	1104881	1107814	1110589	1112252	
1100882	1101813	1102516	1104882	1107815	1110589H	1112330	
1100883	1101814	1102517	1104883	1107817	1110590	1112331	
1100884	1101815	1102518	1104886	1107817H	1110591	1112332	
1100885	1101816	1102519	1104887	1107818	1110592	1112333	
1100886	1101817	1102695	1104888	1107818H	1110593	1112334	
1100887	1101818	1102695H	1104889	1107819	1110594	1112350	
1100888	1101819	1102950	1104907	1107850	1110600	1112375	
1100935	1101820	1102950H	1104911	1107851	1110600H	1112376	

INSPECTION AND MAINTENANCE LOG

SERIAL NUMBER:			
MODEL NUMBER:			
DATE PURCHASED:		DATE OF FIRST USE:	

INSPECTION DATE	INSPECTION ITEMS NOTED	CORRECTIVE ACTION	MAINTENANCE PERFORMED
Approved By:			
Approved By:			
Approved By:			
Approved By:			
Approved By:			
Approved By:			
Approved By:			
Approved By:			
Approved By:			
Approved By:			
Approved By:			
Approved By:			
Approved By:			
Approved By:			
Approved By:			

LIMITED LIFETIME WARRANTY

Warranty to End User: D B Industries, Inc., dba CAPITAL SAFETY USA ("CAPITAL SAFETY") warrants to the original end user ("End User") that its products are free from defects in materials and workmanship under normal use and service. This warranty extends for the lifetime of the product from the date the product is purchased by the End User, in new and unused condition, from a CAPITAL SAFETY authorized distributor. CAPITAL SAFETY'S entire liability to End User and End User's exclusive remedy under this warranty is limited to the repair or replacement in kind of any defective product within its lifetime (as CAPITAL SAFETY in its sole discretion determines and deems appropriate). No oral or written information or advice given by CAPITAL SAFETY, its distributors, directors, officers, agents or employees shall create any different or additional warranties or in any way increase the scope of this warranty. CAPITAL SAFETY will not accept liability for defects that are the result of product abuse, misuse, alteration or modification, or for defects that are due to a failure to install, maintain, or use the product in accordance with the manufacturer's instructions.

CAPITAL SAFETY'S WARRANTY APPLIES ONLY TO THE END USER. THIS WARRANTY IS THE ONLY WARRANTY APPLICABLE TO OUR PRODUCTS AND IS IN LIEU OF ALL OTHER WARRANTIES AND LIABILITIES, EXPRESSED OR IMPLIED. CAPITAL SAFETY EXPRESSLY EXCLUDES AND DISCLAIMS ANY IMPLIED WARRANTIES OF MERCHANTABILITY OR FITNESS FOR A PARTICULAR PURPOSE, AND SHALL NOT BE LIABLE FOR INCIDENTAL, PUNITIVE OR CONSEQUENTIAL DAMAGES OF ANY NATURE, INCLUDING WITHOUT LIMITATION, LOST PROFITS, REVENUES, OR PRODUCTIVITY, OR FOR BODILY INJURY OR DEATH OR LOSS OR DAMAGE TO PROPERTY, UNDER ANY THEORY OF LIABILITY, INCLUDING WITHOUT LIMITATION, CONTRACT, WARRANTY, STRICT LIABILITY, TORT (INCLUDING NEGLIGENCE) OR OTHER LEGAL OR EQUITABLE THEORY.



The Ultimate in Fall Protection

CSG USA & Latin America

3833 SALA Way
Red Wing, MN 55066-5005
Toll Free: 800.328.6146
Phone: 651.388.8282
Fax: 651.388.5065
solutions@capitalsafety.com

CSG Canada

260 Export Boulevard
Mississauga, ON L5S 1Y9
Phone: 905.795.9333
Toll-Free: 800.387.7484
Fax: 888.387.7484
info.ca@capitalsafety.com

CSG Northern Europe

5a Merse Road
North Moons, Moat
Reditch, Worcestershire, UK
B98 9HL
Phone: + 44 (0)1527 548 000
Fax: + 44 (0)1527 591 000
csgne@capitalsafety.com

CSG EMEA (Europe, Middle East, Africa)

Le Broc Center
Z.I. 1ère Avenue
5600 M B.P. 15 06511
Carros
Le Broc Cedex
France
Phone: + 33 4 97 10 00 10
Fax: + 33 4 93 08 79 70
information@capitalsafety.com

CSG Australia & New Zealand

95 Derby Street
Silverwater
Sydney NSW 2128
AUSTRALIA
Phone: +(61) 2 8753 7600
Toll-Free : 1 800 245 002 (AUS)
Toll-Free : 0800 212 505 (NZ)
Fax: +(61) 2 8753 7603
sales@capitalsafety.com.au

CSG Asia

Singapore:
16S, Enterprise Road
Singapore 627666
Phone: +65 - 65587758
Fax: +65 - 65587058
inquiry@capitalsafety.com

Shanghai:

Rm 1406, China Venturetech Plaza
819 Nan Jing Xi Rd,
Shanghai 200041, P R China
Phone: +86 21 62539050
Fax: +86 21 62539060

www.capitalsafety.com

