

Enerpac hydraulic cylinders are available in hundreds of different configurations. Whatever the industrial application... lifting, pushing, pulling, bending, holding... whatever the force capacity, stroke length, or size restrictions... single- or double-acting, solid or hollow plunger, you can be sure that Enerpac has the cylinder to suit your high force application.

Enerpac jacking cylinders fully comply to ASME B30.1 (except RD-Series).



### GR2 Bearing Technology

The exclusive GR2 is a unique bearing design on RC-Series DUO cylinders which absorbs eccentric load stresses to protect your cylinder against abrasion, over-extending or plunger blow-outs and jamming or top-end mushrooming. As a result, RC-Series DUO cylinders provide long, trouble-free operation.



Easy assembly and disassembly using only standard shop tools.

Heavy-duty, pre-tensioned spring improves retraction rate for enhanced productivity.













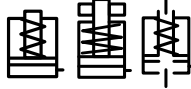



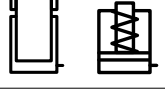



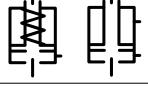







Unique GR2 Bearing System surrounds the seal of longer stroke models resulting in improved side-load resistance and extended operating life.

Additional shape and texture to the cylinder thread protector and pliable plug-in/pop-off coupler cap for easy operation with gloved and oily hands.

Note: The cut-away drawing is representative of typical cylinder construction and may not represent all cylinders in this section.



# Cylinder & Lifting Products Section Overview

* Capacity (tons)	Stroke Range (in)	Cylinder Type and Functions	Series		Page
5-100	.63-14.25	General Purpose Cylinders, Single-acting Cylinder Accessories 	RC-DUO		6 ▶ 10 ▶
20-150	1.97-9.84	Aluminum Cylinders Single-Acting, Solid Plunger, Lock Nut, Hollow Plunger 	RAC RACL RACH		12 ▶ 14 ▶ 16 ▶
20-150	1.97-9.84	Aluminum Cylinders Double-Acting Solid Plunger 	RAR		18 ▶
5-500	.25-2.44	Pancake and Low Height Cylinders, Single-Acting 	LPL RSM RCS		20 ▶ 22 ▶ 23 ▶
2.5-60	5.00-6.00	Pull Cylinders, Single-Acting 	BRC BRP		24 ▶
12-150	.31-10.13	Hollow Plunger Cylinders Single- and Double-Acting 	RCH RRH		26 ▶ 28 ▶
4-25	1.13-10.25	Precision Production Cylinders, Double-Acting 	RD		30 ▶
10-500	2.25-48.00	Long Stroke Cylinders, Double-Acting 	RR		32 ▶
50-1000	1.97-11.81	High Tonnage Cylinders Single-Acting (S/A), S/A with Mechanical Locknut, Double-Acting 	HCG HCR HCL		36 ▶ 44 ▶ 48 ▶
5-100	1.50-14.25	Cylinder - Pump Sets (Single-Acting) 	SC		52 ▶
5-25	2.0-6.0	Extreme Environment Products (Valves, cylinders, hand pumps)	RC P V		54 ▶
5-50	.44-10.13	Portable Hydraulic Toolbox	SCR SCL SRS		55 ▶
7-150 2-100	3.00-6.13 2.44-18.11	Aluminum and Steel Jacks Industrial Bottle Jack 	JH/JHA GBJ		56 ▶ 57 ▶
60-200	14.0-27.0	POW'R-RISER® Lifting Jack 	PR		58 ▶
200	14.0 / 24.5	Pow'R-LOCK™ Portable Lift System	PL		60 ▶
55-220	5.91-6.34	Climbing Jacks	BLS		62 ▶
60-250	19.69-59.06	Synchronous Hoisting Systems	SHS SHAS		64 ▶

\* All cylinder capacities are nominal values, unless otherwise stated. [Maximum] capacities are theoretical and may vary, depending on cylinder condition and application.

▼ Shown from left to right: RC-506, RC-50, RC-2510, RC-154, RC-10010, RC-55, RC-1010



- Unique GR2 Bearing Design, reduces wear, extending life
- Collar threads, plunger threads and base mounting holes enable easy fixturing (on most models)
- Designed for use in all positions
- High strength alloy steel for durability
- Redesigned cylinder thread protector for ease of use
- Heavy-duty, pretensioned spring improves retraction speed
- Baked enamel finish for increased corrosion resistance
- CR-400 coupler and dust cap included on all models
- Plunger wiper reduces contamination, extending cylinder life

## The Industry Standard General Purpose Cylinder



### Saddles

All RC cylinders (except RC-50, 101) are equipped with hardened removable grooved saddles. For tilt and flat saddles, see the RC-Series accessory page.

Page: 10

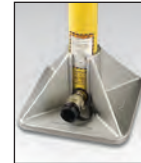

### Base Plates

To ensure the stability of cylinders for lifting applications, base plates are available for 10, 25 and 50 ton RC cylinders.

Page: 10



### Specialty Attachments

For solving all kinds of application problems, specialty attachments are available for 5, 10 and 25 ton RC cylinders.

Page: 187

▼ To re-stabilize the foundation, the 308-ton silo needed to be lifted, levelled and structurally supported. Twenty-five ton RC-Series hydraulic cylinders were attached to a bracket on the top of each steel pier. Powered by a Z-Class pump, the hydraulic cylinders applied 20 tons of force at each placement to lift the silo two inches.



▼ RC cylinder mounting attachments greatly extend the application possibilities (available for 5, 10, 15 and 25 ton cylinders).



# Single-Acting, General Purpose Cylinders



## GR2 Bearing Technology

The exclusive GR2 is a unique bearing design on RC-Series DUO cylinders which absorbs eccentric load stresses to protect your cylinder against abrasion, over-extending or plunger blow-outs and jamming or top-end mushrooming. As a result, RC-Series DUO cylinders provide long, trouble-free operation.

### ▼ QUICK SELECTION CHART

For complete technical information see next page.

Cylinder Capacity	Stroke	Model Number	Cylinder Effective Area	Oil Capacity	Collapsed Height	Weight
tons (maximum)	(in)		(in <sup>2</sup> )	(in <sup>3</sup> )	(in)	(lbs)
5 (4.9)	.63	RC-50**	.99	.62	1.63	2.2
	1.00	RC-51	.99	.99	4.34	2.3
	3.00	RC-53	.99	2.98	6.50	3.3
	5.00	RC-55*	.99	4.97	8.50	4.1
	7.00	RC-57	.99	6.96	10.75	5.3
	9.13	RC-59	.99	9.07	12.75	6.1
10 (11.2)	1.00	RC-101	2.24	2.24	3.53	4.0
	2.13	RC-102*	2.24	4.75	4.78	5.1
	4.13	RC-104	2.24	9.23	6.75	7.2
	6.13	RC-106*	2.24	13.70	9.75	9.8
	8.00	RC-108	2.24	17.89	11.75	12.0
	10.13	RC-1010*	2.24	22.65	13.75	14.0
	12.00	RC-1012	2.24	26.84	15.75	15.0
	14.00	RC-1014	2.24	31.31	17.75	18.0
15 (15.7)	1.00	RC-151	3.14	3.14	4.88	7.2
	2.00	RC-152	3.14	6.28	5.88	9.0
	4.00	RC-154*	3.14	12.57	7.88	11.0
	6.00	RC-156*	3.14	18.85	10.69	15.0
	8.00	RC-158	3.14	25.13	12.69	18.0
	10.00	RC-1510	3.14	31.42	14.69	21.0
	12.00	RC-1512	3.14	37.70	16.69	24.0
	14.00	RC-1514	3.14	43.98	18.69	26.0
25 (25.8)	1.00	RC-251	5.16	5.16	5.50	13.0
	2.00	RC-252*	5.16	10.31	6.50	14.0
	4.00	RC-254*	5.16	20.63	8.50	18.0
	6.25	RC-256*	5.16	32.23	10.75	22.0
	8.25	RC-258	5.16	42.55	12.75	27.0
	10.25	RC-2510	5.16	52.86	14.75	31.0
	12.25	RC-2512	5.16	63.18	16.75	36.0
	14.25	RC-2514*	5.16	73.49	18.75	39.0
30 (32.4)	8.25	RC-308	6.49	53.56	15.25	40.0
50 (55.2)	2.00	RC-502	11.04	22.09	6.94	33.0
	4.00	RC-504	11.04	44.18	8.94	42.0
	6.25	RC-506*	11.04	69.03	11.13	51.0
	13.25	RC-5013	11.04	146.34	18.13	83.0
75 (79.5)	6.13	RC-756	15.90	97.41	11.25	65.0
	13.13	RC-7513	15.90	208.74	19.38	130.0
100 (103.1)	6.63	RC-1006	20.63	136.67	14.06	130.0
	10.25	RC-10010	20.63	211.45	17.69	160.0

\* Available as a set. See note on this page.

\*\* RC-50 cylinder has non-removable grooved saddle and no collar thread.

## RC Series



Capacity:

**5-100 tons**

Stroke:

**.63-14.25 inches**

Maximum Operating Pressure:

**10,000 psi**



### Think Safety

Manufacturer's rating of load and stroke are maximum safe limits.

Good practice encourages using only 80% of these ratings!

Page: 274



### RAC-Series, Single-Acting Cylinders

The lightweight general purpose spring return aluminum cylinders.

Page: 12



### RC-Series DUO Cylinders

maintain external dimensions for use with existing fixtures.



### Gauges

Minimize the risk of overloading and ensure long, dependable service from your equipment. Refer to

the System Components section for a full range of gauges.

Page: 117

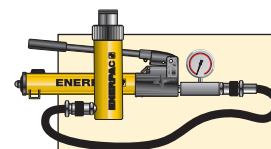

### Pump and Cylinder Sets

All cylinders marked with an \* are available as sets (cylinder, gauge, couplers, hose and pump) for your ordering convenience.

Page: 52

# RC-Series DUO Cylinders, Single-Acting



### Speed Chart

See the Enerpac Cylinder Speed Chart in our "Yellow Pages" to determine your approximate cylinder speed.

Page: **283**

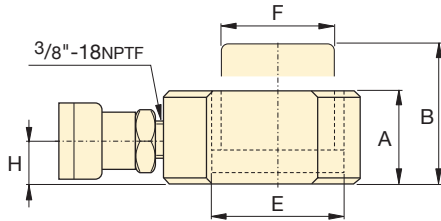
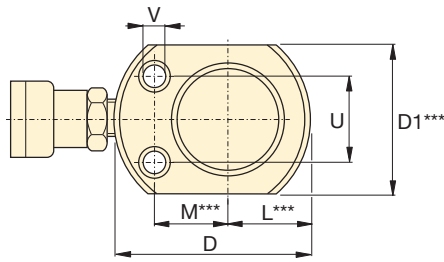

**RC-50**

**RC-101 only**  
(U1 = .75 inch)

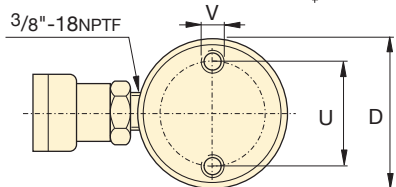
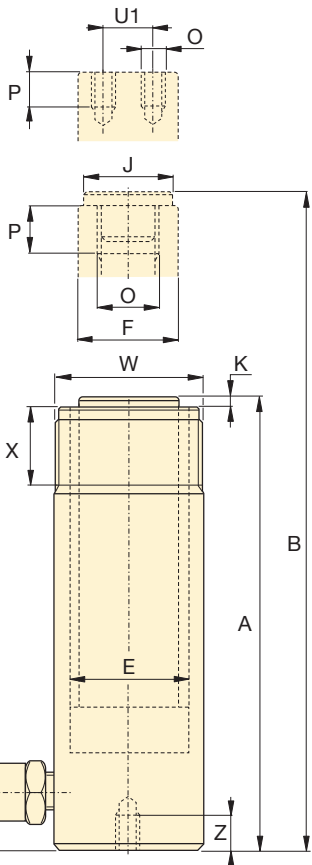

**RC-51 to RC-5013 models**

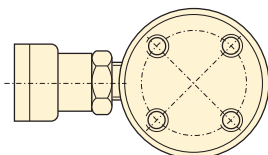

**RC-1006 and RC-10010 models**

◀ For full features see page 6.

Cylinder Capacity	Stroke	Model Number	Cylinder Effective Area	Oil Capacity	Collapsed Height	Extended Height	Outside Diameter
tons (maximum)	(in)		(in <sup>2</sup> )	(in <sup>3</sup> )	A (in)	B (in)	D (in)
<b>5</b> (4.9)	.63	<b>RC-50**</b>	.99	.62	1.63	2.25	2.31
	1.00	<b>RC-51</b>	.99	.99	4.34	5.34	1.50
	3.00	<b>RC-53</b>	.99	2.98	6.50	9.50	1.50
	5.00	<b>RC-55*</b>	.99	4.97	8.50	13.50	1.50
	7.00	<b>RC-57</b>	.99	6.96	10.75	17.75	1.50
9.13	<b>RC-59</b>	.99	9.07	12.75	21.88	1.50	
<b>10</b> (11.2)	1.00	<b>RC-101</b>	2.24	2.24	3.53	4.53	2.25
	2.13	<b>RC-102*</b>	2.24	4.75	4.78	6.91	2.25
	4.13	<b>RC-104</b>	2.24	9.23	6.75	10.88	2.25
	6.13	<b>RC-106*</b>	2.24	13.70	9.75	15.88	2.25
	8.00	<b>RC-108</b>	2.24	17.89	11.75	19.75	2.25
	10.13	<b>RC-1010*</b>	2.24	22.65	13.75	23.88	2.25
	14.00	<b>RC-1014</b>	2.24	31.31	17.75	31.75	2.25
<b>15</b> (15.7)	1.00	<b>RC-151</b>	3.14	3.14	4.88	5.88	2.75
	2.00	<b>RC-152</b>	3.14	6.28	5.88	7.88	2.75
	4.00	<b>RC-154*</b>	3.14	12.57	7.88	11.88	2.75
	6.00	<b>RC-156*</b>	3.14	18.85	10.69	16.69	2.75
	8.00	<b>RC-158</b>	3.14	25.13	12.69	20.69	2.75
	10.00	<b>RC-1510</b>	3.14	31.42	14.69	24.69	2.75
	12.00	<b>RC-1512</b>	3.14	37.70	16.69	28.69	2.75
	14.00	<b>RC-1514</b>	3.14	43.98	18.69	32.69	2.75
<b>25</b> (25.8)	1.00	<b>RC-251</b>	5.16	5.16	5.50	6.50	3.38
	2.00	<b>RC-252*</b>	5.16	10.31	6.50	8.50	3.38
	4.00	<b>RC-254*</b>	5.16	20.63	8.50	12.50	3.38
	6.25	<b>RC-256*</b>	5.16	32.23	10.75	17.00	3.38
	8.25	<b>RC-258</b>	5.16	42.55	12.75	21.00	3.38
	10.25	<b>RC-2510</b>	5.16	52.86	14.75	25.00	3.38
	12.25	<b>RC-2512</b>	5.16	63.18	16.75	29.00	3.38
14.25	<b>RC-2514*</b>	5.16	73.49	18.75	33.00	3.38	
<b>30</b> (32.4)	8.25	<b>RC-308</b>	6.51	53.56	15.25	23.50	4.00
<b>50</b> (55.2)	2.00	<b>RC-502</b>	11.04	22.09	6.94	8.94	5.00
	4.00	<b>RC-504</b>	11.04	44.18	8.94	12.94	5.00
	6.25	<b>RC-506*</b>	11.04	69.03	11.13	17.38	5.00
	13.25	<b>RC-5013</b>	11.04	146.34	18.13	31.38	5.00
<b>75</b> (79.5)	6.13	<b>RC-756</b>	15.90	97.41	11.25	17.38	5.75
	13.13	<b>RC-7513</b>	15.90	208.74	19.38	32.50	5.75
<b>100</b> (103.1)	6.63	<b>RC-1006</b>	20.63	136.67	14.06	20.69	7.00
	10.25	<b>RC-10010</b>	20.63	211.45	17.69	27.94	7.00

\* Available as a set. See page 52.

\*\* RC-50 cylinder has non-removable grooved saddle and no collar thread.

\*\*\* D1 = 1.63 inch, L = .81 inch, M = 1.00 inch.

# Single-Acting, General Purpose Cylinders

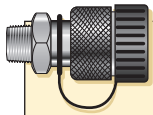

**Couplers Included!**  
CR-400 couplers included on all models. Fits all HC-Series hoses.

Capacity:  
**5-100 tons**

Stroke:  
**.63-14.25 inches**





Maximum Operating Pressure:  
**10,000 psi**

**RC Series**

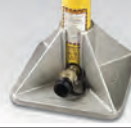

Cylinder Bore Diam.	Plunger Diam.	Base to Adv. Port	Saddle Diam.	Saddle Protrusion from Plngr.	Plunger Internal Thread	Plunger Thread Length	Base Mounting Holes			Collar Thread	Collar Thread Length	Weight (lbs)	Model Number
							Bolt Circle U (in)	Thread V (in)	Thread Depth Z (in)				
E (in)	F (in)	H (in)	J (in)	K (in)	O (in)	P (in)	U (in)	V (in)	Z (in)	W (in)	X (in)		
1.13	1.00	.75	**	**	**	**	1.13	.22	—	—	—	2.2	RC-50**
1.13	1.00	.75	1.00	.25	3/4"-16	.56	1.00	1/4"-20UN	.56	1 1/2"-16	1.13	2.3	RC-51
1.13	1.00	.75	1.00	.25	3/4"-16	.56	1.00	1/4"-20UN	.56	1 1/2"-16	1.13	3.3	RC-53
1.13	1.00	.75	1.00	.25	3/4"-16	.56	1.00	1/4"-20UN	.56	1 1/2"-16	1.13	4.1	RC-55*
1.13	1.00	.75	1.00	.25	3/4"-16	.63	1.00	1/4"-20UN	.56	1 1/2"-16	1.13	5.3	RC-57
1.13	1.00	.75	1.00	.25	3/4"-16	.63	1.00	1/4"-20UN	.56	1 1/2"-16	1.13	6.1	RC-59
1.69	1.50	.75	—	—	#10-24UN	.25	1.56	5/16"-18UN	.50	2 1/4"-14	1.06	4.0	RC-101
1.69	1.50	.75	1.38	.25	1"-8	.75	1.56	5/16"-18UN	.50	2 1/4"-14	1.13	5.1	RC-102*
1.69	1.50	.75	1.38	.25	1"-8	.75	1.56	5/16"-18UN	.50	2 1/4"-14	1.06	7.2	RC-104
1.69	1.50	.75	1.38	.25	1"-8	.75	1.56	5/16"-18UN	.50	2 1/4"-14	1.13	9.8	RC-106*
1.69	1.50	.75	1.38	.25	1"-8	.75	1.56	5/16"-18UN	.50	2 1/4"-14	1.06	12	RC-108
1.69	1.50	.75	1.38	.25	1"-8	.75	1.56	5/16"-18UN	.50	2 1/4"-14	1.13	14	RC-1010*
1.69	1.50	.75	1.38	.25	1"-8	.75	1.56	5/16"-18UN	.50	2 1/4"-14	1.06	15	RC-1012
1.69	1.50	.75	1.38	.25	1"-8	.75	1.56	5/16"-18UN	.50	2 1/4"-14	1.06	18	RC-1014
2.00	1.63	.75	1.50	.38	1"-8	1.00	1.88	3/8"-16UN	.50	2 3/4"-16	1.19	7.2	RC-151
2.00	1.63	.75	1.50	.38	1"-8	1.00	1.88	3/8"-16UN	.50	2 3/4"-16	1.19	9	RC-152
2.00	1.63	.75	1.50	.38	1"-8	1.00	1.88	3/8"-16UN	.50	2 3/4"-16	1.19	11	RC-154*
2.00	1.63	1.00	1.50	.38	1"-8	1.00	1.88	3/8"-16UN	.50	2 3/4"-16	1.19	15	RC-156*
2.00	1.63	1.00	1.50	.38	1"-8	1.00	1.88	3/8"-16UN	.50	2 3/4"-16	1.19	18	RC-158
2.00	1.63	1.00	1.50	.38	1"-8	1.00	1.88	3/8"-16UN	.50	2 3/4"-16	1.19	21	RC-1510
2.00	1.63	1.00	1.50	.38	1"-8	1.00	1.88	3/8"-16UN	.50	2 3/4"-16	1.19	24	RC-1512
2.00	1.63	1.00	1.50	.38	1"-8	1.00	1.88	3/8"-16UN	.50	2 3/4"-16	1.19	26	RC-1514
2.56	2.25	1.00	2.00	.41	1 1/2"-16	1.00	2.31	1/2"-13UN	.75	3-12	1.94	13	RC-251
2.56	2.25	1.00	2.00	.41	1 1/2"-16	1.00	2.31	1/2"-13UN	.75	3 5/16"-12	1.94	14	RC-252*
2.56	2.25	1.00	2.00	.41	1 1/2"-16	1.00	2.31	1/2"-13UN	.75	3 5/16"-12	1.94	18	RC-254*
2.56	2.25	1.00	2.00	.41	1 1/2"-16	1.00	2.31	1/2"-13UN	.75	3 5/16"-12	1.94	22	RC-256*
2.56	2.25	1.00	2.00	.41	1 1/2"-16	1.00	2.31	1/2"-13UN	.75	3 5/16"-12	1.94	27	RC-258
2.56	2.25	1.00	2.00	.41	1 1/2"-16	1.00	2.31	1/2"-13UN	.75	3 5/16"-12	1.94	31	RC-2510
2.56	2.25	1.00	2.00	.41	1 1/2"-16	1.00	2.31	1/2"-13UN	.75	3 5/16"-12	1.94	36	RC-2512
2.56	2.25	1.00	2.00	.41	1 1/2"-16	1.00	2.31	1/2"-13UN	.75	3 5/16"-12	1.94	39	RC-2514*
2.88	2.25	2.25	2.00	.41	1 1/2"-16	1.00	—	—	—	3 5/16"-12	1.94	40	RC-308
3.75	3.13	1.31	2.81	.11	—	—	3.75	1/2"-13UN	.75	5"-12	2.19	33	RC-502
3.75	3.13	1.31	2.81	.11	—	—	3.75	1/2"-13UN	.75	5"-12	2.19	42	RC-504
3.75	3.13	1.38	2.81	.11	—	—	3.75	1/2"-13UN	.75	5"-12	2.19	51	RC-506*
3.75	3.13	1.38	2.81	.11	—	—	3.75	1/2"-13UN	.75	5"-12	2.19	83	RC-5013
4.50	3.75	1.19	2.81	.23	—	—	—	—	—	5 3/4"-12	1.75	65	RC-756
4.50	3.75	1.19	2.81	.23	—	—	—	—	—	5 3/4"-12	1.75	130	RC-7513
5.13	4.13	1.63	2.81	.11	—	—	5.50	3/4"-10UN	1.00	6 7/8"-12	1.75	130	RC-1006
5.13	4.13	1.63	2.81	.11	—	—	5.50	3/4"-10UN	1.00	6 7/8"-12	1.75	160	RC-10010

## ▼ SELECTION CHART

For Use with Cylinder Capacity (tons)	Saddles			Base Plate	Mounting Block	Clevis Eyes	
	Flat	Grooved <sup>1)</sup>	Tilt			Base <sup>4)</sup>	Plunger
							
5	A-53F <sup>2)</sup>	A-53G <sup>2)</sup>	-	-	RB-5 <sup>2)</sup> , AW-51 <sup>2)</sup> , AW-53 <sup>2)</sup>	REB-5 <sup>2)</sup>	REP-5 <sup>2)</sup>
10	A-12 <sup>3)</sup> , A-102F <sup>3)</sup>	A-102G <sup>3)</sup>	CAT-10 <sup>3)</sup>	JBI-10	RB-10, AW-102	REB-10	REP-10 <sup>3)</sup>
15	-	A-152G	CAT-10	-	RB-15	REB-15	REP-10
25	A-29	A-252G	CAT-50	JBI-25	RB-25	REB-25	REP-25
30	A-29	A-252G	CAT-50	-	RB-25	-	REP-25
50	-	-	CAT-100	JBI-50	-	-	-
75	-	-	CAT-100	-	-	-	-
100	-	-	CAT-100	-	-	-	-

<sup>1)</sup> Standard on 5-30 ton RC-cylinders   <sup>2)</sup> Except RC-50   <sup>3)</sup> Except RC-101   <sup>4)</sup> Mounting screws are included.

## ▼ DIMENSION CHARTS

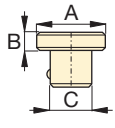
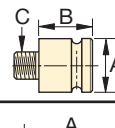
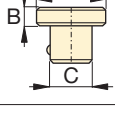
Model Number	Saddle Dimensions (in)			
	A	B	C	
<b>Flat</b>				
A-53F	1.00	.25	.68	
A-102F	1.38	.24	.88	
A-12	2.00	1.88	1" - 8UNC	
A-29	2.00	1.88	1 1/2" - 16UN	
<b>Grooved</b>				
A-53G	1.00	.25	.68	
A-102G	1.38	.24	.88	
A-152G	1.50	.37	.88	
A-252G	1.97	.37	1.40	

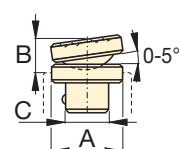
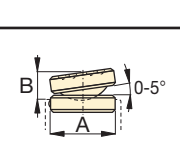
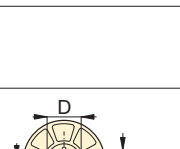
Model Number	Tilt Saddle Dimensions (in)			
	A	B	C	
<b>Tilt</b>				
CAT-10	1.38	.79	.88	
CAT-50	1.97	.83	1.40	
<b>Tilt</b>				
CAT-100	2.80	.98	-	

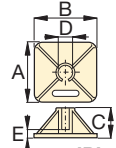
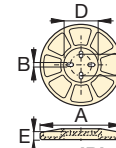
Model Number	Base Plate Dimensions (in)						
	A	B	C	D	E		
JBI-10	9.00	9.00	5.34	2.29	.81	JBI-10, -25	JBI-50
JBI-25	11.00	11.00	5.53	3.41	1.03		
JBI-50	12.00	.60	3.75	5.19	1.25		

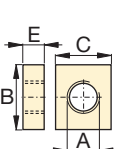
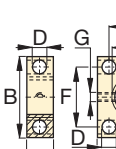
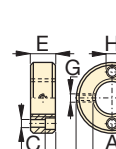
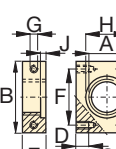
Model Number	Mounting Block Dimensions (in)											
	A	B	C	D	E	F	G	H				
RB-5	1 1/2" - 16	3.50	3.00	-	1.00	-	-	-	RB-5, -10 RB-15, -25	AW-51	AW-53	AW-102 (J=.19)
AW-51	1 1/2" - 16	2.76	2.36	.43	.98	2.13	1/4" - 20	1.62				
AW-53	1 1/2" - 16	2.87	.28	.31	.75	2.25	1/4" - 20	.41				
RB-10	2 1/4" - 14	4.50	3.50	-	1.00	-	-	-				
AW-102	2 1/4" - 14	3.94	3.25	.63	1.18	3.00	7/16" - 20	2.31				
RB-15	2 3/4" - 16	4.00	4.50	-	1.50	-	-	-				
RB-25	3 5/16" - 12	5.00	6.50	-	2.00	-	-	-				

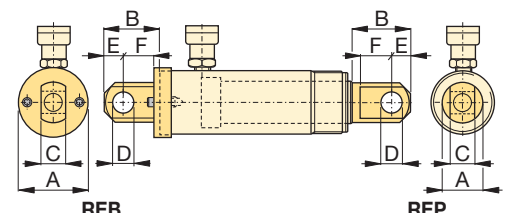
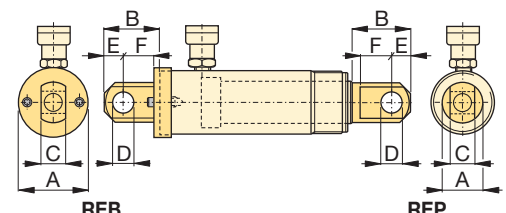
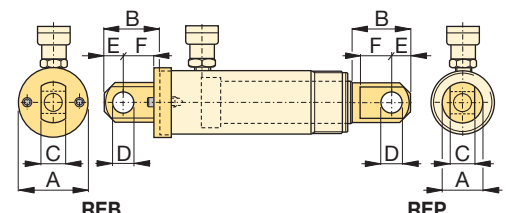
Type	Model Number	Clevis Eye Dimensions (in)						Pin to Pin* (in)	
		A	B	C	D	E	F		
Base <sup>4)</sup>	REB-5	1.75	1.88	.56	.63	.63	1.00	2.37	
	REB-10	2.50	2.63	1.00	.88	1.00	1.38	3.07	
	REB-15	3.00	2.63	1.00	.88	1.00	1.38	3.07	
	REB-25	3.75	3.13	1.50	1.25	1.25	1.63	3.45	
Plunger	REP-5	1.13	1.75	.56	.63	.63	.75	-	
	REP-10	1.69	2.43	1.00	.88	1.00	1.13	-	
	REP-25	2.25	2.81	1.50	1.25	1.25	1.38	-	

\* Pin to Pin- REB and REP Clevises fitted. Add cylinder collapsed height.

<sup>4)</sup> Mounting screws are included.

# The Enerpac Lightweight Aluminum Cylinders

▼ Shown: RAC, RACL, RACH, and RAR



- Lightweight, easy to carry and position to allow a higher cylinder capacity-to-weight-ratio
- Non-corrosive by design, aluminum has always been a good material for use in many caustic environments
- Composite bearings on all moving surfaces guarantee NO metal-to-metal contact, to resist side loads and increase cylinder life

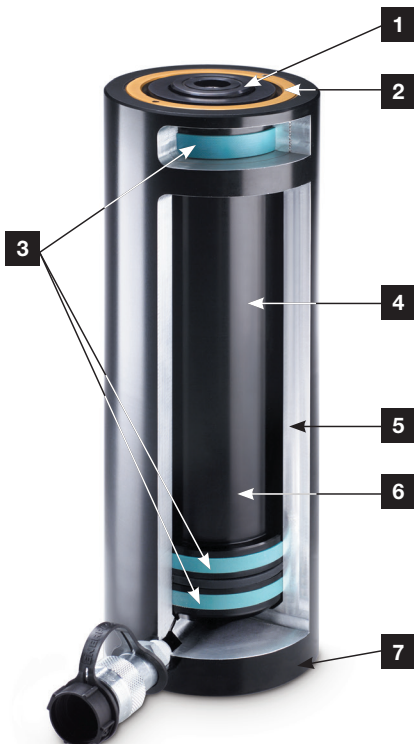

1. **Removable Hardened Saddle** protects plunger from being damaged by abrasive surface contact.
2. **Stop Ring** on all models absorbs eccentric loading and prevents plunger over-extension.
3. **Composite Bearing** material to prevent metal-to-metal contact, reducing side-load issues and increasing life.
4. **Hard-coated Plunger and Base** resist wear and prevent galling.
5. **7075-T6 Aluminum Alloy Components** for maximum strength and minimum weight.
6. **Plunger Return Spring** on all single-acting models for prompt cylinder return.
7. **Steel Base Plate** protects cylinder base from abrasive surfaces.

## RA Series

Capacity:

**10-150 tons**

Stroke:

**1.97-9.84 inches**

Maximum Operating Pressure:

**10,000 psi**



Think Safety

Manufacturer's rating of load and stroke are maximum safe limits.

Good practice encourages using only 80% of these ratings!

Page: 274



### Aluminum vs. Steel

Aluminum cylinders, while offering the most lightweight solution also have some unique limitations due to material properties. It differs from steel in that it has a lower finite fatigue life. Aluminum cylinders should NOT be used in high-cycle applications such as production.

These cylinders are designed to provide 5000 cycles at their recommended pressure. **This limit should not be exceeded.** In normal lifting and many maintenance applications, this should provide a lifetime of use.



▼ Shown from left to right: RAC-508, RAC-1506, RAC-304, and RAC-206



## Lightweight for Maximum Portability



### Saddles

All RAC cylinders are equipped with bolt-on removable saddles of hardened steel.



### Lightweight Hand Pumps

Enerpac hand pumps **P-392** or **P-802** make the optimal lightweight set.

Page: **70**

- Composite bearings prevent metal-to-metal contact, increasing cylinder life and resistance to side-loads of up to 10%
- Hard coat finish on all surfaces resists damage and extends cylinder life
- Handles included on all models 30 tons and above
- For protection against load-induced damage, a saddle is standard on all models and a steel baseplate is standard on models 20-ton and above. The steel baseplate is optional only on 10- and 15-ton models
- Integral stop ring prevents plunger over-travel and is capable of withstanding the full cylinder capacity
- High-strength return spring for rapid cylinder retraction
- CR-400 coupler and dust cap included on all models
- All cylinders meet ASME B-30.1 standards

Cylinder Capacity	Stroke*	Model Number	Cylinder Effective Area
tons (maximum)	(in)		(in <sup>2</sup> )
<b>10</b> (9.9)	1.97	<b>RAC-102</b>	1.95
	3.94	<b>RAC-104</b>	1.95
	5.91	<b>RAC-106</b>	1.95
<b>15</b> (15.4)	1.97	<b>RAC-152</b>	3.03
	3.94	<b>RAC-154</b>	3.03
	5.91	<b>RAC-156</b>	3.03
<b>20</b> (24.2)	1.97	<b>RAC-202</b>	4.83
	3.94	<b>RAC-204</b>	4.83
	5.91	<b>RAC-206</b>	4.83
	7.87	<b>RAC-208</b>	4.83
	9.84	<b>RAC-2010</b>	4.83
<b>30</b> (34.2)	1.97	<b>RAC-302</b>	6.85
	3.94	<b>RAC-304</b>	6.85
	5.91	<b>RAC-306</b>	6.85
	7.87	<b>RAC-308</b>	6.85
	9.84	<b>RAC-3010</b>	6.85
<b>50</b> (54.9)	1.97	<b>RAC-502</b>	10.99
	3.94	<b>RAC-504</b>	10.99
	5.91	<b>RAC-506</b>	10.99
	7.87	<b>RAC-508</b>	10.99
	9.84	<b>RAC-5010</b>	10.99
<b>100</b> (110.9)	1.97	<b>RAC-1002</b>	22.19
	3.94	<b>RAC-1004</b>	22.19
	5.91	<b>RAC-1006</b>	22.19
	7.87	<b>RAC-1008</b>	22.19
	9.84	<b>RAC-10010</b>	22.19
<b>150</b> (175.9)	1.97	<b>RAC-1502</b>	35.18
	3.94	<b>RAC-1504</b>	35.18
	5.91	<b>RAC-1506</b>	35.18
	7.87	<b>RAC-1508</b>	35.18
	9.84	<b>RAC-15010</b>	35.18

\* Custom strokes available.



◀ Enerpac lightweight aluminum RAC-506 cylinders are ideal for wet environments such as this tunnel under the river (Holland High-Speed Train Line).

# Single-Acting, Spring Return Cylinders



## Steel Base Plate

The steel base plate protects the cylinder base from damage, it should not be removed.

The base holes in these aluminum cylinders are designed for securing the steel base plate. **They will not withstand the capacity of the cylinder.**

Do not use the base holes in these aluminum cylinders to attach any device to the cylinder.

Capacity:  
**10-150 tons**

Stroke:  
**1.97-9.84 inches**

Maximum Operating Pressure:  
**10,000 psi**

## RAC Series



### Optional Bolt-on Tilt Saddle Dimensions (in)

Cylinder Model / Capacity (ton)	Model Number*	Saddle Diameter J1	Saddle Protrusion from Plunger K1
RAC-50	CATG-50	1.95	1.02
RAC-100	CATG-150	3.57	1.30
RAC-150	CATG-200	4.64	1.44

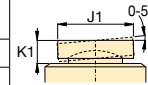

\* Tilt saddle not available for less than 50 ton.

### Optional Steel Base Plate

Cylinder Model / Capacity (ton)	Model Number
RAC-10	JBA10
RAC-15	JBA15

\* Steel base plates come standard on models 20 tons and above.

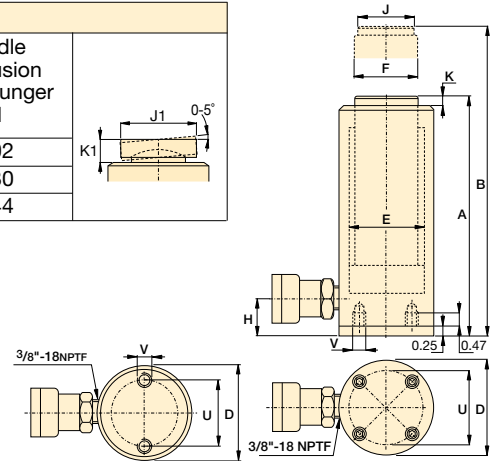

RAC-102 to RAC-156 RAC-202 to RAC-15010

Oil Capacity (in <sup>3</sup> )	Collapsed Height A (in)	Extended Height B (in)	Outside Diameter D (in)	Cylinder Bore Diameter E (in)	Plunger Diameter F (in)	Base to Advance Port H (in)	Saddle Diameter J (in)	Saddle Protrusion from Plunger K (in)	Bolt Circle U (in)	Thread V (mm)	Weight (lbs)	Model Number
3.66	6.06	7.91	2.28	1.57	1.26	0.91	0.94	0.12	1.54	M6	2.6	RAC-102
7.93	8.03	11.97	2.28	1.57	1.26	0.91	0.94	0.12	1.54	M6	3.1	RAC-104
11.59	10.00	15.91	2.28	1.57	1.26	0.91	0.94	0.12	1.54	M6	4.0	RAC-106
6.10	6.34	8.31	2.76	1.97	1.57	0.91	1.14	0.12	1.89	M6	4.0	RAC-152
12.20	8.31	12.24	2.76	1.97	1.57	0.91	1.14	0.12	1.89	M6	4.2	RAC-154
17.69	10.28	16.18	2.76	1.97	1.57	0.91	1.14	0.12	1.89	M6	6.6	RAC-156
9.52	6.85	8.83	3.35	2.48	1.97	1.07	1.58	0.12	2.76	M6	7.9	RAC-202
19.03	8.82	12.76	3.35	2.48	1.97	1.07	1.58	0.12	2.76	M6	9.0	RAC-204
28.55	10.79	16.70	3.35	2.48	1.97	1.07	1.58	0.12	2.76	M6	10.1	RAC-206
38.01	12.76	20.64	3.35	2.48	1.97	1.07	1.58	0.12	2.76	M6	11.2	RAC-208
47.53	14.73	24.58	3.35	2.48	1.97	1.07	1.58	0.12	2.76	M6	12.3	RAC-2010
13.49	7.13	9.10	3.94	2.95	2.36	1.31	1.58	0.12	3.15	M6	9.9	RAC-302
26.99	9.09	13.04	3.94	2.95	2.36	1.31	1.58	0.12	3.15	M6	11.5	RAC-304
40.48	11.06	16.98	3.94	2.95	2.36	1.31	1.58	0.12	3.15	M6	13.0	RAC-306
53.91	13.04	20.91	3.94	2.95	2.36	1.31	1.58	0.12	3.15	M6	14.5	RAC-308
67.40	15.01	24.85	3.94	2.95	2.36	1.31	1.58	0.12	3.15	M6	16.1	RAC-3010
21.65	7.32	9.90	5.12	3.74	3.15	1.19	1.97	0.12	4.33	M6	18.7	RAC-502
43.30	9.29	13.24	5.12	3.74	3.15	1.19	1.97	0.12	4.33	M6	21.6	RAC-504
64.95	11.26	17.17	5.12	3.74	3.15	1.19	1.97	0.12	4.33	M6	24.5	RAC-506
86.49	13.24	21.11	5.12	3.74	3.15	1.19	1.97	0.12	4.33	M6	27.3	RAC-508
108.14	15.21	25.05	5.12	3.74	3.15	1.19	1.97	0.12	4.33	M6	30.2	RAC-5010
43.71	8.71	10.68	7.09	5.32	4.33	1.82	3.70	0.12	5.91	M10	38.1	RAC-1002
87.43	10.67	14.61	7.09	5.32	4.33	1.82	3.70	0.12	5.91	M10	43.2	RAC-1004
131.14	12.64	18.55	7.09	5.32	4.33	1.82	3.70	0.12	5.91	M10	48.3	RAC-1006
174.64	14.61	22.49	7.09	5.32	4.33	1.82	3.70	0.12	5.91	M10	53.4	RAC-1008
218.35	16.58	26.43	7.09	5.32	4.33	1.82	3.70	0.12	5.91	M10	58.4	RAC-10010
69.30	9.56	11.53	9.06	6.69	5.51	2.02	4.45	0.12	7.87	M10	55.8	RAC-1502
138.61	11.53	15.47	9.06	6.69	5.51	2.02	4.45	0.12	7.87	M10	64.6	RAC-1504
207.91	13.49	19.41	9.06	6.69	5.51	2.02	4.45	0.12	7.87	M10	73.4	RAC-1506
276.87	15.47	23.34	9.06	6.69	5.51	2.02	4.45	0.12	7.87	M10	82.2	RAC-1508
346.17	17.44	27.28	9.06	6.69	5.51	2.02	4.45	0.12	7.87	M10	91.1	RAC-15010

▼ Shown from left to right: RACL-1006, RACL-504 and RACL-506



## To Secure Loads Mechanically



### Saddles

All RACL cylinders are equipped with bolt-on removable saddles of hardened steel. For tilt saddles see next page.

Page: 15



### Hoses

Enerpac offers a complete line of high-quality hydraulic hoses. To ensure the integrity of your system, specify only Enerpac hydraulic hoses.

Page: 132

- Aluminum Lock Nut provides mechanical load holding for extended periods
- Hardened steel stop ring increases cylinder life and resistance to side-loads of up to 5%
- Hard coat finish on all surfaces resists damage and extends cylinder life
- Composite bearings increase cylinder life and side load resistance
- Handles included on all models
- Steel base plate and saddle for protection against load-induced damage
- Integral stop ring prevents plunger over-travel and is capable of withstanding the full cylinder capacity
- High-strength return spring for rapid cylinder retraction
- CR-400 coupler and dust cap included on all models
- All cylinders meet ASME B-30.1 and ISO 10100 standards



◀ The portable Lock Nut cylinder RACL-1506 used for extended load support during epoxy injection for bridge reinforcement.

Cylinder Capacity	Stroke*	Model Number	Cylinder Effective Area
ton (maximum)	(in)		(in <sup>2</sup> )
20 (24.2)	1.97	RACL-202	4.83
	3.94	RACL-204	4.83
	5.91	RACL-206	4.83
	7.87	RACL-208	4.83
	9.84	RACL-2010	4.83
30 (34.2)	1.97	RACL-302	6.85
	3.94	RACL-304	6.85
	5.91	RACL-306	6.85
	7.87	RACL-308	6.85
	9.84	RACL-3010	6.85
50 (54.9)	1.97	RACL-502	10.99
	3.94	RACL-504	10.99
	5.91	RACL-506	10.99
	7.87	RACL-508	10.99
	9.84	RACL-5010	10.99
100 (110.9)	1.97	RACL-1002	22.19
	3.94	RACL-1004	22.19
	5.91	RACL-1006	22.19
	7.87	RACL-1008	22.19
	9.84	RACL-10010	22.19
150 (175.9)	1.97	RACL-1502	35.18
	3.94	RACL-1504	35.18
	5.91	RACL-1506	35.18
	7.87	RACL-1508	35.18
	9.84	RACL-15010	35.18

\* Custom strokes available.

# Single-Acting, Spring Return, Lock Nut Cylinders



## Steel Base Plate

The steel base plate protects the cylinder base from damage, it should not be removed.

The base holes in these aluminum cylinders are designed for securing the steel base plate. **They will not withstand the capacity of the cylinder.**

Do not use the base holes in these aluminum cylinders to attach any device to the cylinder.

Capacity:  
**20-150 tons**

Stroke:  
**1.97-9.84 inches**

Maximum Operating Pressure:  
**10,000 psi**

## RACL Series



### Optional Bolt-on Tilt Saddle Dimensions (in)

Cylinder Model / Capacity (ton)	Model Number*	Saddle Diameter	Saddle Protrusion from Plunger K1
		J1	
RACL-50	CATG-50	1.95	1.02
RACL-100	CATG-150	3.57	1.30
RACL-150	CATG-200	4.64	1.44

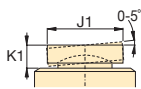

\* Tilt saddle not available for less than 50 ton.

### Steel Base Plate Mounting Holes

Cylinder Model / Capacity (ton)	Bolt Circle U (in)	Thread V (mm)	Thread Depth <sup>1)</sup> Z (in)
RACL-20	2.76	M6	.47
RACL-30	3.15	M6	.47
RACL-50	4.33	M6	.47
RACL-100	5.91	M10	.47
RACL-150	7.87	M10	.47

<sup>1)</sup> Including Base Plate Height of .25 inches. Four (4) base plate bolts included.

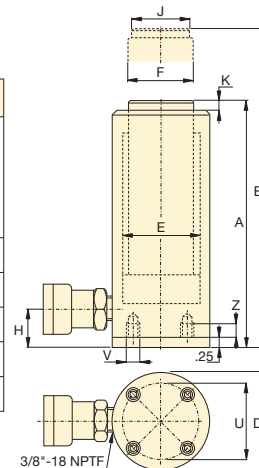

Oil Capacity (in <sup>3</sup> )	Collapsed Height A (in)	Extended Height B (in)	Outside Diameter D (in)	Cylinder Bore Diameter E (in)	Plunger Diameter (Threaded) F (in)	Base to Advance Port H (in)	Saddle Diameter J (in)	Saddle Protrusion from Plunger K (in)	Lock Nut Height S (in)	Weight (lbs)	Model Number
9.52	8.83	10.80	3.35	2.48	2.17	1.07	1.58	0.12	1.97	8.8	RACL-202
19.03	10.80	14.73	3.35	2.48	2.17	1.07	1.58	0.12	1.97	10.1	RACL-204
28.55	12.76	18.67	3.35	2.48	2.17	1.07	1.58	0.12	1.97	11.4	RACL-206
38.01	14.73	22.61	3.35	2.48	2.17	1.07	1.58	0.12	1.97	12.7	RACL-208
47.53	16.70	26.54	3.35	2.48	2.17	1.07	1.58	0.12	1.97	14.1	RACL-2010
13.49	9.10	11.07	3.94	2.95	2.36	1.31	1.58	0.12	1.97	11.9	RACL-302
26.99	11.07	15.01	3.94	2.95	2.36	1.31	1.58	0.12	1.97	13.4	RACL-304
40.48	13.04	18.95	3.94	2.95	2.36	1.31	1.58	0.12	1.97	14.9	RACL-306
53.91	15.01	22.88	3.94	2.95	2.36	1.31	1.58	0.12	1.97	16.5	RACL-308
67.40	16.98	26.82	3.94	2.95	2.36	1.31	1.58	0.12	1.97	18.0	RACL-3010
21.65	9.29	11.27	5.12	3.74	3.15	1.19	1.97	0.12	2.95	20.5	RACL-502
43.30	11.26	15.21	5.12	3.74	3.15	1.19	1.97	0.12	2.95	23.4	RACL-504
64.95	13.23	19.14	5.12	3.74	3.15	1.19	1.97	0.12	2.95	26.2	RACL-506
86.49	15.20	23.08	5.12	3.74	3.15	1.19	1.97	0.12	2.95	29.1	RACL-508
108.14	17.17	27.02	5.12	3.74	3.15	1.19	1.97	0.12	2.95	31.9	RACL-5010
43.71	11.65	13.63	7.09	5.32	4.33	1.82	3.70	0.12	2.95	48.2	RACL-1002
87.43	13.62	17.57	7.09	5.32	4.33	1.82	3.70	0.12	2.95	53.3	RACL-1004
131.14	15.59	21.50	7.09	5.32	4.33	1.82	3.70	0.12	2.95	58.4	RACL-1006
174.64	17.57	25.44	7.09	5.32	4.33	1.82	3.70	0.12	2.95	63.4	RACL-1008
218.35	19.54	29.38	7.09	5.32	4.33	1.82	3.70	0.12	2.95	68.5	RACL-10010
69.30	12.72	14.68	9.06	6.69	5.51	2.02	4.45	0.12	3.15	71.0	RACL-1502
138.61	14.69	18.62	9.06	6.69	5.51	2.02	4.45	0.12	3.15	79.8	RACL-1504
207.91	16.65	22.56	9.06	6.69	5.51	2.02	4.45	0.12	3.15	88.6	RACL-1506
276.87	18.62	26.49	9.06	6.69	5.51	2.02	4.45	0.12	3.15	97.4	RACL-1508
346.17	20.59	30.43	9.06	6.69	5.51	2.02	4.45	0.12	3.15	106.3	RACL-15010

▼ Shown from left to right: RACH-1508, RACH-304 and RACH-208



## The Lightweight Solution for Tensioning and Testing



### Saddles

All RACH-cylinders are equipped with bolt-on removable hardened steel hollow saddles.



### Lightweight Hand Pumps

Enerpac hand pumps **P-392** or **P-802** make the optimal lightweight set.

Page: 70

- Hollow plunger design allows for both pull and push forces
- Composite bearings increase cylinder life and side load resistance
- Hard coat finish on all surfaces resists damage and extends cylinder life
- Handles included on all models
- Floating center tube increases seal life
- Steel baseplate and saddle for protection against load-induced damage
- Integral stop ring prevents plunger over-travel and is capable of withstanding the full cylinder capacity
- High-strength return spring for rapid cylinder retraction
- CR-400 coupler and dust cap included on all models
- All cylinders meet ASME B-30.1 and ISO 10100 standards

Cylinder Capacity	Stroke*	Model Number	Cylinder Effective Area
tons (maximum)	(in)		(in <sup>2</sup> )
20 (25.4)	1.97	RACH-202	5.07
	3.94	RACH-204	5.07
	5.91	RACH-206	5.07
	7.87	RACH-208	5.07
	9.84	RACH-210	5.07
30 (39.6)	1.97	RACH-302	7.92
	3.94	RACH-304	7.92
	5.91	RACH-306	7.92
	7.87	RACH-308	7.92
	9.84	RACH-3010	7.92
60 (65.6)	1.97	RACH-602	13.13
	3.94	RACH-604	13.13
	5.91	RACH-606	13.13
	7.87	RACH-608	13.13
	9.84	RACH-6010	13.13
100 (127.5)	1.97	RACH-1002	25.51
	3.94	RACH-1004	25.51
	5.91	RACH-1006	25.51
	7.87	RACH-1008	25.51
	9.84	RACH-10010	25.51
150 (175.0)	1.97	RACH-1502	35.00
	3.94	RACH-1504	35.00
	5.91	RACH-1506	35.00
	7.87	RACH-1508	35.00
	9.84	RACH-15010	35.00

\* Custom strokes available.



◀ An RACH-306, powered by a P-392 hand pump, is used to extract corroded carriage pins from refuse collection vehicles.

# Single-Acting, Spring Return, Hollow Plunger Cylinders



## Steel Base Plate

The steel base plate protects the cylinder base from damage, it should not be removed.

The base holes in these aluminum cylinders are designed for securing the steel base plate. **They will not**

**withstand the capacity of the cylinder.**

Do not use the base holes in these aluminum cylinders to attach any device to the cylinder.

## RACH Series

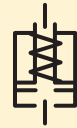

Capacity:

**20-150 tons**

Stroke:

**1.97-9.84 inches**

Center Hole Diameter:

**1.06-3.11 inches**

Maximum Operating Pressure:

**10,000 psi**

### Steel Base Plate Mounting Holes

Cylinder Model / Capacity (ton)	Bolt Circle U (in)	Thread V (mm)	Thread Depth <sup>1)</sup> Z (in)
RACH-20	3.15	M6	.47
RACH-30	4.33	M6	.47
RACH-60	6.30	M6	.47
RACH-100	8.66	M10	.47
RACH-150	9.65	M10	.47

<sup>1)</sup> Including Base Plate Height of .25 inches. Four (4) baseplate bolts included.

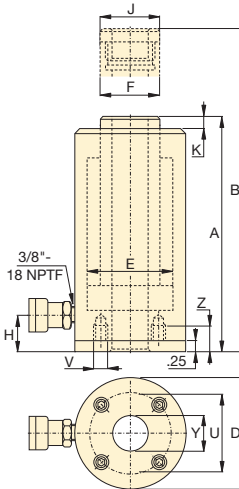

Oil Capacity (in <sup>3</sup> )	Collapsed Height A (in)	Extended Height B (in)	Outside Diameter D (in)	Cylinder Bore Diameter E (in)	Plunger Diameter F (in)	Base to Advance Port H (in)	Saddle Diameter J (in)	Saddle Protrusion from Plunger K (in)	Center Hole Diameter Y (in)	Weight (lbs)	Model Number
9.98	7.41	9.38	3.93	2.95	2.17	1.14	2.17	0.40	1.06	11.5	RACH-202
19.96	9.89	13.83	3.93	2.95	2.17	1.14	2.17	0.40	1.06	13.5	RACH-204
29.94	12.41	18.32	3.93	2.95	2.17	1.14	2.17	0.40	1.06	15.6	RACH-206
39.87	14.89	22.76	3.93	2.95	2.17	1.14	2.17	0.40	1.06	17.7	RACH-208
49.90	17.41	27.25	3.93	2.95	2.17	1.14	2.17	0.40	1.06	19.8	RACH-210
15.59	8.20	10.17	5.12	3.74	2.76	1.14	2.76	0.40	1.34	17.6	RACH-302
31.18	10.52	14.46	5.12	3.74	2.76	1.14	2.76	0.40	1.34	20.9	RACH-304
46.77	13.12	19.02	5.12	3.74	2.76	1.14	2.76	0.40	1.34	24.6	RACH-306
62.35	15.56	23.43	5.12	3.74	2.76	1.14	2.76	0.40	1.34	28.4	RACH-308
77.94	18.04	27.88	5.12	3.74	2.76	1.14	2.76	0.40	1.34	31.9	RACH-3010
25.84	9.89	11.86	7.09	5.12	3.94	2.41	3.94	0.47	2.13	35.6	RACH-602
51.69	12.41	16.35	7.09	5.12	3.94	2.41	3.94	0.47	2.13	42.8	RACH-604
77.53	14.97	20.87	7.09	5.12	3.94	2.41	3.94	0.47	2.13	50.3	RACH-606
103.37	17.52	25.40	7.09	5.12	3.94	2.41	3.94	0.47	2.13	57.2	RACH-608
129.21	20.09	29.93	7.09	5.12	3.94	2.41	3.94	0.47	2.13	65.1	RACH-6010
50.21	10.16	12.13	9.84	7.28	5.71	2.41	5.71	0.55	3.11	74.6	RACH-1002
100.43	12.80	16.74	9.84	7.28	5.71	2.41	5.71	0.55	3.11	87.8	RACH-1004
150.64	15.40	21.31	9.84	7.28	5.71	2.41	5.71	0.55	3.11	101.9	RACH-1006
200.85	18.08	25.95	9.84	7.28	5.71	2.41	5.71	0.55	3.11	115.7	RACH-1008
251.07	20.76	30.60	9.84	7.28	5.71	2.41	5.71	0.55	3.11	129.3	RACH-10010
66.08	11.03	13.00	10.83	8.07	5.91	2.41	5.71	0.55	3.11	107.7	RACH-1502
132.17	14.18	18.12	10.83	8.07	5.91	2.41	5.71	0.55	3.11	122.8	RACH-1504
206.72	16.93	22.84	10.83	8.07	5.91	2.41	5.71	0.55	3.11	138.9	RACH-1506
275.62	19.69	27.57	10.83	8.07	5.91	2.41	5.71	0.55	3.11	154.5	RACH-1508
344.53	22.45	32.29	10.83	8.07	5.91	2.41	5.71	0.55	3.11	170.2	RACH-15010

▼ Shown from left to right: RAR-506, RAR-508, RAR-302



## The Lightweight Solution for Double-Acting Applications



### Saddles

All RAR-cylinders are equipped with bolt-on removable hardened steel saddles. For tilt saddles see next page.

Page: 19



### Hoses

Enerpac offers a complete line of high-quality hydraulic hoses. To ensure the integrity of your system, specify only Enerpac hydraulic hoses.

Page: 132

- Double-acting for rapid retraction, regardless of hose lengths and system losses
- Composite bearings increase cylinder life and side load resistance
- Hard coat finish on all surfaces resists damage and extends cylinder life
- Handles included on all models
- Steel base plate and saddle for protection against load-induced damage
- Integral stop ring prevents plunger over-travel and is capable of withstanding the full cylinder capacity
- Built-in safety valve prevents accidental over-pressurization



◀ An RAR-506 was easy to position under a bulldozer for repair of frame member.

Cylinder Capacity (ton)	Stroke* (in)	Model Number	Maximum Cylinder Capacity (ton)		Cylinder Effective Area (in <sup>2</sup> )		Oil Capacity (in <sup>3</sup> )	
			Push	Pull	Push	Pull	Push	Pull
20 (24.2)	1.97	RAR-202	24.2	14.4	4.83	2.88	9.52	5.67
	3.94	RAR-204	24.2	14.4	4.83	2.88	19.03	11.34
	5.91	RAR-206	24.2	14.4	4.83	2.88	28.55	17.02
	7.87	RAR-208	24.2	14.4	4.83	2.88	38.01	22.66
	9.84	RAR-2010	24.2	14.4	4.83	2.88	47.53	28.34
30 (34.2)	1.97	RAR-302	34.2	19	6.85	3.80	13.49	7.49
	3.94	RAR-304	34.2	19	6.85	3.80	26.99	14.97
	5.91	RAR-306	34.2	19	6.85	3.80	40.48	22.46
	7.87	RAR-308	34.2	19	6.85	3.80	53.91	29.91
	9.84	RAR-3010	34.2	19	6.85	3.80	67.40	37.39
50 (54.9)	1.97	RAR-502	55	21	10.99	3.54	21.65	6.97
	3.94	RAR-504	55	21	10.99	3.54	43.30	13.95
	5.91	RAR-506	55	21	10.99	3.54	64.95	20.92
	7.87	RAR-508	55	21	10.99	3.54	86.49	27.86
	9.84	RAR-5010	55	21	10.99	3.54	108.14	34.83
100 (110.9)	1.97	RAR-1002	111	62	22.19	12.33	43.71	24.29
	3.94	RAR-1004	111	62	22.19	12.33	87.43	48.58
	5.91	RAR-1006	111	62	22.19	12.33	131.14	72.87
	7.87	RAR-1008	111	62	22.19	12.33	174.64	97.04
	9.84	RAR-10010	111	62	22.19	12.33	218.35	121.33
150 (175.9)	1.97	RAR-1502	176	102	35.18	20.45	69.30	40.29
	3.94	RAR-1504	176	102	35.18	20.45	138.61	80.57
	5.91	RAR-1506	176	102	35.18	20.45	207.91	120.86
	7.87	RAR-1508	176	102	35.18	20.45	276.87	160.94
	9.84	RAR-15010	176	102	35.18	20.45	346.17	201.23

\* Custom strokes available.

# Double-Acting, Aluminum Cylinders



## Steel Base Plate

The steel base plate protects the cylinder base from damage, it should not be removed.

The base holes in these aluminum cylinders are designed for securing the steel base plate. **They will not withstand the capacity of the cylinder.**

Do not use the base holes in these aluminum cylinders to attach any device to the cylinder.

Capacity:  
**20-150 tons**

Stroke:  
**1.97-9.84 inches**

Maximum Operating Pressure:  
**10,000 psi**

## RAR Series



### Optional Bolt Tilt Saddle Dimensions (in)

Cylinder Model / Capacity (ton)	Model Number*	Saddle Diameter J1	Saddle Protrusion from Plunger K1
RAR-50	CATG-50	1.95	1.02
RAR-100	CATG-100	2.81	1.22
RAR-150	CATG-150	3.57	1.30

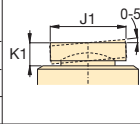

\* Tilt saddle not available for less than 50 ton.

### Steel Base Plate Mounting Holes

Cylinder Model / Capacity (ton)	Bolt Circle U (in)	Thread V (mm)	Thread Depth <sup>1)</sup> Z (in)
RAR-20	3.66	M6	.47
RAR-30	4.13	M6	.47
RAR-50	4.33	M6	.47
RAR-100	6.10	M10	.47
RAR-150	7.87	M10	.47

<sup>1)</sup> Including Base Plate Height of .25 inches. Four (4) base plate bolts included.

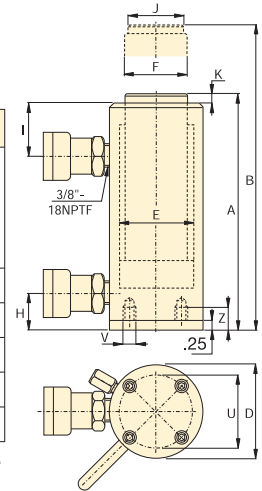

Collapsed Height	Extended Height	Outside Diameter	Cylinder Bore Diameter	Plunger Diameter	Base to Advance Port	Top to Retract Port	Saddle Diameter	Saddle Protrusion from Plunger	Weight	Model Number
A (in)	B (in)	D (in)	E (in)	F (in)	H (in)	I (in)	J (in)	K (in)	(lbs)	
7.45	9.42	4.45	2.48	1.58	1.19	1.97	1.18	0.12	16.3	RAR-202
9.42	13.35	4.45	2.48	1.58	1.19	1.97	1.18	0.12	17.6	RAR-204
11.29	17.29	4.45	2.48	1.58	1.19	1.97	1.18	0.12	19.0	RAR-206
13.35	21.23	4.45	2.48	1.58	1.19	1.97	1.18	0.12	20.3	RAR-208
15.32	25.17	4.45	2.48	1.58	1.19	1.97	1.18	0.12	21.6	RAR-2010
7.92	9.89	4.92	2.95	1.97	1.19	2.17	1.58	0.12	19.0	RAR-302
9.89	13.83	4.92	2.95	1.97	1.19	2.17	1.58	0.12	20.9	RAR-304
11.86	17.76	4.92	2.95	1.97	1.19	2.17	1.58	0.12	22.9	RAR-306
13.83	21.70	4.92	2.95	1.97	1.19	2.17	1.58	0.12	24.9	RAR-308
15.80	25.64	4.92	2.95	1.97	1.19	2.17	1.58	0.12	26.9	RAR-3010
7.92	9.89	5.71	3.74	2.95	1.19	2.21	1.97	0.12	24.5	RAR-502
9.89	13.83	5.71	3.74	2.95	1.19	2.21	1.97	0.12	28.0	RAR-504
11.86	17.76	5.71	3.74	2.95	1.19	2.21	1.97	0.12	31.5	RAR-506
13.83	21.70	5.71	3.74	2.95	1.19	2.21	1.97	0.12	35.1	RAR-508
15.80	25.64	5.71	3.74	2.95	1.19	2.21	1.97	0.12	38.6	RAR-5010
9.89	11.86	7.28	5.32	3.54	1.70	3.15	2.95	0.12	36.2	RAR-1002
11.86	15.80	7.28	5.32	3.54	1.70	3.15	2.95	0.12	42.6	RAR-1004
13.83	19.73	7.28	5.32	3.54	1.70	3.15	2.95	0.12	48.9	RAR-1006
15.80	23.67	7.28	5.32	3.54	1.70	3.15	2.95	0.12	55.3	RAR-1008
17.76	27.61	7.28	5.32	3.54	1.70	3.15	2.95	0.12	61.7	RAR-10010
9.77	11.74	9.06	6.70	4.33	1.50	2.95	3.70	0.12	53.4	RAR-1502
11.74	16.68	9.06	6.70	4.33	1.50	2.95	3.70	0.12	63.7	RAR-1504
13.71	19.61	9.06	6.70	4.33	1.50	2.95	3.70	0.12	73.2	RAR-1506
15.68	23.55	9.06	6.70	4.33	1.50	2.95	3.70	0.12	83.6	RAR-1508
19.61	29.46	9.06	6.70	4.33	1.50	2.95	3.70	0.12	93.9	RAR-15010



▼ LPL-Series, Low-height Lock Nut Cylinders



- Lock nut provides mechanical load holding for a safe work environment
- Integrated tilt saddle allows for up to 5 degrees of misalignment
- Extreme low-height for use in confined areas
- Side-load resistance 5-10% of maximum capacity
- Overflow port as stroke limiter to prevent plunger blow-out
- Single-acting, gravity-return

▼ Only the extreme low-height LPL-cylinder fits in this confined area to lift the construction. The lock nut provides positive and safe mechanical load holding over a long period of time.



## The Lowest Power Lifter



### Integrated Tilt Saddles

All LPL-Series cylinders include integral tilt saddles with maximum tilt angles up to 5°.



### The Summit Edition

Innovation is at the heart of the new Summit Edition cylinders, delivering the high-quality construction that you expect from Enerpac. Their durability ensures your job is done safely and reliably.

- Replaceable plunger support bearing adds support for eccentric loads \*
- Nitrocarburization surface treatment for improved load and wear resistance and corrosion protection
- Replaceable composite bearing surrounds the seal, providing support for eccentric loads
- Low-wear, high-pressure seals provide longer service life.

\* Eccentric load (or “side-load”) is inevitable in heavy lifting. Enerpac's unique *Summit Edition* features provide the ultimate protection against side load. Increased bearing surface maintains stability, and nitrocarburization treatment prevents scoring on the inside of the cylinder. Side-load poses a real problem.... our new cylinder features are the solution!

Cylinder Capacity (ton)	Stroke (in)	Model Number	Maximum Cylinder Cap. at 10,150 psi (ton)	Side-load Resistance of Maximum Capacity	Cylinder Effective Area (in <sup>2</sup> )
60	1.97	LPL-602	68	10%	13.42
100	1.97	LPL-1002	113	10%	22.19
150	1.77	LPL-1602	179	8%	35.18
200	1.77	LPL-2002	223	8%	43.95
250	1.77	LPL-2502	286	5%	56.27
400	1.77	LPL-4002	450	5%	88.75
500	1.77	LPL-5002	575	5%	113.25

# Single Acting, Low Height Lock-Nut Cylinders



## IMPORTANT!

All LPL-Series cylinders require a solid lifting surface for correct support. The use of these cylinders on surfaces such as sand, mud or dirt, may result in cylinder damage.

**INCORRECT!**

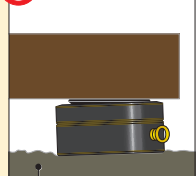

Rough soil

**CORRECT!**

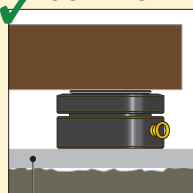

Flat lifting surface

For more safety instructions see our 'Learning Center' on [www.enerpac.com](http://www.enerpac.com)

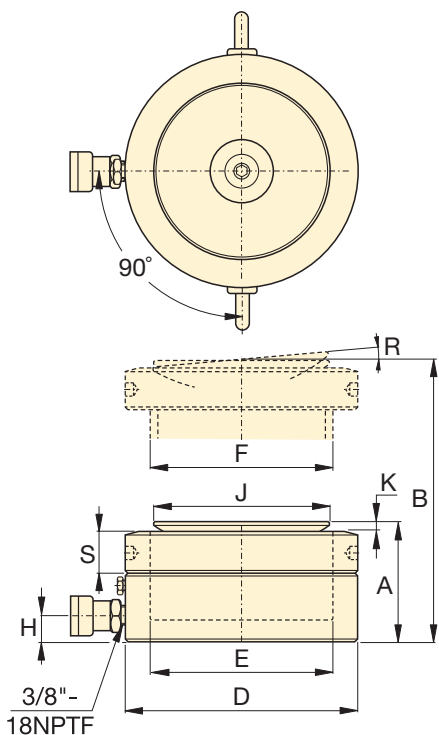

## LPL Series



Capacity:  
**60 - 500 ton**

Stroke:  
**1.77 - 1.97 inch**

Maximum Operating Pressure:  
**10,150 psi**



### Longer Stroke Lock-Nut Cylinders

For longer stroke applications HCL-Series Lock-Nut Cylinders are the perfect choice.

Page: **4**



### Split-Flow Pumps

SFP-Series pumps with multiple outlets with equal oil flow. For lifting and lowering applications on multiple points these pumps are a far better alternative than using separately operated pumps.

Page: **118**



### Synchronous Lifting Systems

Pumps for multiple lift-point capabilities. The economical EVOB-Series for basic applications and the multi-functional EVO-Series lifting system.

Page: **120**

Oil Capacity	Collapsed Height	Extended Height	Outside Diameter	Cylinder Bore Diameter	Plunger Diameter	Base to Advance Port	Saddle Diameter	Saddle Protrusion from Plunger	Saddle Max. Tilt Angle	Lock Nut Height	Wt.	Model Number
(in <sup>3</sup> )	A (in)	B (in)	D (in)	E (in)	F (mm)	H (in)	J (in)	K (in)	R (degrees)	S (in)	(lbs)	
26.4	4.94	6.91	5.51	4.13	Tr 105 x 4	0.75	3.78	0.26	5°	1.10	33	LPL-602
43.7	5.39	7.36	6.81	5.31	Tr 135 x 6	0.83	4.96	0.31	5°	1.22	54	LPL-1002
62.3	5.83	7.60	8.66	6.69	Tr 170 x 6	1.06	6.30	0.35	5°	1.57	94	LPL-1602
77.9	6.10	7.87	9.65	7.48	Tr 190 x 6	1.18	7.09	0.39	5°	1.69	121	LPL-2002
99.7	6.24	8.01	10.83	8.46	Tr 215 x 6	1.26	7.87	0.45	5°	1.69	155	LPL-2502
157.2	7.01	8.78	13.78	10.63	Tr 270 x 6	1.56	9.84	0.45	4°	2.17	284	LPL-4002
200.6	7.56	9.33	15.75	12.01	Tr 305 x 6	1.91	11.42	0.39	3°	2.42	404	LPL-5002

▼ Shown from left to right: RSM-1000, RSM-300, RSM-50, RCS-1002, RCS-302



## Maximum Power to Height Ratio



### Saddles

All **RCS-Series** cylinders have plunger mounting holes for installation of tilt saddles. See table for selection and dimensional information.

Page: **23**



### Low Clearance Lifting

The **LW-16** Lifting Wedge and **SOH-Series** Machine Lifts are the perfect choices for lifting loads that have low clearance.

Page: **192**

### RSM-Series, Flat-Jac® Cylinders

- Compact, flat design for use where other cylinders will not fit
- RSM-750, 1000 and 1500 have handles for easy carrying
- Mounting holes permit easy fixturing
- Baked enamel finish for increased corrosion resistance
- CR-400 coupler and dust cap included on all models<sup>1)</sup>
- Hard chrome plated high-quality steel plungers
- Grooved plunger ends require no saddle
- Single-acting spring return

### RCS-Series, Low Height Cylinders

- Lightweight, low profile design for use in confined spaces
- Baked enamel finish for increased corrosion resistance
- Plunger wiper reduces contamination, extending cylinder life
- CR-400 coupler and dust cap included on all models
- Grooved plunger end with threaded holes for mounting tilt saddles
- Integral handle on RCS-1002 for easy carrying
- Plated steel plungers
- Single-acting spring return

▼ Only a couple of inches are needed for an RSM-cylinder to lift this large steel construction.



Cylinder Capacity	Stroke	Model Number	Cyl. Effect. Area	Oil Cap.
(tons) [max.]	(in)		(in <sup>2</sup> )	(in <sup>3</sup> )
5 [4.9]	.25	RSM-50 <sup>1)</sup>	.99	.25
10 [11.2]	.44	RSM-100	2.24	.98
20 [22.1]	.44	RSM-200	4.43	1.94
30 [32.4]	.50	RSM-300	6.49	3.25
50 [48.1]	.63	RSM-500	9.62	6.01
75 [79.5]	.63	RSM-750	15.90	9.94
100 [98.1]	.63	RSM-1000	19.63	12.27
150 [153.4]	.63	RSM-1500	30.68	19.17
10 [11.2]	1.50	RCS-101*	2.24	3.35
20 [22.1]	1.75	RCS-201*	4.43	7.75
30 [32.4]	2.44	RCS-302*	6.49	15.82
50 [48.1]	2.38	RCS-502*	9.62	22.85
100 [98.1]	2.25	RCS-1002*	19.63	44.18

<sup>1)</sup> RSM-50 is fitted with an AR-400 coupler.

\* Available as a set. See note on next page.

# Single-Acting, Low Height Cylinders

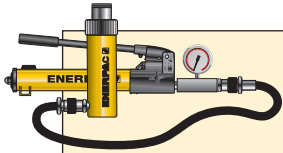

## Pump and Cylinder Sets

All cylinders marked with an \*\* are available as **sets** (cylinder, gauge, couplers, hose and pump) for your ordering convenience.

Page: 52

### Optional Bolt On Tilt Saddle Dimensions (in)

For cylinder model:	Model Number	A	B	C*
RCS-201, -302, -502	CAT-51	1.97	.59	1.14
RCS-1002	CAT-101	2.80	.67	1.39

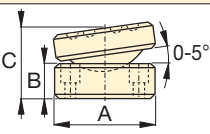

\* "C" dimension equals saddle protrusion from plunger. Mounting screws are included.

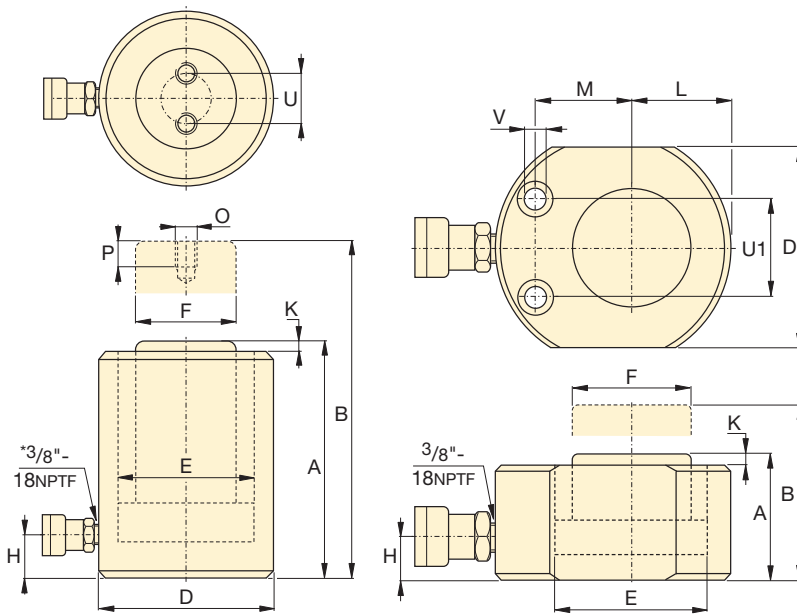

RCS-Series\*\*

RSM-Series

\*\* 5° angle position of coupler on RCS-101, 201, 302.

## RSM RCS Series



Capacity:

**5-150 tons**

Stroke:

**.25-2.44 inches**

Maximum Operating Pressure:

**10,000 psi**

### RSM Cylinder Mounting Hole Dimensions (in)

Model Number	Hole Pitch U1	Hole Diam. V	Counter Bore Diam.	Counter Bore Depth
RSM-50	1.12	.20	.312	.17
RSM-100	1.44	.28	.422	.31
RSM-200	1.94	.40	.594	.39
RSM-300	2.06	.40	.625	.44
RSM-500	2.62	.47	.750	.50
RSM-750	3.00	.53	.812	.56
RSM-1000	3.00	.53	.812	.56
RSM-1500	4.62	.53	.812	.56

Collapsed Height	Extended Height	Outside Diameter	Cylinder Bore Diameter	Plunger Diameter	Base to Advance Port	Plunger Protrusion from Base	Plunger to Base	Plunger to Mtg. Hole	Thread	Thread Depth	Bolt Circle	Weight	Model Number
A (in)	B (in)	D (in)	E (in)	F (in)	H (in)	K (in)	L (in)	M (in)	O (mm)	P (in)	U (in)	(lbs)	
1.28	1.53	2.31 x 1.63	1.13	1.00	.63	.04	.81	.88	-	-	-	2.3	RSM-50 <sup>1)</sup>
1.69	2.13	3.25 x 2.19	1.69	1.50	.75	.04	1.09	1.34	-	-	-	3.1	RSM-100
2.03	2.47	4.00 x 3.00	2.38	2.00	.75	.04	1.56	1.56	-	-	-	6.8	RSM-200
2.31	2.81	4.63 x 3.75	2.88	2.50	.75	.08	1.88	1.75	-	-	-	10	RSM-300
2.63	3.25	5.50 x 4.50	3.50	2.75	.75	.08	2.25	2.13	-	-	-	15	RSM-500
3.13	3.75	6.50 x 5.50	4.50	3.25	.75	.08	2.75	2.63	-	-	-	25	RSM-750
3.38	4.00	7.00 x 6.00	5.00	3.63	.75	.08	3.00	2.94	-	-	-	32	RSM-1000
3.94	4.56	8.50 x 7.50	6.25	4.50	.94	.08	3.75	3.25	-	-	-	58	RSM-1500
3.47	4.97	2.75	1.69	1.50	.69	.20	-	-	M4	.32	1.03	6	RCS-101*
3.88	5.63	3.63	2.38	2.00	.69	.13	-	-	M5	.32	1.57	11	RCS-201*
4.63	7.06	4.00	2.88	2.62	.75	.13	-	-	M5	.32	1.57	15	RCS-302*
4.81	7.19	4.88	3.50	2.75	.94	.08	-	-	M5	.32	1.57	22	RCS-502*
5.56	7.81	6.50	5.00	3.63	1.25	.06	-	-	M8	.40	2.17	46	RCS-1002*

▼ Shown from left to right: BRC-25, BRC-46, BRP-306, BRP-606, BRP-106C



## The Ultimate in Pulling Power



### Gauges

Minimize the risk of over-loading and ensure long, dependable service from your equipment. Refer to the System Components section for a full range of gauges.

Page: 131



### Attachments and Accessories

The BRC-25 and BRC-46 units have base, collar and plunger threads to affix a range of optional attachments and accessories, such as chains, saddles and extension tubes.

Page: 187

- High strength alloy steel construction
- Plunger blow-out protection to prevent over-extension
- Hard chrome-plated plunger for long life
- Baked enamel finish for increased corrosion resistance
- CR-400 coupler and dust cap included on all models
- Plunger wiper reduces contamination, extending cylinder life
- Single-acting spring-return
- Replaceable links on BRP-models

▼ Ship building, welding and Enerpac pull cylinders go hand in hand.



▼ To lift a load bearing mast into place, BRP cylinders were used to tension the supporting cables.



# Single-Acting, Pull Cylinders

Model Number	Base Mounting Hole V	Collar Thread W	Collar Thread Length X	Mtg. Thread Length Z
<b>BRC-25</b>	3/4"-14 NPT	1 1/2"-16 UN	.98	.67
<b>BRC-46</b>	1 1/4"-11 1/2" NPT	2 1/4"-14 UN	1.06	.98
<b>BRC-106</b>	M30 x 2	M85 x 2	1.02	.98

**BRC  
BRP  
Series**



Capacity:

**2.5-60 tons**

Stroke:

**5.00-6.00 inches**

Maximum Operating Pressure:

**10,000 psi**

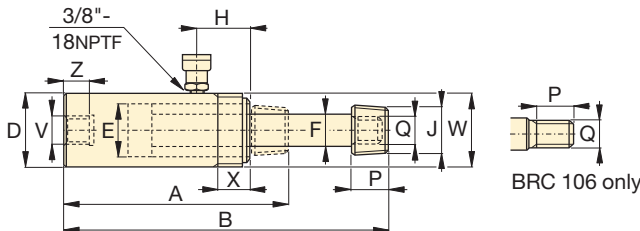

**BRC-25 to BRC-106**

Cylinder Capacity (tons) [maximum]	Stroke (in)	Model Number	Cyl. Effect. Area (in <sup>2</sup> )	Oil Cap. (in <sup>3</sup> )	Collap. Height A (in)	Ext. Height B (in)	Outside Diam. D (in)	Cyl. Bore Diam. E (in)	Plgr. Diam. F (in)	Top to Inlet Port H (in)	Saddle Diameter J (in)	Plunger Thread Length P (in)	Plunger Outside Thread Q	Weight (lbs)
<b>2.5</b> [2.7]	5.00	<b>BRC-25</b>	.55	2.76	10.44	15.44	1.89	1.13	.75	1.77	3/4"-14 NPT	1.13	1 1/16"-24	4
<b>5</b> [5.6]	5.50	<b>BRC-46</b>	1.13	6.21	11.88	17.38	2.25	1.69	1.19	1.69	1 1/4"-11 1/2" NPT	1.25	1 3/16"-16	10
<b>10</b> [11.6]	5.95	<b>BRC-106</b>	2.32	13.80	11.38	17.33	3.35	2.13	1.25	1.57	-	1.02	M30x2	21

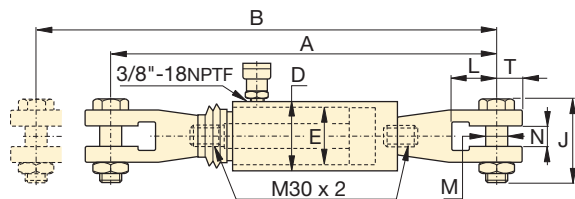

**BRP-106C**

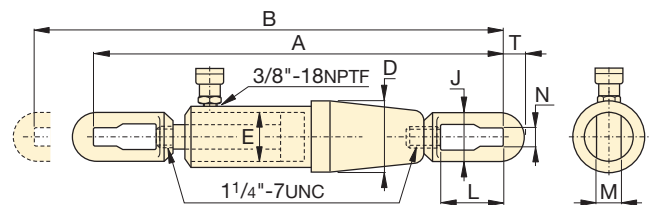

**BRP-306**

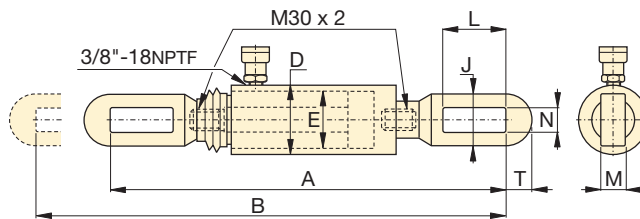

**BRP-106L**

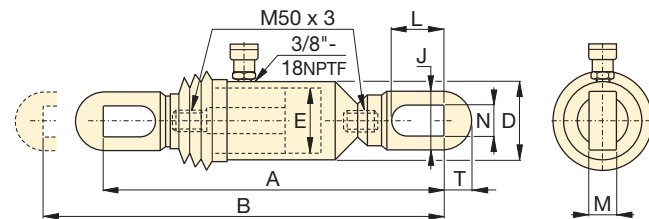

**BRP-606**

Cylinder Capacity (tons) [maximum]	Stroke (in)	Model Number	Cyl. Effect. Area (in <sup>2</sup> )	Oil Capacity (in <sup>3</sup> )	Collap. Height A (in)	Ext. Height B (in)	Outside Diam. D (in)	Cyl. Bore Diam. E (in)	Link Height J (in)	Link Opening L (in)	Link Thickness M (in)	Link Width N (in)	Slot to Link End T (in)	Weight (lbs)
<b>10</b> [11.6]	5.91	<b>BRP-106C</b>	2.45	14.58	23.66	29.57	3.35	2.13	4.13	3.43	1.18	1.38	1.28	34
	5.91	<b>BRP-106L</b>	2.45	14.58	22.87	28.78	3.35	2.13	2.52	4.69	0.87	1.34	1.26	29
<b>30</b> [36.1]	6.10	<b>BRP-306</b>	7.19	43.63	43.71	49.71	5.39	3.50	4.49	6.10	1.38	1.70	2.17	139
<b>60</b> [58.8]	6.00	<b>BRP-606</b>	11.17	67.02	28.28	34.28	5.51	4.33	5.12	5.93	1.58	1.89	2.56	129

Note: BRP-106C, BRP-106L and BRP-606 are fitted with rubber bellows for rod protection.

▼ Shown from left to right: RCH-306, RCH-120, RCH-1003



- Hollow plunger design allows for both pull and push forces
- Single-acting spring return
- Nickel-plated, floating center tube on models over 20 tons increases product life
- Baked enamel finish for increased corrosion resistance
- Collar threads for easy fixturing
- RCH-120 includes AR-630 coupler and has 1/4 NPTF port
- RCH-121 and RCH-1211 have FZ-1630 reducer and AR-630 coupler, all other models feature CR-400 coupler

▼ Hollow plunger cylinder RCH-1003 used in an application for intermediate boom suspension on a dragline.



## Versatility in Testing, Maintenance and Tensioning Applications

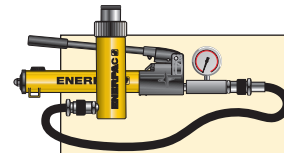

### Pump and Cylinder Sets

All cylinders marked with an \* are available as **sets** (cylinder, gauge, couplers, hose and pump) for your ordering convenience.

Page: 52



### Lightweight Aluminum Hollow Plunger Cylinders

If you need a higher cylinder capacity-to-weight ratio the lightweight **RACH-Series**

Aluminum Hollow Plunger Cylinders are the perfect choice.

Page: 16



### Saddles

Most **RCH-Series** cylinders are equipped with smooth saddles. See table at next page for optional threaded saddles and all dimensional information.

Page: 27

Cylinder Capacity	Stroke	Model Number	Cyl. Effect. Area	Oil Cap.
(tons) [maximum]	(in)		(in <sup>2</sup> )	(in <sup>3</sup> )
<b>12</b> [13.8]	0.31	<b>RCH-120</b>	2.76	0.86
	1.63	<b>RCH-121*</b>	2.76	4.49
	1.63	<b>RCH-1211</b>	2.76	4.49
	3.00	<b>RCH-123</b>	2.76	8.29
<b>20</b> [23.6]	2.00	<b>RCH-202*</b>	4.72	9.46
	6.10	<b>RCH-206</b>	4.72	28.67
<b>30</b> [36.1]	2.50	<b>RCH-302*</b>	7.22	18.05
	6.13	<b>RCH-306</b>	7.22	44.23
<b>60</b> [63.6]	3.00	<b>RCH-603*</b>	12.73	38.20
	6.00	<b>RCH-606</b>	12.73	76.41
<b>100</b> [103.1]	3.00	<b>RCH-1003*</b>	20.63	61.88

\* Available as a set. See note on this page.

# Single-Acting, Hollow Plunger Cylinders



## Hoses

Enerpac offers a complete line of high quality hydraulic hoses. To ensure the integrity of your system, specify only Enerpac hydraulic hoses.

Page: 132

## Optional Heat Treated Hollow Saddles

Saddle Type	Cylinder Model No.	Saddle Model No.	Saddle Dimensions (in)		
			A	B	C
Threaded Hollow	RCH-202, 206	HP-2015	2.11	1"-8	.38
	RCH-302, 306	HP-3015	2.49	1 1/4"-7	.38
	RCH-603, 606	HP-5016	3.61	1 5/8"-5 1/2"	.50
	RCH-1003	HP-10016	4.97	2 1/2"-8	.51

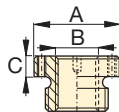

Smooth hollow saddles are standard on all RCH-models (12-ton models are not equipped with saddles).

RCH-121 and RCH-1211 have a 1.88" diameter boss that protrudes 0.25" from base.

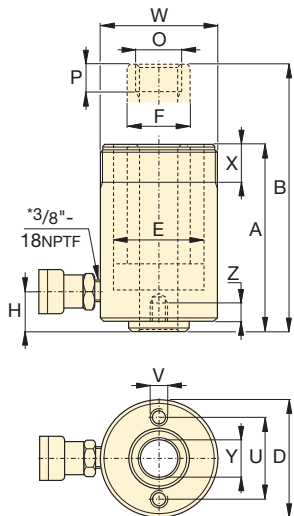

RCH-120\* to RCH-123 models

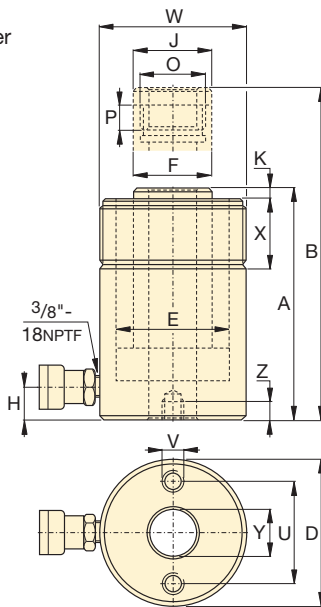

RCH-202 to RCH-1003 models

\* 1/4" NPT for RCH-120 only

## RCH Series



Capacity:

**12-100 tons**

Stroke:

**.31-6.13 inches**

Center Hole Diameter:

**.68-3.11 inches**

Maximum Operating Pressure:

**10,000 psi**

## Base Mounting Hole Dimensions (in)

Model Number	Bolt Circle		
	U	V	Z
RCH-120	2.00	5/16"-18 UNC	.35
RCH-121	-	-	-
RCH-1211	-	-	-
RCH-123	2.00	5/16"-18 UNC	.50
RCH-202	3.25	3/8"-16 UNC	.37
RCH-206	3.25	3/8"-16 UNC	.37
RCH-302	3.63	3/8"-16 UNC	.55
RCH-306	3.63	3/8"-16 UNC	.55
RCH-603	5.13	1/2"-13 UNC	.55
RCH-606	5.13	1/2"-13 UNC	.55
RCH-1003	7.00	5/8"-11 UNC	.75

Collap. Height	Ext. Height	Outside Diam.	Cyl. Bore Diam.	Plngr. Diam.	Cyl. Base to Advance Port	Saddle Diameter	Saddle Protrusion from Plngr.	Plunger Internal Thread	Plunger Thread Length	Collar Thread	Collar Thread Length	Center Hole Diam.	Weight	Model Number
A (in)	B (in)	D (in)	E (in)	F (in)	H (in)	J (in)	K (in)	O (in)	P (in)	W (in)	X (in)	Y (in)	(lbs)	
2.19	2.50	2.75	2.13	1.38	.38	-	-	3/4"-16 UN	.63	2 3/4"-16	1.19	.68	3.2	RCH-120
4.75	6.38	2.75	2.13	1.38	.98	-	-	-	-	2 3/4"-16	1.19	.77	6.2	RCH-121*
4.75	6.38	2.75	2.13	1.38	.98	-	-	3/4"-16 UN	.63	2 3/4"-16	1.19	.68	6.2	RCH-1211
7.25	10.25	2.75	2.13	1.38	.98	-	-	-	-	2 3/4"-16	1.19	.77	9.8	RCH-123
6.38	8.38	3.88	2.88	2.13	.75	2.13	.27	1 9/16"-16 UN	.75	3 7/8"-12	1.50	1.06	17	RCH-202*
12.05	18.11	3.88	2.88	2.13	.75	2.13	.27	1 9/16"-16 UN	.75	3 7/8"-12	1.50	1.06	31	RCH-206
7.03	9.53	4.50	3.50	2.50	.85	2.50	.38	1 13/16"-16 UN	.88	4 1/2"-12	1.66	1.31	24	RCH-302*
13.00	19.13	4.50	3.50	2.50	1.00	2.50	.38	1 13/16"-16 UN	.88	4 1/2"-12	1.66	1.31	48	RCH-306
9.75	12.75	6.25	4.88	3.63	1.25	3.61	.50	2 3/4"-16 UN	.75	6 1/4"-12	1.91	2.12	62	RCH-603*
12.75	18.75	6.25	4.88	3.63	1.25	3.61	.50	2 3/4"-16 UN	.75	6 1/4"-12	1.91	2.12	78	RCH-606
10.00	13.00	8.38	6.50	5.00	1.50	4.97	.50	4"-16 UN	1.00	8 3/8"-12	2.38	3.11	132	RCH-1003*



▼ Shown from left to right: RRH-3010, RRH-1001, RRH-6010



## Versatility in Testing, Maintenance and Tensioning Applications



### Pump Selection

A double-acting cylinder must be powered by a pump with a 4-way valve.

Page: 123



### Gauges

Minimize the risk of overloading and ensure long, dependable service from your equipment. Refer to the System Components section for a full range of gauges.

Page: 131



### Saddles

All RRH-Series cylinders are equipped with smooth saddles. See table on next page for optional threaded saddles and all dimensional information.

Page: 29

- Relief valves prevent damage in case of over-pressurization
- Baked enamel finish for increased corrosion resistance
- Collar threads enable easy fixturing (except RRH-1001 and RRH-1508)
- Double-acting operation for fast retraction
- Nickel-plated, floating center tube increases product life
- Hollow plunger allows for both pull and push forces
- CR-400 couplers and dust caps included on all models
- Plunger wiper reduces contamination, extending cylinder life

▼ Double-acting hollow-plunger cylinders are applied for bridge launching systems.



Cylinder Capacity (ton)	Stroke (in)	Model Number	Max. Cylinder Capacity (ton)		Cylinder Effective Area (in <sup>2</sup> )		Oil Capacity (in <sup>3</sup> )	
			Advance	Retract	Advance	Retract	Advance	Retract
30	7.00	RRH-307	36	24	7.22	4.71	50.55	32.99
	10.13	RRH-3010	36	24	7.22	4.71	73.12	47.71
60	3.50	RRH-603	64	42	12.73	8.37	44.57	29.21
	6.50	RRH-606	64	42	12.73	8.37	82.77	54.24
	10.12	RRH-6010	64	42	12.73	8.37	128.94	84.49
100	1.50	RRH-1001	103	68	20.63	13.54	30.94	20.32
	3.00	RRH-1003	103	68	20.63	13.54	61.88	40.64
	6.00	RRH-1006	103	68	20.63	13.54	123.76	81.29
	10.13	RRH-10010	103	68	20.63	13.54	208.84	137.17
150	8.00	RRH-1508	158	80	31.62	15.91	252.97	127.23

# Double-Acting, Hollow Plunger Cylinders



## Hoses

Enerpac offers a complete line of high-quality hydraulic hoses. To ensure the integrity of your system, specify only Enerpac hydraulic hoses.

Page: 132

## RRH Series



Capacity:

**30-150 tons**

Stroke:

**1.50-10.13 inches**

Center Hole Diameter:

**1.31-3.13 inches**

Maximum Operating Pressure:

**10,000 psi**

### Optional Heat Treated Saddles

Saddle Type	Cylinder Model Number	Saddle Model No.	Saddle Dimensions (in)		
			A	B	C
Threaded Hollow	RRH-307, 3010	HP-3015	2.49	1 1/4"-7	.38
	RRH-603, 606, 6010	HP-5016	3.61	1 5/8"-5 1/2	.50
	RRH-1001, 1003, RRH-1006, 10010	HP-10016	4.97	2 1/2"-8	.51

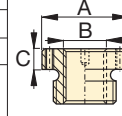

Smooth hollow saddles are standard on all RRH-models.

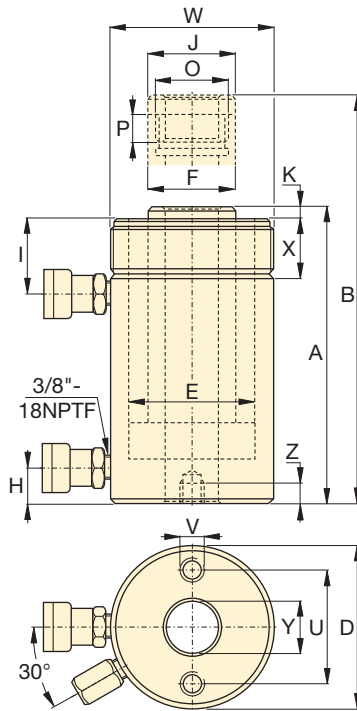

### Base Mounting Hole Dimensions (in)

Model Number	Bolt Circle U	Thread V	Thread Depth Z
RRH-307	3.63	3/8" - 16	.62
RRH-3010	3.63	3/8" - 16	.62
RRH-603	5.12	1/2" - 13	.55
RRH-606	5.12	1/2" - 13	.55
RRH-6010	5.12	1/2" - 13	.55
RRH-1001	7.00	5/8" - 11	.75
RRH-1003	7.00	5/8" - 11	.75
RRH-1006	7.00	5/8" - 11	.75
RRH-10010	7.00	5/8" - 11	.75
RRH-1508	-	-	-

Collap. Height A (in)	Ext. Height B (in)	Out. Diam. D (in)	Cyl. Bore Diam. E (in)	Plngr. Diam. F (in)	Cyl. Base to Adv. Port H (in)	Cyl. Top to Return Port I (in)	Saddle Diam. J (in)	Saddle Protrusion from Plngr. K (in)	Thread O (in)	Plunger Thread Length P (in)	Collar Thread W (in)	Collar Thread Length X (in)	Center Hole Diam. Y (in)	Wt. (lbs)	Model Number
13.00	20.00	4.50	3.50	2.50	1.00	2.38	2.50	.38	1 13/16"-16	.88	4 1/2"-12	1.66	1.31	48	RRH-307
17.00	27.13	4.50	3.50	2.50	1.00	2.38	2.50	.38	1 13/16"-16	.88	4 1/2"-12	1.66	1.31	60	RRH-3010
9.75	13.25	6.25	4.88	3.63	1.25	2.63	3.61	.50	2 3/4"-16	.75	6 1/4"-12	1.91	2.13	62	RRH-603
12.75	19.25	6.25	4.88	3.63	1.25	2.63	3.61	.50	2 3/4"-16	.75	6 1/4"-12	1.91	2.13	78	RRH-606
17.25	27.38	6.25	4.88	3.63	1.25	2.63	3.61	.50	2 3/4"-16	.75	6 1/4"-12	1.91	2.13	101	RRH-6010
6.50	8.00	8.38	6.50	5.00	1.50	1.75	4.97	.50	4"-16	1.00	-	-	3.13	85	RRH-1001
10.00	13.00	8.38	6.50	5.00	1.50	3.38	4.97	.50	4"-16	1.00	8 3/8"-12	2.38	3.13	135	RRH-1003
13.50	19.50	8.38	6.50	5.00	1.50	3.38	4.97	.50	4"-16	1.00	8 3/8"-12	2.38	3.13	175	RRH-1006
18.13	28.25	8.38	6.50	5.00	1.50	3.38	4.97	.50	4"-16	1.00	8 3/8"-12	2.38	3.13	235	RRH-10010
13.75	21.75	9.75	7.50	6.00	1.50	2.38	5.00	.19	4 1/4"-12	1.00	-	-	3.13	245	RRH-1508

▼ Shown from left to right: RD-2510, RD-96, RD-256, RD-41, RD-166



## High Precision and High Cycle Performance



### Speed Chart

See the Enerpac Cylinder Speed Chart in our 'Yellow Pages' to determine your approximate cylinder speed.

Page: 283

- Designed for long life, the best choice for production applications
- Unique mounting configurations simplify fixturing
- Baked enamel finish for increased corrosion resistance
- Double-acting operation develops force in both directions, providing maximum versatility
- Plunger wiper reduces contamination, extending cylinder life

▼ Clamping application using Enerpac RD cylinders (with clevis eye attachments on both ends) for their high-pressure capability and mounting flexibility.

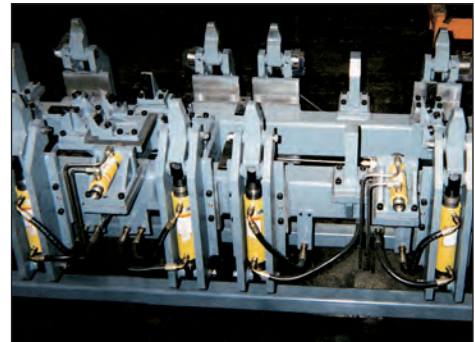

Cylinder Capacity (tons)	Stroke (in)	Model Number	Max. Cylinder Capacity (tons)		Cylinder Effective Area (in <sup>2</sup> )		Oil Capacity (in <sup>3</sup> )		Collap. Height A (in)	Ext. Height B (in)	Body Length C (in)	Outside Diam. D (in)	Cylinder Bore Diam. E (in)	Plunger Diam. F (in)
			Advance	Retract	Advance	Retract	Advance	Retract						
4	1.13	RD-41	4	2	.79	.34	.88	.39	7.31	8.44	6.38	2.00	1.00	.75
	3.13	RD-43	4	2	.79	.34	2.45	1.07	9.31	12.44	8.38	2.00	1.00	.75
	6.13	RD-46	4	2	.79	.34	4.81	2.10	12.31	18.44	11.38	2.00	1.00	.75
9	1.13	RD-91	9	5	1.77	.98	1.99	1.10	8.75	9.88	7.80	2.50	1.50	1.00
	3.13	RD-93	9	5	1.77	.98	5.52	3.07	10.78	13.91	9.80	2.50	1.50	1.00
	6.13	RD-96	9	5	1.77	.98	10.82	6.01	13.78	19.91	12.80	2.50	1.50	1.00
	10.13	RD-910	9	5	1.77	.98	17.89	9.94	17.78	27.91	16.81	2.50	1.50	1.00
16	6.25	RD-166	16	8	3.14	1.66	19.63	10.35	15.31	21.56	14.13	3.00	2.00	1.38
	10.25	RD-1610	16	8	3.14	1.66	32.20	16.98	19.31	29.56	18.11	3.00	2.00	1.38
25	6.25	RD-256	25	11	4.91	2.15	30.68	13.42	16.69	22.94	15.63	3.63	2.50	1.88
	10.25	RD-2510	25	11	4.91	2.15	50.31	22.01	20.69	30.94	19.61	3.63	2.50	1.88

# Double-Acting, Precision Production Cylinders

## ▼ RD CYLINDER ATTACHMENTS

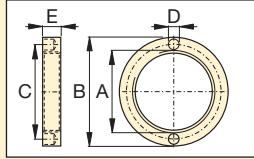

**Retainer Nut**  
For locking foot or flange mountings. Tightens onto cylinder collar threads (included with foot and flange mounting kits)

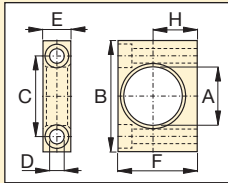

**Foot Mounting**  
Mounts onto cylinder collar. Mounting screws not included.

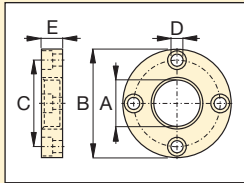

**Flange Mounting**  
Mounts onto cylinder collar. Mounting screws not included.

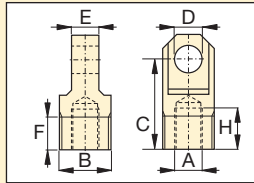

**Clevis Eye**  
Threads onto plunger or into cylinder base

## RD Series



Capacity:  
**4-25 tons**

Stroke:  
**1.13-10.25 inches**

Maximum Operating Pressure:  
**10,000 psi**

Model Number	RD-Cyl: (tons)	Dimensions (in)							
		A	B	C	D	E	F	H	
<b>Foot Mounting with Retainer Nut</b>									
AD-141	4	1.38	3.00	2.00	.41	.75	2.25	1.25	
AD-171	9	2.00	4.00	2.88	.53	1.00	3.25	1.75	
AD-181	16	2.63	5.00	3.75	.78	1.38	4.00	2.06	
AD-191	25	3.25	6.25	4.62	1.03	1.75	4.88	2.50	
<b>Flange Mounting with Retainer Nut</b>									
AD-142	4	1.38	3.88	3.09	.41	.75	-	-	
AD-172	9	2.00	4.75	3.88	.41	1.00	-	-	
AD-182	16	2.63	5.63	4.56	.53	1.38	-	-	
AD-192	25	3.25	6.50	5.34	.66	1.75	-	-	
<b>Retainer Nut</b>									
AD-143	4	1.375-12 UNF	2.25	1.81	.25	.38	-	-	
AD-173	9	2.000-12 UN	3.00	2.50	.27	.50	-	-	
AD-183	16	2.625-16 UN	3.63	3.12	.27	.75	-	-	
AD-193	25	3.250-16 UN	4.25	3.75	.27	1.00	-	-	
<b>Clevis Eye</b>									
AD-150	4	.500-20 UNF	1.125-20 UN	2.06	.63	.62	.75	.94	
AD-151	9	.750-16 UNF	1.688-18 UNEF	2.25	.75	1.00	1.00	.94	
AD-152	16	1.125-12 UNF	2.188-16 UNS	3.06	1.00	1.25	1.00	1.19	
AD-153	25	1.500-12 UNF	2.750-16	3.06	1.25	1.50	1.00	1.06	

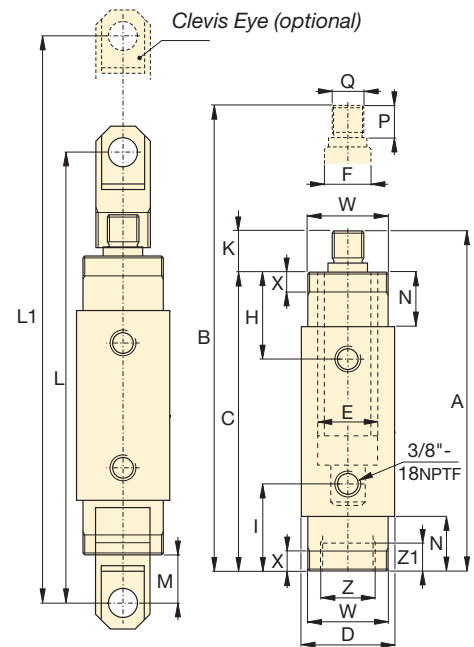

Top to Ret. Port H (in)	Bottom to Adv. Port I (in)	Plunger Protrusion K (in)	Clevis Eye Mounting Dimensions			Neck Length N (in)	Plunger Thread Length P (in)	Plunger External Thread Q (in)	Cylinder Mounting Dimensions (in)				Wt. (lbs)	Model Number
			L (in)	L1 (in)	M (in)				Collar Thread W	Collar Thread Length X	Int. Base Thread Z	Int. Base Thread Length Z1		
1.88	1.88	.94	10.12	11.25	1.61	1.13	.75	1/2"-20	1 3/8"-12	.44	1 1/8"-20	.35	4.8	RD-41
1.88	1.88	.94	12.12	15.25	1.61	1.13	.75	1/2"-20	1 3/8"-12	.44	1 1/8"-20	.35	6.4	RD-43
1.88	1.88	.94	15.12	21.25	1.61	1.13	.75	1/2"-20	1 3/8"-12	.44	1 1/8"-20	.35	9.0	RD-46
2.27	2.27	.98	11.61	12.76	1.50	1.50	.75	3/4"-16	2"-12	.56	1 11/16"-18	.55	9.0	RD-91
2.27	2.27	.98	13.66	16.79	1.50	1.50	.75	3/4"-16	2"-12	.56	1 11/16"-18	.55	11.0	RD-93
2.27	2.27	.98	16.66	22.79	1.50	1.50	.75	3/4"-16	2"-12	.56	1 11/16"-18	.55	14.0	RD-96
2.27	2.27	.98	20.66	30.79	1.50	1.50	.75	3/4"-16	2"-12	.56	1 11/16"-18	.55	19.0	RD-910
2.90	2.90	1.19	19.32	25.57	2.05	2.13	1.00	1 1/8"-12	2 5/8"-16	.88	2 3/16"-16	.94	22.0	RD-166
2.90	2.90	1.19	23.32	33.57	2.05	2.13	1.00	1 1/8"-12	2 5/8"-16	.88	2 3/16"-16	.94	29.0	RD-1610
3.50	3.50	1.06	20.86	27.11	2.09	2.75	1.00	1 1/2"-12	3 1/4"-16	1.13	2 3/4"-16	1.02	36.0	RD-256
3.50	3.50	1.08	24.86	35.11	2.09	2.75	1.00	1 1/2"-12	3 1/4"-16	1.13	2 3/4"-16	1.02	46.0	RD-2510

▼ Shown from left to right: RR-10013, RR-1502, RR-20013, RR-1010, RR-7513



## Most Versatile Performers

Rugged enough for the toughest job site uses and precision designed for high-cycle industrial uses.



### Pump Selection

A double-acting cylinder must be powered by a pump with a 4-way valve.

Page: 123



### Saddles

RR-Series cylinders up to 75-ton have plunger thread for installation of CAT-Series tilt saddles.

Page: 33



### Optimum Performance

Enerpac's range of Z-Class electric pumps, fitted with manual or solenoid operated 4-way valves, offer optimum combinations with RR cylinders.

Page: 90

- Collar threads, plunger threads and base mounting holes for easy fixturing (on most models)
- Baked enamel finish for increased corrosion resistance
- Removable hardened saddles protect plunger during lifting and pressing
- Built-in safety valve prevents accidental over-pressurization
- CR-400 couplers included on all models
- Plunger wiper reduces contamination, extending cylinder life

▼ These long stroke RR-cylinders are attached to a sliding and guiding system pulling the arched roof assembly of Athen's Olympic Stadium step-by-step into the final position.



▼ RR-cylinders provide power and precision in a special hydraulic press.



# Double-Acting Long Stroke Cylinders

## ▼ QUICK SELECTION CHART

For complete technical information see next page.

Cylinder Capacity (tons)	Stroke (in)	Model Number	Cylinder Effective Area (in <sup>2</sup> )		Oil Capacity (in <sup>3</sup> )		Collap. Height (in)
			Push	Pull	Push	Pull	
			10	10.00	RR-1010*	2.23	
	12.00	RR-1012*	2.23	.80	26.80	9.00	18.00
30	8.25	RR-308*	6.51	3.00	53.67	25.00	15.25
	14.50	RR-3014*	6.51	3.00	92.70	43.00	21.63
50	6.13	RR-506	11.06	3.40	67.77	21.00	13.06
	13.13	RR-5013	11.06	3.40	145.17	44.00	20.06
	20.13	RR-5020	11.06	3.40	222.56	68.00	28.88
75	6.13	RR-756	15.92	4.90	97.58	29.00	13.69
	13.13	RR-7513	15.92	4.90	209.00	64.00	20.69
100	6.63	RR-1006	20.65	9.60	136.93	63.00	14.06
	13.13	RR-10013	20.65	9.60	271.17	126.00	20.63
	18.13	RR-10018	20.65	9.60	374.44	174.00	27.06
150	2.25	RR-1502	30.71	14.80	69.11	33.00	7.72
	6.13	RR-1506	30.71	14.80	188.28	91.00	15.19
	13.13	RR-15013	30.71	14.80	403.27	194.00	22.20
	32.13	RR-15032	30.71	14.80	986.84	475.00	43.94
200	6.00	RR-2006	44.21	22.50	265.28	135.00	16.94
	13.00	RR-20013	44.21	22.50	574.78	293.00	23.94
	18.00	RR-20018	44.21	22.50	795.85	396.00	30.13
	24.00	RR-20024	44.21	22.50	1,061	528.00	36.13
	36.00	RR-20036	44.21	22.50	1,592	792.00	48.13
	48.00	RR-20048	44.21	22.50	2,122	1,056	60.13
300	6.00	RR-3006	70.93	38.00	425.56	228.00	19.13
	12.00	RR-30012	70.93	38.00	851.12	456.00	25.13
	18.00	RR-30018	70.93	38.00	1,277	684.00	31.13
	24.00	RR-30024	70.93	38.00	1,702	912.00	37.13
	36.00	RR-30036	70.93	38.00	2,553	1,368	49.13
	48.00	RR-30048	70.93	38.00	3,405	1,824	61.13
400	6.00	RR-4006	95.09	51.00	570.51	306.00	21.19
	12.00	RR-40012	95.09	51.00	1,141	612.00	27.19
	18.00	RR-40018	95.09	51.00	1,712	918.00	33.19
	24.00	RR-40024	95.09	51.00	2,282	1,224	39.19
	36.00	RR-40036	95.09	51.00	3,423	1,836	51.19
	48.00	RR-40048	95.09	51.00	4,564	2,448	63.19
500	6.00	RR-5006	113.15	63.00	678	378.00	22.75
	12.00	RR-50012	113.15	63.00	1,358	756.00	28.75
	18.00	RR-50018	113.15	63.00	2,037	1,134	34.75
	24.00	RR-50024	113.15	63.00	2,716	1,512	40.75
	36.00	RR-50036	113.15	63.00	4,074	2,264	52.75
	48.00	RR-50048	113.15	63.00	5,431	3,024	64.75

## RR Series



Capacity:

**10-500 tons**

Stroke:

**2.25-48.00 inches**

Maximum Operating Pressure:

**10,000 psi**



### Enerpac HCR-Series

If you do not have a high-cycle application, Enerpac **HCR-Series** cylinders may be the right alternative.

Page: 44



### Speed Chart

See the Enerpac Cylinder Speed Chart in our "Yellow Pages"

to determine your approximate cylinder speed. Page: 283



### Optional Snap-in Saddles

Optional snap-in saddles for RR-Series double-acting cylinders:

Saddle Type	Cylinder Model Number	Saddle Model Number
Flat	RR-1010, 1012	A-102F
Tilt	RR-1010, 1012	CAT-10
	RR-308, 3014	CAT-50
	RR-506, 5013	CAT-100
	RR-5020, 756	
	RR-7513	

### Standard Saddles

Grooved	RR-1010, 1012	A-102G
	RR-308, 3014	A-252G

For additional information on saddles:

Page: 10

# RR-Series, Double-Acting Cylinders

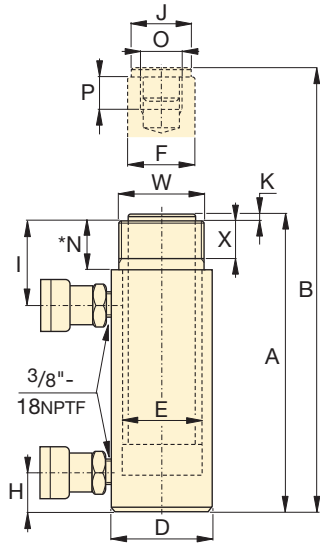

## RR-1010 to RR-3014 models

\* For RR-1010 and RR-1012:  
N = 1.26 inch; for RR-308 and  
RR-3014: N = 2.20 inch.

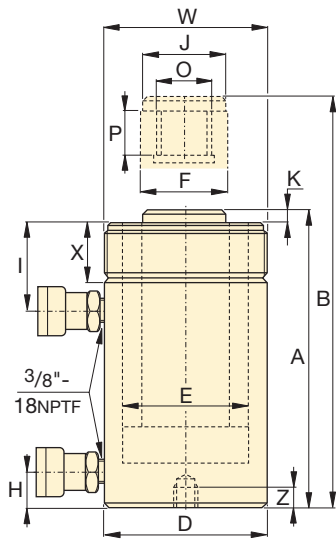

## RR-506 to RR-50048 models

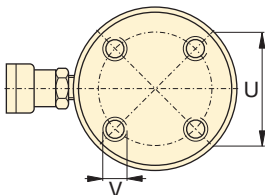

## RR-1006 to RR-30048

No mounting holes:  
RR-506, 5013  
RR-756, 7513  
RR-1502, 15032



Cylinder retract capacity for certain RR cylinders may be less than theoretical values, as a result of reduced relief valve pressure settings:

RR-308/3014: 4000 psi  
RR-506/5013/5020: 6950 psi  
RR-756/7513: 7200 psi

◀ For full features see page 32.

Cylinder Capacity (ton)	Stroke (in)	Model Number	Max. Cylinder Capacity (tons)		Cylinder Effective Area (in <sup>2</sup> )		Oil Capacity (in <sup>3</sup> )		Collap. Height	Ext. Height	Outside Diam.
			Push	Pull	Push	Pull	Push	Pull	A (in)	B (in)	D (in)
10	10.00	RR-1010*	11.1	4.0	2.23	.80	22.33	8.00	16.13	26.13	2.88
	12.00	RR-1012*	11.1	4.0	2.23	.80	26.80	9.00	18.00	30.00	2.88
30	8.25	RR-308*	32.5	6.0	6.51	3.00	53.67	25.00	15.25	23.50	4.00
	14.50	RR-3014*	32.5	6.0	6.51	3.00	92.70	43.00	21.63	36.13	4.00
50	6.13	RR-506	55.3	11.8	11.06	3.40	67.77	21.00	13.06	19.19	5.00
	13.13	RR-5013	55.3	11.8	11.06	3.40	145.17	44.00	20.06	33.19	5.00
	20.13	RR-5020	55.3	11.8	11.06	3.40	222.56	68.00	28.88	49.00	5.00
75	6.13	RR-756	79.6	17.6	15.92	4.90	97.58	29.00	13.69	19.81	5.75
	13.13	RR-7513	79.6	17.6	15.92	4.90	209.00	64.00	20.69	33.81	5.75
100	6.63	RR-1006	103.2	48.0	20.65	9.60	136.93	63.00	14.06	20.69	7.00
	13.13	RR-10013	103.2	48.0	20.65	9.60	271.17	126.00	20.63	33.75	7.00
	18.13	RR-10018	103.2	48.0	20.65	9.60	374.44	174.00	27.06	45.19	7.00
150	2.25	RR-1502	153.5	74.0	30.71	14.80	69.11	33.00	7.19	9.44	8.00
	6.13	RR-1506	153.5	74.0	30.71	14.80	188.28	91.00	15.19	21.31	8.00
	13.13	RR-15013	153.5	74.0	30.71	14.80	403.27	194.00	22.20	35.31	8.00
	32.13	RR-15032	153.5	74.0	30.71	14.80	986.84	475.00	43.94	76.06	8.00
200	6.00	RR-2006	221.0	112.5	44.21	22.50	265.28	135.00	16.94	22.94	9.75
	13.00	RR-20013	221.0	112.5	44.21	22.50	574.78	293.00	23.94	36.94	9.75
	18.00	RR-20018	221.0	112.5	44.21	22.50	795.85	396.00	30.13	48.13	9.75
	24.00	RR-20024	221.0	112.5	44.21	22.50	1,061	528.00	36.13	60.13	9.75
	36.00	RR-20036	221.0	112.5	44.21	22.50	1,592	792.00	48.13	84.13	9.75
300	48.00	RR-20048	221.0	112.5	44.21	22.50	2,122	1,056	60.13	108.13	9.75
	6.00	RR-3006	354.6	190.0	70.93	38.00	425.56	228.00	19.13	25.13	12.25
	12.00	RR-30012	354.6	190.0	70.93	38.00	851.12	456.00	25.13	37.13	12.25
	18.00	RR-30018	354.6	190.0	70.93	38.00	1,277	684.00	31.13	49.13	12.25
	24.00	RR-30024	354.6	190.0	70.93	38.00	1,702	912.00	37.13	61.13	12.25
400	36.00	RR-30036	354.6	190.0	70.93	38.00	2,553	1368	49.13	85.13	12.25
	48.00	RR-30048	354.6	190.0	70.93	38.00	3,405	1824	61.13	109.13	12.25
	6.00	RR-4006	475.4	255.0	95.09	51.00	570.51	306.00	21.19	27.19	14.13
	12.00	RR-40012	475.4	255.0	95.09	51.00	1,141	612.00	27.19	39.19	14.13
	18.00	RR-40018	475.4	255.0	95.09	51.00	1,712	918.00	33.19	51.19	14.13
500	24.00	RR-40024	475.4	255.0	95.09	51.00	2,282	1224	39.19	63.19	14.13
	36.00	RR-40036	475.4	255.0	95.09	51.00	3,423	1836	51.19	87.19	14.13
	48.00	RR-40048	475.4	255.0	95.09	51.00	4,564	2448	63.19	111.19	14.13
	6.00	RR-5006	565.7	315.0	113.15	63.00	678.92	378.00	22.75	28.75	15.63
	12.00	RR-50012	565.7	315.0	113.15	63.00	1,358	756.00	28.75	40.75	15.63
500	18.00	RR-50018	565.7	315.0	113.15	63.00	2,037	1134	34.75	52.75	15.63
	24.00	RR-50024	565.7	315.0	113.15	63.00	2,716	1512	40.75	64.75	15.63
	36.00	RR-50036	565.7	315.0	113.15	63.00	4,074	2268	52.75	88.75	15.63
48.00	RR-50048	565.7	315.0	113.15	63.00	5,431	3024	64.75	112.75	15.63	

\* For RR-1010 and RR-1012: N = 1.26 inch; for RR-308 and RR-3014: N = 2.20 inch.

# Double-Acting Long Stroke Cylinders

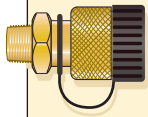

### Couplers Included!

CR-400 couplers included on all models. Fits all HC-Series hoses.

Capacity:  
**10-500 tons**

Stroke:  
**2.25-48.00 inches**

Maximum Operating Pressure:  
**10,000 psi**

## RR Series



Cylinder Bore Diameter	Plunger Diameter	Base to Adv. Port	Top to Return Port	Saddle Diameter	Saddle Protrusion from Plngr.	Plunger Internal Thread	Plunger Thread Length	Base Mounting Holes			Collar Thread	Collar Thread Length	Weight (lbs)	Model Number
								Bolt Cir. Diam.	Thread	Thread Depth				
E (in)	F (in)	H (in)	I (in)	J (in)	K (in)	O (in)	P (in)	U (in)	V (in)	Z (in)	W (in)	X (in)		
1.69	1.38	1.44	2.25	1.38	.24	1-8	1.00	-	-	-	2 1/4-14	1.06	28	RR-1010*
1.69	1.38	1.44	2.25	1.38	.24	1-8	1.00	-	-	-	2 1/4-14	1.06	31	RR-1012*
2.88	2.13	1.44	3.19	2.00	.41	1 1/2-16	1.00	-	-	-	3 5/16-12	1.94	40	RR-308*
2.88	2.13	1.56	3.19	2.00	.41	1 1/2-16	1.00	-	-	-	3 5/16-12	1.94	64	RR-3014*
3.75	3.13	1.13	3.00	2.81	.11	1-12	1.00	-	-	-	5-12	2.00	67	RR-506
3.75	3.13	1.13	3.00	2.81	.11	1-12	1.00	-	-	-	5-12	2.00	115	RR-5013
3.75	3.13	2.25	3.00	2.81	.11	1-12	1.00	3.00	-	-	5-12	2.00	150	RR-5020
4.50	3.75	1.19	3.00	2.81	.25	1-12	1.50	-	-	-	5 3/4-12	1.50	92	RR-756
4.50	3.75	1.19	3.19	2.81	.25	1-12	1.50	-	-	-	5 3/4-12	1.50	150	RR-7513
5.13	3.75	1.50	2.81	3.00	.13	1 3/4-12	1.38	5.50	3/4-10	1.00	6 7/8-12	2.00	135	RR-1006
5.13	3.75	1.50	2.81	3.00	.13	1 3/4-12	1.38	5.50	3/4-10	1.00	6 7/8-12	2.00	205	RR-10013
5.13	3.75	1.63	3.63	3.00	.13	1 3/4-12	1.38	5.50	3/4-10	1.00	6 7/8-12	2.00	260	RR-10018
6.25	4.50	.88	2.63	3.67	.06	-	-	-	-	-	-	-	110	RR-1502
6.25	4.50	1.94	3.31	4.49	.75	3 3/8-16	1.38	6.25	3/4-16	1.00	8-12	2.36	205	RR-1506
6.25	4.50	1.94	3.31	4.49	.75	3 3/8-16	1.38	6.25	3/4-16	1.00	8-12	2.36	275	RR-15013
6.25	4.50	3.31	3.31	4.49	.75	3 3/8-16	1.38	-	-	-	8-12	2.36	525	RR-15032
7.50	5.25	2.25	3.81	5.25	.88	-	-	5.00	1-8	1.00	-	-	325	RR-2006
7.50	5.25	2.25	3.81	5.25	.88	2 1/2-12	2.50	5.00	1-8	1.00	9 3/4-12	2.13	440	RR-20013
7.50	5.25	3.38	4.00	5.25	.88	2 1/2-12	2.50	5.00	1-8	1.00	9 3/4-12	2.13	450	RR-20018
7.50	5.25	3.38	4.00	5.25	.88	2 1/2-12	2.50	5.00	1-8	1.00	9 3/4-12	2.13	616	RR-20024
7.50	5.25	3.38	4.00	5.25	.88	2 1/2-12	2.50	5.00	1-8	1.00	9 3/4-12	2.13	845	RR-20036
7.50	5.25	3.38	4.00	5.25	.88	2 1/2-12	2.50	5.00	1-8	1.00	9 3/4-12	2.13	1065	RR-20048
9.50	6.50	3.50	4.50	6.50	1.13	2 1/2-12	3.25	6.25	1 1/4-7	1.75	12 1/4-12	2.31	441	RR-3006
9.50	6.50	3.50	4.50	6.50	1.13	2 1/2-12	3.25	6.25	1 1/4-7	1.75	12 1/4-12	2.31	608	RR-30012
9.50	6.50	3.50	4.50	6.50	1.13	2 1/2-12	3.25	6.25	1 1/4-7	1.75	12 1/4-12	2.31	776	RR-30018
9.50	6.50	3.50	4.50	6.50	1.13	2 1/2-12	3.25	6.25	1 1/4-7	1.75	12 1/4-12	2.31	1034	RR-30024
9.50	6.50	3.50	4.50	6.50	1.13	2 1/2-12	3.25	6.25	1 1/4-7	1.75	12 1/4-12	2.31	1385	RR-30036
9.50	6.50	3.50	4.50	6.50	1.13	2 1/2-12	3.25	6.25	1 1/4-7	1.75	12 1/4-12	2.31	1720	RR-30048
11.00	7.50	4.25	5.25	7.50	1.13	3-12	3.75	8.00	1 1/2-6	2.00	14 1/8-8	2.56	670	RR-4006
11.00	7.50	4.25	5.25	7.50	1.13	3-12	3.75	8.00	1 1/2-6	2.00	14 1/8-8	2.56	880	RR-40012
11.00	7.50	4.25	5.25	7.50	1.13	3-12	3.75	8.00	1 1/2-6	2.00	14 1/8-8	2.56	1000	RR-40018
11.00	7.50	4.25	5.25	7.50	1.13	3-12	3.75	8.00	1 1/2-6	2.00	14 1/8-8	2.56	1317	RR-40024
11.00	7.50	4.25	5.25	7.50	1.13	3-12	3.75	8.00	1 1/2-6	2.00	14 1/8-8	2.56	1746	RR-40036
11.00	7.50	4.25	5.25	7.50	1.13	3-12	3.75	8.00	1 1/2-6	2.00	14 1/8-8	2.56	2162	RR-40048
12.00	8.00	4.75	6.00	8.00	1.13	3 1/4-12	4.25	8.00	1 3/4-5	2.12	15 5/8-8	3.13	953	RR-5006
12.00	8.00	4.75	6.00	8.00	1.13	3 1/4-12	4.25	8.00	1 3/4-5	2.12	15 5/8-8	3.13	1300	RR-50012
12.00	8.00	4.75	6.00	8.00	1.13	3 1/4-12	4.25	8.00	1 3/4-5	2.12	15 5/8-8	3.13	1500	RR-50018
12.00	8.00	4.75	6.00	8.00	1.13	3 1/4-12	4.25	8.00	1 3/4-5	2.12	15 5/8-8	3.13	1800	RR-50024
12.00	8.00	4.75	6.00	8.00	1.13	3 1/4-12	4.25	8.00	1 3/4-5	2.12	15 5/8-8	3.13	2210	RR-50036
12.00	8.00	4.75	6.00	8.00	1.13	3 1/4-12	4.25	8.00	1 3/4-5	2.12	15 5/8-8	3.13	2700	RR-50048



▼ HCL-1006, HCG-2006, HCR-506



## Highest Level of Durability



### The Summit Edition

Innovation is at the heart of the new *Summit Edition* of cylinders, delivering the high quality construction that you expect from Enerpac. The durability ensures your job gets done safely and reliably.

- Plunger support bearing adds support for eccentric loads <sup>2)</sup>
- Nitrocarburization surface treatment for improved wear resistance and corrosion protection
- Replaceable composite bearings surround the seal providing support for eccentric loads
- Low-wear, high-pressure seals provide longer service life

<sup>2)</sup> Eccentric load (or “side-load”) is inevitable in heavy lifting. Our unique Summit Edition features provide the ultimate protection against side-load. Increased bearing surface maintains stability, and nitrocarburization treatment prevents scoring on the inside of the cylinder. Side-load poses a real problem.... our new cylinder features are the solution!

### Reaching the Summit Edition:

#### Substrate bonded multi-layer treatment

- Hardened surface resists side-loading and cyclic wear
- Weather protected, inside and out
- Low-friction locking rings spin easy, save time and effort <sup>1)</sup>

#### Enclosed polymer bearing system

- Upper and lower bearings enclose the cylinder plunger for support and are able to be replaced along with seals and other soft parts
- State-of-the-art bearing material provides maximum conformity to reduce wear and avoid bore damage even in high side-load conditions

#### Low-wear, high-pressure seals

- Improved geometry and material selection increases seal performance even in harsh conditions
- Low friction improves retraction times

#### Versatile

- Over 200 models in four configurations <sup>1)</sup>
- Certified lifting eyes, base mounting holes and collar threads are included for secure handling and cylinder mounting <sup>1)</sup>

<sup>1)</sup> See specific model’s technical data for more information.

▼ *Bridge lifting and launching system. The load is balanced on groups of lock nut cylinders. The hydraulic movements are synchronized using the Enerpac PLC-controlled synchronous lift systems.*





## High-Tonnage Cylinders

The Enerpac High-Tonnage Cylinders are particularly suitable for (multipoint) lifting applications.

In combination with our state-of-the-art power packs, you will have a world class hydraulic system to perform the most challenging lifting jobs in a safe and professional manner.

### HCG, HCR, HCL-Series Cylinders

- 50 - 1000-ton lifting capacity
- 1.97 - 11.81 inch lifting stroke

### HCG-Series - single-acting

- gravity-return
- stop-ring to prevent plunger blow-out
- designed to withstand up to 10% side-load of maximum capacity

### HCR-Series - double-acting

- hydraulic advance and retract for controlled movement
- designed to withstand up to 10% side-load of maximum capacity

### HCL-Series - lock nut, single-acting

- gravity-return
- lock nut for mechanical load holding
- overflow port to prevent plunger blow out
- designed to withstand 10% side-load up to 90% of maximum stroke

### LPL-Series - lock nut, low height, single-acting

- 60 - 500-ton lifting capacity
- 1.77 - 1.97 inch lifting stroke
- integrated tilt saddle
- gravity-return
- lock nut for mechanical load holding
- 5-10% side-load of maximum capacity

Page: 5



## HCG HCR HCL Series



Capacity:

**50 - 1000 ton**

Stroke:

**1.77 - 11.81 inch.**

Maximum Operating Pressure:

**10,150 psi**



### Assisted-Return Pumps

Enerpac HCG, HCL and LPL-Series cylinders are hydraulic advance and gravity-return. To improve productivity and plunger retraction Enerpac offers assisted return on ZU4 and ZE-Series pumps featuring Enerpac Venturi valve technology, specifically to facilitate the faster return of single-acting, gravity-return cylinders. See [enerpac.com](http://enerpac.com) for details.



### Split-Flow Pumps

SFP-Series pumps with multiple outlets with equal oil flow. For lifting and lowering applications on multiple points, these pumps are a far better alternative than using separately operated pumps.

Page: 118



### Synchronous Lifting Systems

Pumps for multiple lift-point capabilities. The economical **EVOB-Series** for basic applications and the multi-functional **EVO-Series** lifting system.

Page: 120



## QUICK SELECTION

Cylinder Capacity (ton)	Stroke (in)	Maximum Cylinder Capacity at 10,150 psi (ton)	HCG-Series		HCR-Series		HCL-Series	
			Model Number Single-Acting <i>Page: 40</i>	Collapsed Height (in)	Model Number Double-Acting <i>Page: 44</i>	Collapsed Height (in)	Model Number Single-Acting With Lock Nut <i>Page: 48</i>	Collapsed Height (in)
50	1.97	62	HCG-502	7.20	HCR-502	7.20	HCL-502	6.46
	3.94		HCG-504	9.17	HCR-504	9.17	HCL-504	8.43
	5.91		HCG-506	11.14	HCR-506	11.14	HCL-506	10.39
	7.87		HCG-508	13.62	HCR-508	13.62	HCL-508	12.36
	9.84		HCG-5010	15.59	HCR-5010	15.59	HCL-5010	14.33
	11.81		HCG-5012	17.56	HCR-5012	17.56	HCL-5012	16.30
100	1.97	113	HCG-1002	7.95	HCR-1002	7.95	HCL-1002	7.36
	3.94		HCG-1004	9.92	HCR-1004	9.92	HCL-1004	9.33
	5.91		HCG-1006	11.89	HCR-1006	11.89	HCL-1006	11.30
	7.87		HCG-1008	14.92	HCR-1008	14.92	HCL-1008	13.27
	9.84		HCG-10010	16.89	HCR-10010	16.89	HCL-10010	15.24
	11.81		HCG-10012	18.86	HCR-10012	18.86	HCL-10012	17.20
150	1.97	168	HCG-1502	8.66	HCR-1502	8.66	HCL-1502	8.23
	3.94		HCG-1504	10.63	HCR-1504	10.63	HCL-1504	10.20
	5.91		HCG-1506	12.60	HCR-1506	12.60	HCL-1506	12.17
	7.87		HCG-1508	15.63	HCR-1508	15.63	HCL-1508	14.13
	9.84		HCG-15010	17.60	HCR-15010	17.60	HCL-15010	16.10
	11.81		HCG-15012	19.57	HCR-15012	19.57	HCL-15012	18.07
200	1.97	223	HCG-2002	9.09	HCR-2002	9.09	HCL-2002	9.37
	3.94		HCG-2004	11.06	HCR-2004	11.06	HCL-2004	11.34
	5.91		HCG-2006	13.03	HCR-2006	13.03	HCL-2006	13.31
	7.87		HCG-2008	16.06	HCR-2008	16.06	HCL-2008	15.28
	9.84		HCG-20010	18.03	HCR-20010	18.03	HCL-20010	17.24
	11.81		HCG-20012	20.00	HCR-20012	20.00	HCL-20012	19.21
250	1.97	286	HCG-2502	9.49	HCR-2502	9.49	HCL-2502	9.80
	3.94		HCG-2504	11.46	HCR-2504	11.46	HCL-2504	11.77
	5.91		HCG-2506	13.43	HCR-2506	13.43	HCL-2506	13.74
	7.87		HCG-2508	16.97	HCR-2508	16.97	HCL-2508	15.71
	9.84		HCG-25010	18.94	HCR-25010	18.94	HCL-25010	17.68
	11.81		HCG-25012	20.91	HCR-25012	20.91	HCL-25012	19.65
300	1.97	341	HCG-3002	11.65	HCR-3002	11.65	HCL-3002	10.94
	3.94		HCG-3004	13.62	HCR-3004	13.62	HCL-3004	12.91
	5.91		HCG-3006	15.59	HCR-3006	15.59	HCL-3006	14.88
	7.87		HCG-3008	17.56	HCR-3008	17.56	HCL-3008	16.85
	9.84		HCG-30010	19.53	HCR-30010	19.53	HCL-30010	18.82
	11.81		HCG-30012	21.50	HCR-30012	21.50	HCL-30012	20.79

# Enerpac High-Tonnage Cylinders

Capacity:  
**50 - 1000 ton**

Stroke:  
**1.97 - 11.81 inch**

Maximum Operating Pressure:  
**10,150 psi**

**HCG  
HCR  
HCL  
Series**



## QUICK SELECTION

Cylinder Capacity (ton)	Stroke (in)	Maximum Cylinder Capacity at 10,150 psi (ton)	HCG-Series		HCR-Series		HCL-Series	
			Model Number Single-Acting <i>Page: 40</i>	Collapsed Height (in)	Model Number Double-Acting <i>Page: 44</i>	Collapsed Height (in)	Model Number Single-Acting With Lock Nut <i>Page: 48</i>	Collapsed Height (in)
400	1.97	450	HCG-4002	12.64	HCR-4002	12.64	HCL-4002	12.48
	3.94		HCG-4004	14.61	HCR-4004	14.61	HCL-4004	14.45
	5.91		HCG-4006	16.57	HCR-4006	16.57	HCL-4006	16.42
	7.87		HCG-4008	18.54	HCR-4008	18.54	HCL-4008	18.39
	9.84		HCG-40010	20.51	HCR-40010	20.51	HCL-40010	20.35
	11.81		HCG-40012	22.48	HCR-40012	22.48	HCL-40012	22.32
500	1.97	575	HCG-5002	13.54	HCR-5002	13.54	HCL-5002	14.06
	3.94		HCG-5004	15.51	HCR-5004	15.51	HCL-5004	16.02
	5.91		HCG-5006	17.48	HCR-5006	17.48	HCL-5006	17.99
	7.87		HCG-5008	19.45	HCR-5008	19.45	HCL-5008	19.96
	9.84		HCG-50010	21.42	HCR-50010	21.42	HCL-50010	21.93
	11.81		HCG-50012	23.39	HCR-50012	23.39	HCL-50012	23.90
600	1.97	673	HCG-6002	13.86	HCR-6002	13.86	HCL-6002	14.96
	3.94		HCG-6004	15.83	HCR-6004	15.83	HCL-6004	16.93
	5.91		HCG-6006	17.80	HCR-6006	17.80	HCL-6006	18.90
	7.87		HCG-6008	19.76	HCR-6008	19.76	HCL-6008	20.87
	9.84		HCG-60010	21.73	HCR-60010	21.73	HCL-60010	22.83
	11.81		HCG-60012	23.70	HCR-60012	23.70	HCL-60012	24.80
800	1.97	916	HCG-8002	15.91	HCR-8002	15.91	HCL-8002	16.93
	3.94		HCG-8004	17.87	HCR-8004	17.87	HCL-8004	18.90
	5.91		HCG-8006	19.84	HCR-8006	19.84	HCL-8006	20.87
	7.87		HCG-8008	21.81	HCR-8008	21.81	HCL-8008	22.83
	9.84		HCG-80010	23.78	HCR-80010	23.78	HCL-80010	24.80
	11.81		HCG-80012	25.75	HCR-80012	25.75	HCL-80012	26.77
1000	1.97	1196	HCG-10002	17.40	HCR-10002	17.40	HCL-10002	19.06
	3.94		HCG-10004	19.37	HCR-10004	19.37	HCL-10004	21.02
	5.91		HCG-10006	21.34	HCR-10006	21.34	HCL-10006	22.99
	7.87		HCG-10008	23.31	HCR-10008	23.31	HCL-10008	24.96
	9.84		HCG-100010	25.28	HCR-100010	25.28	HCL-100010	26.93
	11.81		HCG-100012	27.24	HCR-100012	27.24	HCL-100012	28.90

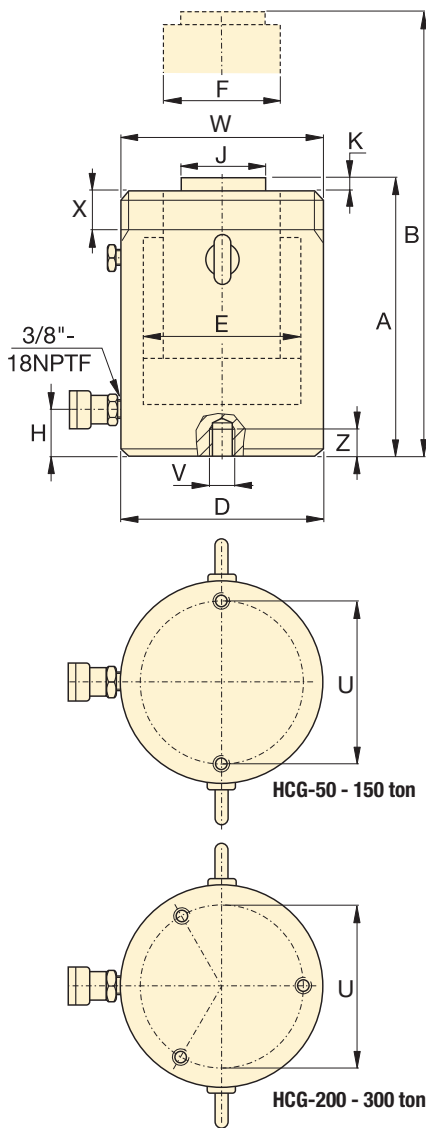

## HCG-Series, Single-Acting, Gravity-Return Cylinders

- Hardened surface resists side-loading and cyclic wear
- Designed to withstand up to 10% side-load of maximum capacity 1)
- Stop-ring to prevent plunger blow-out
- Weather protected, inside and out
- Upper and lower replaceable bearings enclose the cylinder plunger for support throughout the stroke
- Certified lifting eyes, base mounting holes and collar threads

### SELECTION CHART 50 – 300-TON HCG-MODELS

For 400 – 1000-ton models, see pages 42-43.

For full product features see pages 36-37.

Cylinder Capacity (ton)	Stroke (in)	Model Number	Maximum Cylinder Capacity at 10,150 psi (ton)	Cylinder Effective Area (in <sup>2</sup> )	Oil Capacity (in <sup>3</sup> )	Collapsed Height A (in)
50	1.97	HCG-502	62	12.17	23.96	7.20
	3.94	HCG-504			47.93	9.17
	5.91	HCG-506 1)			71.89	11.14
	7.87	HCG-508			95.86	13.62
	9.84	HCG-5010			119.82	15.59
	11.81	HCG-5012 1)			143.78	17.56
100	1.97	HCG-1002	113	22.19	43.67	7.95
	3.94	HCG-1004			87.35	9.92
	5.91	HCG-1006			131.02	11.89
	7.87	HCG-1008			174.70	14.92
	9.84	HCG-10010			218.37	16.89
	11.81	HCG-10012			262.05	18.86
150	1.97	HCG-1502	168	33.14	65.24	8.66
	3.94	HCG-1504			130.48	10.63
	5.91	HCG-1506			195.73	12.60
	7.87	HCG-1508			260.97	15.63
	9.84	HCG-15010			326.21	17.60
	11.81	HCG-15012			391.45	19.57
200	1.97	HCG-2002	223	43.95	86.51	9.09
	3.94	HCG-2004			173.02	11.06
	5.91	HCG-2006			259.53	13.03
	7.87	HCG-2008			346.04	16.06
	9.84	HCG-20010			432.55	18.03
	11.81	HCG-20012			519.06	20.00
250	1.97	HCG-2502	286	56.27	110.77	9.49
	3.94	HCG-2504			221.55	11.46
	5.91	HCG-2506			332.32	13.43
	7.87	HCG-2508			443.09	16.97
	9.84	HCG-25010			553.87	18.94
	11.81	HCG-25012			664.64	20.91
300	1.97	HCG-3002	341	67.23	132.34	11.65
	3.94	HCG-3004			264.68	13.62
	5.91	HCG-3006			397.02	15.59
	7.87	HCG-3008			529.36	17.56
	9.84	HCG-30010			661.71	19.53
	11.81	HCG-30012			794.05	21.50

Collar Thread (in)		
Model / Capacity (ton)	Thread Size W	Thread Length X
HCG-50	M130 x 2	1.18
HCG-100	M175 x 3	1.81
HCG-150	M215 x 3	2.17
HCG-200	M250 x 3	2.48
HCG-250	M280 x 3	2.52
HCG-300	M305 x 3	2.87

The collar thread length is designed for the full rated cylinder capacity.

Base Mounting Holes (in)					
Model / Capacity (ton)	Bolt Circle U	Thread Size V	Minimum Thread Depth Z	Number of Holes	Angle from Coupler
HCG-50	4.13	M12 x 1,75	0.87	2	90°
HCG-100	5.91	M12 x 1,75	0.87	2	90°
HCG-150	7.28	M12 x 1,75	0.87	2	90°
HCG-200	8.46	M12 x 1,75	0.87	3	60°
HCG-250	9.65	M12 x 1,75	0.87	3	60°
HCG-300	10.24	M16 x 2	0.98	3	60°

1) HCG-506 and HCG-5012: 7% side-load of maximum capacity.

# Single-Acting, High-Tonnage Cylinders

Capacity:  
**50 - 300 ton**

Stroke:  
**1.97 - 11.81 inch**

Maximum Operating Pressure:  
**10,150 psi**

**HCG Series**

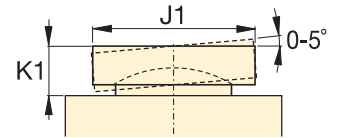

CATG-Series Tilt Saddle

	Extended Height	Outside Diameter	Cylinder Bore Diameter	Plunger Diameter	Base to Advance Port	Standard Saddle Diameter	Saddle Protusion from Plunger	Wt.	Model Number
	B (in)	D (in)	E (in)	F (in)	H (in)	J (in)	K (in)	(lbs)	
	9.17	5.12	3.94	2.76	1.50	1.97	0.12	37	HCG-502
	13.11							45	HCG-504
	17.05							53	HCG-506 <sup>1)</sup>
	21.50							64	HCG-508
	25.43							72	HCG-5010
	29.37							80	HCG-5012 <sup>1)</sup>
	9.92	6.89	5.31	3.74	1.50	2.95	0.12	73	HCG-1002
	13.86							88	HCG-1004
	17.80							102	HCG-1006
	22.80							128	HCG-1008
	26.73							142	HCG-10010
	30.67							157	HCG-10012 <sup>1)</sup>
	10.63	8.46	6.50	4.72	1.61	3.70	0.12	123	HCG-1502
	14.57							145	HCG-1504
	18.50							168	HCG-1506
	23.50							207	HCG-1508
	27.44							230	HCG-15010
	31.38							253	HCG-15012
	11.06	9.84	7.48	5.51	1.85	4.45	0.12	178	HCG-2002
	15.00							209	HCG-2004
	18.94							240	HCG-2006
	23.94							300	HCG-2008
	27.87							331	HCG-20010
	31.81							363	HCG-20012
	11.46	11.02	8.46	6.69	2.09	5.71	0.16	235	HCG-2502
	15.39							277	HCG-2504
	19.33							318	HCG-2506
	24.84							401	HCG-2508
	28.78							442	HCG-25010
	32.72							484	HCG-25012
	13.62	12.01	9.25	7.87	2.28	6.97	0.16	348	HCG-3002
	17.56							401	HCG-3004
	21.50							454	HCG-3006
	25.43							507	HCG-3008
	29.37							560	HCG-30010
	33.31							613	HCG-30012

Optional Tilt Saddle		
Diameter	Height	Saddle Model Number
J1 (in)	K1 (in)	
1.97	0.94	CATG-50
2.87	1.14	CATG-100
3.57	1.22	CATG-150
4.64	1.37	CATG-200
5.67	1.85	CATG-250
6.30	2.51	CATG-300

## HCG-Series, Single-Acting, Gravity-Return Cylinders

- Hardened surface resists side-loading and cyclic wear
- Designed to withstand up to 10% side-load of maximum capacity
- Stop-ring to prevent plunger blow-out
- Weather protected, inside and out
- Upper and lower replaceable bearings enclose the cylinder plunger for support throughout the stroke
- Certified lifting eyes, base mounting holes and collar threads

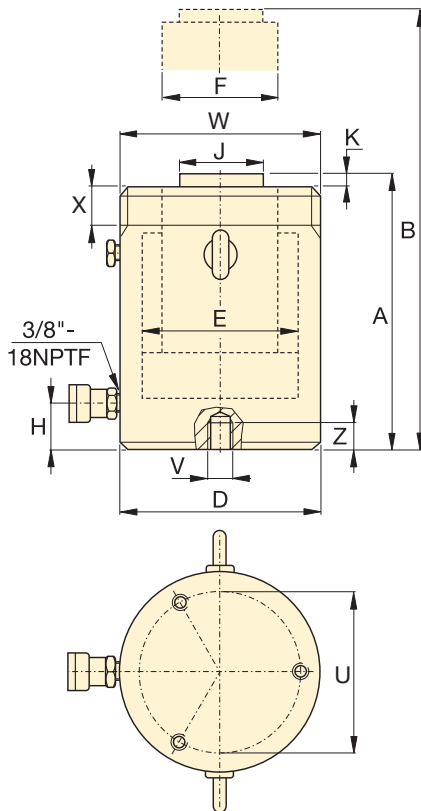

### SELECTION CHART 400 – 1000-TON HCG-MODELS

For 50 – 300-ton models, see pages 40-41.

For full product features see pages 36-37.

Cylinder Capacity (ton)	Stroke (in)	Model Number	Maximum Cylinder Capacity at 10,150 psi (ton)	Cylinder Effective Area (in <sup>2</sup> )	Oil Capacity (in <sup>3</sup> )	Collapsed Height A (in)
400	1.97	HCG-4002	450	88.75	174.70	12.64
	3.94	HCG-4004			349.39	14.61
	5.91	HCG-4006			524.09	16.57
	7.87	HCG-4008			698.79	18.54
	9.84	HCG-40010			873.49	20.51
	11.81	HCG-40012			1,048.18	22.48
500	1.97	HCG-5002	575	113.25	222.92	13.54
	3.94	HCG-5004			445.85	15.51
	5.91	HCG-5006			668.77	17.48
	7.87	HCG-5008			891.70	19.45
	9.84	HCG-50010			1,114.62	21.42
	11.81	HCG-50012			1,337.55	23.39
600	1.97	HCG-6002	673	132.57	260.97	13.86
	3.94	HCG-6004			521.94	15.83
	5.91	HCG-6006			782.90	17.80
	7.87	HCG-6008			1,043.87	19.76
	9.84	HCG-60010			1,304.84	21.73
	11.81	HCG-60012			1,565.81	23.70
800	1.97	HCG-8002	916	180.44	355.21	15.91
	3.94	HCG-8004			710.41	17.87
	5.91	HCG-8006			1,065.62	19.84
	7.87	HCG-8008			1,420.82	21.81
	9.84	HCG-80010			1,776.03	23.78
	11.81	HCG-80012			2,131.24	25.75
1000	1.97	HCG-10002	1196	235.68	463.94	17.40
	3.94	HCG-10004			927.88	19.37
	5.91	HCG-10006			1,391.83	21.34
	7.87	HCG-10008			1,855.77	23.31
	9.84	HCG-100010			2,319.71	25.28
	11.81	HCG-100012			2,783.65	27.24

Collar Thread (in)		
Model / Capacity (ton)	Thread Size W	Thread Length X
HCG-400	M350 x 3	3.27
HCG-500	M400 x 4	3.54
HCG-600	M430 x 4	3.94
HCG-800	M505 x 5	4.80
HCG-1000	M570 x 5	5.39

The collar thread length is designed for the full rated cylinder capacity.

Base Mounting Holes (in)					
Model / Capacity (ton)	Bolt Circle U	Thread Size V	Minimum Thread Depth Z	Number of Holes	Angle from Coupler
HCG-400	11.81	M16 x 2	0.98	3	60°
HCG-500	13.39	M24 x 3	1.42	3	60°
HCG-600	14.57	M24 x 3	1.42	3	60°
HCG-800	17.32	M24 x 3	1.42	3	60°
HCG-1000	19.69	M24 x 3	1.42	3	60°

# Single-Acting, High-Tonnage Cylinders



▲ Offshore wind turbine leveling: Enerpac's synchronous lifting system was the solution for leveling support cross pieces on 80 wind turbines.

## HCG Series



Capacity:  
**400 - 1000 ton**

Stroke:  
**1.97 - 11.81 inch**

Maximum Operating Pressure:  
**10,150 psi**

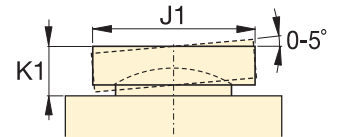

CATG-Series Tilt Saddle

Extended Height	Outside Diameter	Cylinder Bore Diameter	Plunger Diameter	Base to Advance Port	Standard Saddle Diameter	Saddle Protrusion from Plunger	Wt.	Model Number
B (in)	D (in)	E (in)	F (in)	H (in)	J (in)	K (in)	(lbs)	
14.61	13.78	10.63	8.66	2.91	7.72	0.16	500	HCG-4002
18.54							566	HCG-4004
22.48							633	HCG-4006
26.42							699	HCG-4008
30.35							766	HCG-40010
34.29							833	HCG-40012
15.51	15.75	12.01	9.84	3.11	8.98	0.16	704	HCG-5002
19.45							792	HCG-5004
23.39							880	HCG-5006
27.32							968	HCG-5008
31.26							1,056	HCG-50010
35.20							1,144	HCG-50012
15.83	16.93	12.99	10.63	3.35	9.72	0.16	834	HCG-6002
19.76							935	HCG-6004
23.70							1,036	HCG-6006
27.64							1,137	HCG-6008
31.57							1,239	HCG-60010
35.51							1,340	HCG-60012
17.87	19.88	15.16	12.60	3.94	11.69	0.16	1,336	HCG-8002
21.81							1,479	HCG-8004
25.75							1,621	HCG-8006
29.69							1,763	HCG-8008
33.62							1,905	HCG-80010
37.56							2,047	HCG-80012
19.37	22.44	17.32	13.39	4.49	12.72	0.16	1,852	HCG-10002
23.31							2,020	HCG-10004
27.24							2,188	HCG-10006
31.18							2,355	HCG-10008
35.12							2,523	HCG-100010
39.06							2,691	HCG-100012

Optional Tilt Saddle		
Diameter	Height	Saddle Model Number
J1 (in)	K1 (in)	
7.59	2.32	CATG-400
8.98	2.48	CATG-500
9.47	3.08	CATG-600
11.28	3.41	CATG-800
12.26	3.65	CATG-1000



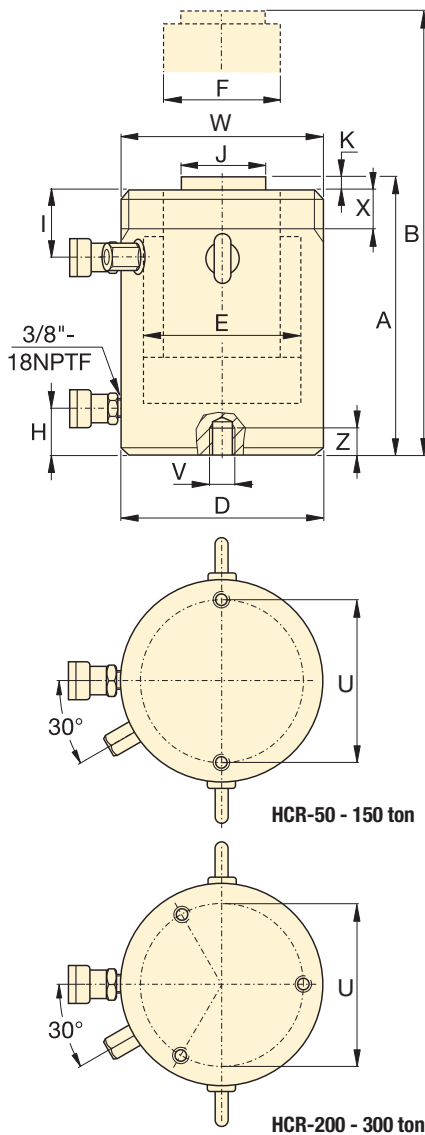

## HCR-Series, Double-Acting Cylinders

- Fast advance and retract
- Designed to withstand up to 10% side-load of maximum capacity 1)
- Hardened surface resists side-loading and cyclic wear
- Weather protected, inside and out
- Upper and lower replaceable bearings enclose the cylinder plunger for support throughout the stroke
- Certified lifting eyes, base mounting holes and collar threads

### SELECTION CHART AND DETAILS OF 50 – 300-TON HCR-MODELS

For 400 – 1000-ton models, see pages 46-47.

For full product features see pages 36-37

Cylinder Capacity (ton)	Stroke (in)	Model Number	Maximum Cylinder Capacity at 10,150 psi (ton)	Cylinder Effective Area (in <sup>2</sup> )	Oil Capacity (in <sup>3</sup> )	Collapsed Height A (in)
50	1.97	HCR-502	62	12.17	23.96	7.20
	3.94	HCR-504			47.93	9.17
	5.91	HCR-506 1)			71.89	11.14
	7.87	HCR-508			95.86	13.62
	9.84	HCR-5010			119.82	15.59
	11.81	HCR-5012 1)			143.78	17.56
100	1.97	HCR-1002	113	22.19	43.67	7.95
	3.94	HCR-1004			87.35	9.92
	5.91	HCR-1006			131.02	11.89
	7.87	HCR-1008			174.70	14.92
	9.84	HCR-10010			218.37	16.89
	11.81	HCR-10012			262.05	18.86
150	1.97	HCR-1502	168	33.14	65.24	8.66
	3.94	HCR-1504			130.48	10.63
	5.91	HCR-1506			195.73	12.60
	7.87	HCR-1508			260.97	15.63
	9.84	HCR-15010			326.21	17.60
	11.81	HCR-15012			391.45	19.57
200	1.97	HCR-2002	223	43.95	86.51	9.09
	3.94	HCR-2004			173.02	11.06
	5.91	HCR-2006			259.53	13.03
	7.87	HCR-2008			346.04	16.06
	9.84	HCR-20010			432.55	18.03
	11.81	HCR-20012			519.06	20.00
250	1.97	HCR-2502	286	56.27	110.77	9.49
	3.94	HCR-2504			221.55	11.46
	5.91	HCR-2506			332.32	13.43
	7.87	HCR-2508			443.09	16.97
	9.84	HCR-25010			553.87	18.94
	11.81	HCR-25012			664.64	20.91
300	1.97	HCR-3002	341	67.23	132.34	11.65
	3.94	HCR-3004			264.68	13.62
	5.91	HCR-3006			397.02	15.59
	7.87	HCR-3008			529.36	17.56
	9.84	HCR-30010			661.71	19.53
	11.81	HCR-30012			794.05	21.50

Collar Thread (in)		
Model / Capacity (ton)	Thread Size W	Thread Length X
HCR-50	M130 x 2	1.18
HCR-100	M175 x 3	1.81
HCR-150	M215 x 3	2.17
HCR-200	M250 x 3	2.48
HCR-250	M280 x 3	2.52
HCR-300	M305 x 3	2.87

The collar thread length is designed for the full rated cylinder capacity.

Base Mounting Holes (in)					
Model / Capacity (ton)	Bolt Circle U	Thread Size V	Minimum Thread Depth Z	No. of Holes	Angle from Coupler
HCR-50	4.13	M12 x 1,75	0.87	2	90°
HCR-100	5.91	M12 x 1,75	0.87	2	90°
HCR-150	7.28	M12 x 1,75	0.87	2	90°
HCR-200	8.46	M12 x 1,75	0.87	3	60°
HCR-250	9.65	M12 x 1,75	0.87	3	60°
HCR-300	10.24	M16 x 2	0.98	3	60°

1) HCR-506 and HCR-5012: 7% side-load of maximum capacity.

# Double-Acting, High-Tonnage Cylinders

Capacity:  
**50 - 300 ton**

Stroke:  
**1.97 - 11.81 inch**

Maximum Operating Pressure:  
**10,150 psi**

**HCR**  
Series

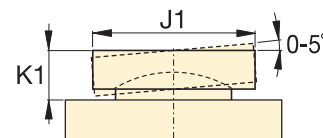

CATG-Series Tilt Saddle

	Extended Height	Outside Diameter	Cylinder Bore Diameter	Plunger Diameter	Base to Advance Port	Top to Retract Port	Standard Saddle Diameter	Saddle Protrusion from Plunger	Wt.	Model Number
	B (in)	D (in)	E (in)	F (in)	H (in)	I (in)	J (in)	K (in)	(lbs)	
	9.17	5.12	3.94	2.76	1.50	1.77	1.97	0.12	37	HCR-502
	13.11								46	HCR-504
	17.05								54	HCR-506 <sup>1)</sup>
	21.50					2.17			68	HCR-508
	25.43								76	HCR-5010
	29.37								84	HCR-5012 <sup>1)</sup>
	9.92	6.89	5.31	3.74	1.50	2.56	2.95	0.12	74	HCR-1002
	13.86								90	HCR-1004
	17.80								105	HCR-1006
	22.80					3.15			131	HCR-1008
	26.73								146	HCR-10010
	30.67								161	HCR-10012
	10.63	8.46	6.50	4.72	1.61	2.76	3.70	0.12	124	HCR-1502
	14.57								148	HCR-1504
	18.50								172	HCR-1506
	23.50					3.54			209	HCR-1508
	27.44								233	HCR-15010
	31.38								257	HCR-15012
	11.06	9.84	7.48	5.51	1.85	3.11	4.45	0.12	179	HCR-2002
	15.00								212	HCR-2004
	18.94								244	HCR-2006
	23.94					3.82			306	HCR-2008
	27.87								338	HCR-20010
	31.81								371	HCR-20012
	11.46	11.02	8.46	6.69	2.09	3.11	5.71	0.16	236	HCR-2502
	15.39								279	HCR-2504
	19.33								322	HCR-2506
	24.84					4.09			407	HCR-2508
	28.78								457	HCR-25010
	32.72								500	HCR-25012
	13.62	12.01	9.25	7.87	2.28	3.98	6.97	0.16	350	HCR-3002
	17.56								404	HCR-3004
	21.50								458	HCR-3006
	25.43					5.12			512	HCR-3008
	29.37								566	HCR-30010
	33.31								620	HCR-30012

Optional Tilt Saddle		
Diameter	Height	Saddle Model Number
J1 (in)	K1 (in)	
1.97	0.94	CATG-50
2.87	1.14	CATG-100
3.57	1.22	CATG-150
4.64	1.37	CATG-200
5.67	1.85	CATG-250
6.30	2.51	CATG-300

## HCR-Series, Double-Acting Cylinders

- Fast advance and retract
- Designed to withstand up to 10% side-load of maximum capacity
- Hardened surface resists side-loading and cyclic wear
- Weather protected, inside and out
- Upper and lower replaceable bearings enclose the cylinder plunger for support throughout the stroke
- Certified lifting eyes, base mounting holes and collar threads

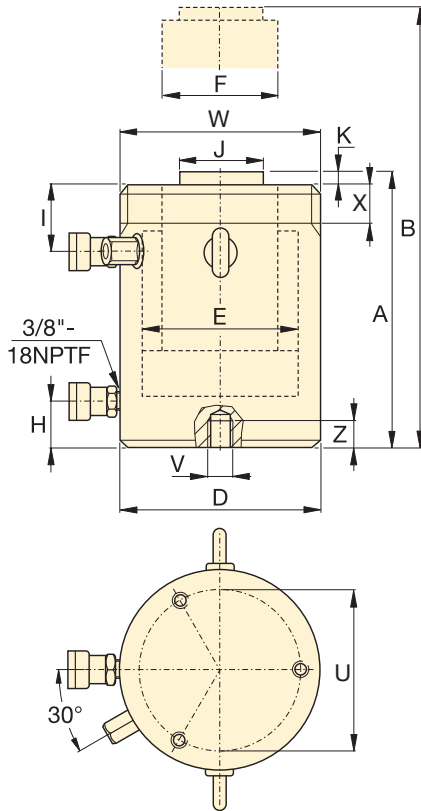

### SELECTION CHART AND DETAILS OF 400 – 1000-TON HCR-MODELS

For 50 – 300-ton models, see pages 44-45.

For full product features see pages 36-37.

Cylinder Capacity (ton)	Stroke (in)	Model Number	Maximum Cylinder Capacity at 10, 150 psi (ton)	Cylinder Effective Area (in <sup>2</sup> )	Oil Capacity (in <sup>3</sup> )	Collapsed Height A (in)
400	1.97	HCR-4002	450	88.75	174.70	12.64
	3.94	HCR-4004			349.39	14.61
	5.91	HCR-4006			524.09	16.57
	7.87	HCR-4008			698.79	18.54
	9.84	HCR-40010			873.49	20.51
	11.81	HCR-40012			1,048.18	22.48
500	1.97	HCR-5002	575	113.25	222.92	13.54
	3.94	HCR-5004			445.85	15.51
	5.91	HCR-5006			668.77	17.48
	7.87	HCR-5008			891.70	19.45
	9.84	HCR-50010			1,114.62	21.42
	11.81	HCR-50012			1,337.55	23.39
600	1.97	HCR-6002	673	132.57	260.97	13.86
	3.94	HCR-6004			521.94	15.83
	5.91	HCR-6006			782.90	17.80
	7.87	HCR-6008			1,043.87	19.76
	9.84	HCR-60010			1,304.84	21.73
	11.81	HCR-60012			1,565.81	23.70
800	1.97	HCR-8002	916	180.44	355.21	15.91
	3.94	HCR-8004			710.41	17.87
	5.91	HCR-8006			1,065.62	19.84
	7.87	HCR-8008			1,420.82	21.81
	9.84	HCR-80010			1,776.03	23.78
	11.81	HCR-80012			2,131.24	25.75
1000	1.97	HCR-10002	1196	235.68	463.94	17.40
	3.94	HCR-10004			927.88	19.37
	5.91	HCR-10006			1,391.83	21.34
	7.87	HCR-10008			1,855.77	23.31
	9.84	HCR-100010			2,319.71	25.28
	11.81	HCR-100012			2,783.65	27.24

Collar Thread (in)		
Model / Capacity (ton)	Thread Size W	Thread Length X
HCR-400	M350 x 3	3.27
HCR-500	M400 x 4	3.54
HCR-600	M430 x 4	3.94
HCR-800	M505 x 5	4.80
HCR-1000	M570 x 5	5.39

The collar thread length is designed for the full rated cylinder capacity.

Base Mounting Holes (in)					
Model / Capacity (ton)	Bolt Circle U	Thread Size V	Min. Thread Depth Z	Number of Holes	Angle from Coupler
HCR-400	11.81	M16 x 2	0.98	3	60°
HCR-500	13.39	M24 x 3	1.42	3	60°
HCR-600	14.57	M24 x 3	1.42	3	60°
HCR-800	17.32	M24 x 3	1.42	3	60°
HCR-1000	19.69	M24 x 3	1.42	3	60°

# Double-Acting, High-Tonnage Cylinders



▲ The superlifting and launch of a 43,000 ton floating oil production system in Malaysia for the Gumusut-Kakap offshore field has set high benchmarks for safety through its use of sophisticated EVO-Series synchronous hydraulics to lift, balance, weigh and smoothly launch massive resource structures.

## HCR Series



Capacity:  
**400 - 1000 ton**

Stroke:  
**1.97 - 11.81 inch**

Maximum Operating Pressure:  
**10,150 psi**

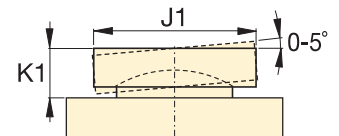

CATG-Series Tilt Saddle

Extended Height	Outside Diameter	Cylinder Bore Diameter	Plunger Diameter	Base to Advance Port	Top to Retract Port	Standard Saddle Diameter	Saddle Protrusion from Plunger	Wt. (lbs)	Model Number	Optional Tilt Saddle			
										Diameter J1 (in)	Height K1 (in)	Saddle Model Number	
14.61	13.78	10.63	8.66	2.91	4.37	7.72	0.16	501	HCR-4002	7.59	2.32	CATG-400	
18.54								570					HCR-4004
22.48								638					HCR-4006
26.42								707					HCR-4008
30.35								775					HCR-40010
34.29								843					HCR-40012
15.51	15.75	12.01	9.84	3.11	4.76	8.98	0.16	706	HCR-5002	8.98	2.48	CATG-500	
19.45								797					HCR-5004
23.39								887					HCR-5006
27.32								977					HCR-5008
31.26								1,067					HCR-50010
35.20								1,158					HCR-50012
15.83	16.93	12.99	10.63	3.35	4.76	9.72	0.16	836	HCR-6002	9.47	3.08	CATG-600	
19.76								940					HCR-6004
23.70								1,044					HCR-6006
27.64								1,148					HCR-6008
31.57								1,252					HCR-60010
35.51								1,356					HCR-60012
17.87	19.88	15.16	12.60	3.94	5.63	11.69	0.16	1,340	HCR-8002	11.28	3.41	CATG-800	
21.81								1,485					HCR-8004
25.75								1,631					HCR-8006
29.69								1,777					HCR-8008
33.62								1,922					HCR-80010
37.56								2,068					HCR-80012
19.37	22.44	17.32	13.39	4.49	6.02	12.72	0.16	1,858	HCR-10002	12.26	3.65	CATG-1000	
23.31								2,031					HCR-10004
27.24								2,205					HCR-10006
31.18								2,379					HCR-10008
35.12								2,552					HCR-100010
39.06								2,726					HCR-100012

## HCL-Series, Single-Acting, Gravity-Return Cylinders

- Lock nut provides positive and safe mechanical load holding
- Low-friction locking rings spin easy, save time and effort
- Designed to withstand 10% side-load up to 90% of maximum stroke
- Hardened surface resists side-loading and cyclic wear
- Overflow port as stroke limiter to prevent plunger blow-out
- Weather protected, inside and out
- Replaceable bearings enclose the plunger for support throughout the stroke
- Certified lifting eyes and base mounting holes

### SELECTION CHART 50 – 300-TON HCL-MODELS

For 400 – 1000-ton models, see pages 50-51.

For full product features see pages 36-37.

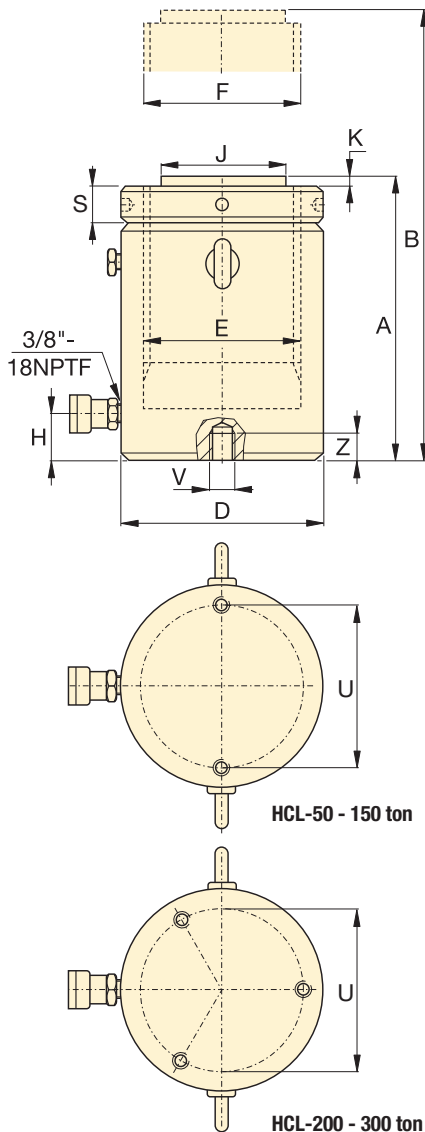

Base Mounting Holes (in)					
Model / Capacity (ton)	Bolt Circle U	Thread Size V	Minimum Thread Depth Z	Number of Holes	Angle from Coupler
HCL-50	4.13	M8X1.25	0.39	2	90°
HCL-100	5.91	M12X1.75	0.67	2	90°
HCL-150	7.28	M12X1.75	0.87	2	90°
HCL-200	8.46	M12X1.75	0.87	3	60°
HCL-250	9.65	M12X1.75	0.87	3	60°
HCL-300	10.24	M16X2	0.98	3	60°

Cylinder Capacity (ton)	Stroke (in)	Model Number	Maximum Cylinder Capacity at 10,150 psi (ton)	Cylinder Effective Area (in <sup>2</sup> )	Oil Capacity (in <sup>3</sup> )	Collapsed Height A (in)
50	1.97	HCL-502	62	12.17	23.96	6.46
	3.94	HCL-504			47.93	8.43
	5.91	HCL-506			71.89	10.39
	7.87	HCL-508			95.86	12.36
	9.84	HCL-5010			119.82	14.33
	11.81	HCL-5012			143.78	16.30
100	1.97	HCL-1002	113	22.19	43.67	7.36
	3.94	HCL-1004			87.35	9.33
	5.91	HCL-1006			131.02	11.30
	7.87	HCL-1008			174.70	13.27
	9.84	HCL-10010			218.37	15.24
	11.81	HCL-10012			262.05	17.20
150	1.97	HCL-1502	168	33.14	65.24	8.23
	3.94	HCL-1504			130.48	10.20
	5.91	HCL-1506			195.73	12.17
	7.87	HCL-1508			260.97	14.13
	9.84	HCL-15010			326.21	16.10
	11.81	HCL-15012			391.45	18.07
200	1.97	HCL-2002	223	43.95	86.51	9.37
	3.94	HCL-2004			173.02	11.34
	5.91	HCL-2006			259.53	13.31
	7.87	HCL-2008			346.04	15.28
	9.84	HCL-20010			432.55	17.24
	11.81	HCL-20012			519.06	19.21
250	1.97	HCL-2502	286	56.27	110.77	9.80
	3.94	HCL-2504			221.55	11.77
	5.91	HCL-2506			332.32	13.74
	7.87	HCL-2508			443.09	15.71
	9.84	HCL-25010			553.87	17.68
	11.81	HCL-25012			664.64	19.65
300	1.97	HCL-3002	341	67.23	132.34	10.94
	3.94	HCL-3004			264.68	12.91
	5.91	HCL-3006			397.02	14.88
	7.87	HCL-3008			529.36	16.85
	9.84	HCL-30010			661.71	18.82
	11.81	HCL-30012			794.05	20.79

# Single-Acting, High-Tonnage Lock Nut Cylinders

Capacity:  
**50 - 300 ton**

Stroke:  
**1.97 - 11.81 inch**

Maximum Operating Pressure:  
**10,150 psi**

**HCL Series**

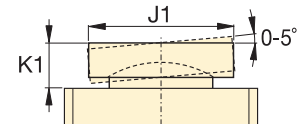

**CAT-Series Tilt Saddle**

Extended Height	Outside Diameter	Cylinder Bore Diameter	Plunger Diameter	Base to Advance Port	Standard Saddle Diameter	Saddle Protrusion from Plunger K (in)	Lock Nut Height	Wt. (lbs)	Model Number	Optional Tilt Saddle		
										Diameter J1 (in)	Height K1 (in)	Saddle Model Number
8.43	5.12	3.94	Tr 100 x 4	0.94	2.80	0.08	0.98	37	HCL-502	2.80	0.93	CAT-100
12.36								48	HCL-504			
16.30								60	HCL-506			
20.24								71	HCL-508			
24.17								83	HCL-5010			
28.11								94	HCL-5012			
9.33	6.89	5.31	Tr 135 x 6	1.30	2.80	0.08	1.30	77	HCL-1002	2.80	0.93	CAT-100
13.27								98	HCL-1004			
17.20								118	HCL-1006			
21.14								139	HCL-1008			
25.08								160	HCL-10010			
29.02								181	HCL-10012			
10.20	8.46	6.50	Tr 165 x 6	1.61	5.12	0.08	1.57	130	HCL-1502	5.12	0.76	CAT-200
14.13								161	HCL-1504			
18.07								192	HCL-1506			
22.01								224	HCL-1508			
25.94								255	HCL-15010			
29.88								287	HCL-15012			
11.34	9.84	7.48	Tr 190 x 6	1.85	5.12	0.08	1.77	188	HCL-2002	5.12	0.76	CAT-200
15.28								231	HCL-2004			
19.21								273	HCL-2006			
23.15								316	HCL-2008			
27.09								358	HCL-20010			
31.02								401	HCL-20012			
11.77	11.02	8.46	Tr 215 x 6	2.09	5.91	0.08	2.05	262	HCL-2502	5.91	0.76	CAT-250
15.71								316	HCL-2504			
19.65								369	HCL-2506			
23.58								422	HCL-2508			
27.52								476	HCL-25010			
31.46								529	HCL-25012			
12.91	12.01	9.25	Tr 235 x 6	2.28	5.49	0.08	2.20	348	HCL-3002	7.68	2.86	CAT-300
16.85								411	HCL-3004			
20.79								474	HCL-3006			
24.72								537	HCL-3008			
28.66								601	HCL-30010			
32.60								664	HCL-30012			

## HCL-Series, Single-Acting, Gravity-Return Cylinders

- Lock nut provides positive and safe mechanical load holding
- Low-friction locking rings spin easy, save time and effort
- Designed to withstand 10% side-load up to 90% of maximum stroke
- Hardened surface resists side-loading and cyclic wear
- Overflow port as stroke limiter to prevent plunger blow-out
- Weather protected, inside and out
- Replaceable bearings enclose the plunger for support throughout the stroke
- Certified lifting eyes and base mounting holes

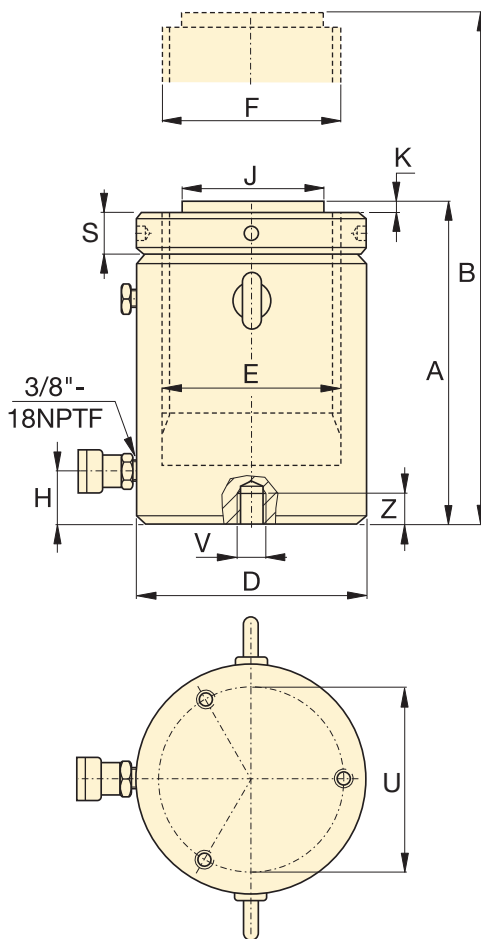

### SELECTION CHART 400 – 1000-TON HCL-MODELS

For 50 – 300-ton models, see pages 48-49

For full product features see pages 36-37.

Cylinder Capacity (ton)	Stroke (in)	Model Number	Maximum Cylinder Capacity at 10,150 psi (ton)	Cylinder Effective Area (in <sup>2</sup> )	Oil Capacity (in <sup>3</sup> )	Collapsed Height A (in)
400	1.97	HCL-4002	450	88.75	174.70	12.48
	3.94	HCL-4004			349.39	14.45
	5.91	HCL-4006			524.09	16.42
	7.87	HCL-4008			698.79	18.39
	9.84	HCL-40010			873.49	20.35
	11.81	HCL-40012			1,048.18	22.32
500	1.97	HCL-5002	575	113.25	222.92	14.06
	3.94	HCL-5004			445.85	16.02
	5.91	HCL-5006			668.77	17.99
	7.87	HCL-5008			891.70	19.96
	9.84	HCL-50010			1,114.62	21.93
	11.81	HCL-50012			1,337.55	23.90
600	1.97	HCL-6002	673	132.57	260.97	14.96
	3.94	HCL-6004			521.94	16.93
	5.91	HCL-6006			782.90	18.90
	7.87	HCL-6008			1,043.87	20.87
	9.84	HCL-60010			1,304.84	22.83
	11.81	HCL-60012			1,565.81	24.80
800	1.97	HCL-8002	916	180.44	355.21	16.93
	3.94	HCL-8004			710.41	18.90
	5.91	HCL-8006			1,065.62	20.87
	7.87	HCL-8008			1,420.82	22.83
	9.84	HCL-80010			1,776.03	24.80
	11.81	HCL-80012			2,131.24	26.77
1000	1.97	HCL-10002	1196	235.68	463.94	19.06
	3.94	HCL-10004			927.88	21.02
	5.91	HCL-10006			1,391.83	22.99
	7.87	HCL-10008			1,855.77	24.96
	9.84	HCL-100010			2,319.71	26.93
	11.81	HCL-100012			2,783.65	28.90

Base Mounting Holes (in)					
Model / Capacity (ton)	Bolt Circle U	Thread Size V	Minimum Thread Depth Z	Number of Holes	Angle from Coupler
HCL-400	11.81	M16 x 2	0.95	3	60°
HCL-500	13.39	M24 x 3	1.42	3	60°
HCL-600	14.57	M24 x 3	1.42	3	60°
HCL-800	17.32	M24 x 3	1.42	3	60°
HCL-1000	19.69	M24 x 3	1.42	3	60°

# Single-Acting, High Tonnage, Lock Nut Cylinders



▲ Heavy lifting and foundation levelling. The lock nut provides mechanical load holding over a long period of time.

## HCL Series



Capacity:  
**400 - 1000 ton**

Stroke:  
**1.97 - 11.81 inch**

Maximum Operating Pressure:  
**10,150 psi**

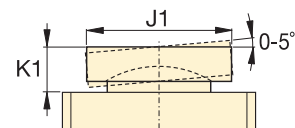

CAT-Series Tilt Saddle

Extended Height	Outside Diameter	Cylinder Bore Diameter	Plunger Diameter	Base to Advance Port	Standard Saddle Diameter	Saddle Protrusion from Plunger	Lock Nut Height	Wt.	Model Number	Optional Tilt Saddle		
										Diameter	Height	Saddle Model Number
B (in)	D (in)	E (in)	F (mm)	H (in)	J (in)	K (in)	S (in)	(lbs)		J1 (in)	K1 (in)	
14.45	13.78	10.63	Tr 270 x 6	2.64	6.27	0.20	2.56	520	HCL-4002	8.86	3.34	CAT-400
18.39								603	HCL-4004			
22.32								686	HCL-4006			
26.26								770	HCL-4008			
30.20								853	HCL-40010			
34.13								936	HCL-40012			
16.02	15.75	12.01	Tr 305 x 6	2.95	7.06	0.20	2.83	751	HCL-5002	9.84	3.57	CAT-500
19.96								860	HCL-5004			
23.90								968	HCL-5006			
27.83								1,077	HCL-5008			
31.77								1,186	HCL-50010			
35.71								1,294	HCL-50012			
16.93	16.93	12.99	Tr 330 x 6	3.19	7.65	0.20	3.15	942	HCL-6002	10.83	3.89	CAT-600
20.87								1,067	HCL-6004			
24.80								1,193	HCL-6006			
28.74								1,319	HCL-6008			
32.68								1,444	HCL-60010			
36.61								1,570	HCL-60012			
18.90	19.88	15.16	Tr 385 x 6	3.74	8.83	0.20	3.54	1,472	HCL-8002	12.60	4.89	CAT-800
22.83								1,646	HCL-8004			
26.77								1,819	HCL-8006			
30.71								1,992	HCL-8008			
34.65								2,166	HCL-80010			
38.58								2,339	HCL-80012			
21.02	22.44	17.32	Tr 440 x 6	4.33	9.81	0.20	4.13	2,115	HCL-10002	14.17	5.36	CAT-1000
24.96								2,335	HCL-10004			
28.90								2,556	HCL-10006			
32.83								2,777	HCL-10008			
36.77								2,998	HCL-100010			
40.71								3,219	HCL-100012			



▼ Shown cylinder-pump set: SCR-1010H



## The Quickest and Easiest Way to Start Working Right Away



### LW-16 Lifting Wedge

Hydraulic cylinders, jacks and lifting wedges can also be used to assist in positioning and aligning.



The LW-16 only requires an access gap of .39 inch. See our "Specialty Tools" section on [www.enerpac.com](http://www.enerpac.com).

Page: 192

- Optimum match of individual components
- All sets are ready to use and include single-acting cylinder, two-speed pump, 6-foot safety hose, calibrated gauge with gauge adaptor
- RC-Series DUO, general purpose cylinders for maximum versatility
- RCS-Series, low-height cylinders for maximum versatility
- RCH-Series hollow cylinders for pushing and pulling

▼ Cylinder-Pump Sets - optimum match of components. The quickest and easiest way to start working right away.



1 Cylinder Selection	Nominal Set Capacity (ton)	Cylinder Model No.	Stroke (in)	Collapsed Height (in)
	5	RC-55	5.00	8.50
	10	RC-102	2.13	4.78
		RC-106	6.13	9.75
		RC-1010	10.13	13.75
	15	RC-154	4.00	7.88
		RC-156	6.00	10.69
25	RC-252	2.00	6.50	
	RC-254	4.00	8.50	
	RC-256	6.25	10.75	
	RC-2514	14.25	18.75	
50	RC-506	6.25	11.13	
	10	RCS-101	1.50	3.47
	20	RCS-201	1.75	3.88
	30	RCS-302	2.44	4.63
	50	RCS-502	2.38	4.81
	100	RCS-1002	2.25	5.56
	12	RCH-121	1.63	4.75
	20	RCH-202	2.00	6.31
	30	RCH-302	2.50	7.03
	60	RCH-603	3.00	9.75
	100	RCH-1003	3.00	10.00

# Single-Acting, Cylinder Pump Sets

## SELECTION EXAMPLE

### Selected cylinder:

- RC-106, Single-acting cylinder with 6.13" stroke

### Selected pump:

- P-392, Lightweight hand pump

### Set model number:

- SCR-106H

### Included:

- HC-7206 hose
- GF-10P gauge
- GA-2 adaptor



### GA45GC Gauge Adaptor<sup>3)</sup>

Protect yourself from system overloading by simply ordering one part number for a pre-assembled gauge, adaptor block and coupler.

Page: 144

## SC Series



Capacity:

**5-100 tons**

Stroke:

**1.50-14.25 inches**

Maximum Operating Pressure:

**10,000 psi**

## SET SELECTION:

- 1 Select the cylinder
- 2 Select the pump
- 3 Find the set model number in the gray field of the matrix

2

Pump selection (See Pump Section of this catalog for full product descriptions)

Accessories Included

Hand Pump P-142	Hand Pump P-392	Hand Pump P-80	Foot Pump P-392FP	XA-Series Air Pump XA-11	XC-Series Cordless Pump <sup>2)</sup> XC-1202MB	Hose Model No.	Gauge Model No.	Gauge Adaptor Model No.
SCR-55H	-	-	-	-	-	HC-7206	GP-10S	GA-4
-	SCR-102H	-	SCR-102FP	SCR-102XA	SCR-102XCB	HC-7206	GF-10P	GA-2
-	SCR-106H	-	SCR-106FP	SCR-106XA	SCR-106XCB	HC-7206	GF-10P	GA-2
-	SCR-1010H	-	SCR-1010FP	SCR-1010XA	SCR-1010XCB	HC-7206	GF-10P	GA-2
-	SCR-154H	-	SCR-154FP	SCR-154XA	SCR-154XCB	HC-7206	GP-10S	GA-2
-	SCR-156H	-	SCR-156FP	SCR-156XA	SCR-156XCB	HC-7206	GP-10S	GA-2
-	SCR-252H	-	SCR-252FP	SCR-252XA	SCR-252XCB	HC-7206	GF-20P	GA-2
-	SCR-254H	-	SCR-254FP	SCR-254XA	SCR-254XCB	HC-7206	GF-20P	GA-2
-	SCR-256H	-	-	SCR-256XA	SCR-256XCB	HC-7206	GF-20P	GA-2
-	-	SCR-2514H	-	SCR-2514XA <sup>1)</sup>	-	HC-7206	GF-20P	GA-2
-	-	SCR-506H	-	SCR-506XA <sup>1)</sup>	-	HC-7206	GF-50P	GA-2
-	SCL-101H	-	SCL-101FP	SCL-101XA	-	HC-7206	GF-10P	GA-2
-	SCL-201H	-	SCL-201FP	SCL-201XA	-	HC-7206	GF-230P	GA-2
-	SCL-302H	-	SCL-302FP	SCL-302XA	SCL-302XCB	HC-7206	GF-230P	GA-2
-	SCL-502H	-	SCL-502FP	SCL-502XA	SCL-502XCB	HC-7206	GF-510P	GA-2
-	-	SCL-1002H	-	-	SCL-1002XCB	HC-7206	GF-510P	GA-2
SCH-121H	-	-	-	-	-	HB-7206	GF-120P	GA-4
-	SCH-202H	-	SCH-202FP	SCH-202XA	SCH-202XCB	HC-7206	GF-813P	GA-3
-	SCH-302H	-	SCH-302FP	SCH-302XA	SCH-302XCB	HC-7206	GF-813P	GA-3
-	-	SCH-603H	-	SCH-603XA <sup>1)</sup>	SCH-603XCB	HC-7206	GF-813P	GA-3
-	-	SCH-1003H	-	-	-	HC-7206	GP-10S	GA-2

<sup>1)</sup> With XA-12 air pump

<sup>2)</sup> XC Cordless Pump includes 115 V charger, for 230 V charger replace the "B" in the model number with an "E".

<sup>3)</sup> XC Pump Sets include only the HC-7206 Hose and GA45GC Gauge Adaptor accessories

▼ Shown from left to right: P-142ALSS, P-392ALSS, V-152NV, V-66NV, RC256NV, RC-106NV, RC-53NV



## RC, P, V Series

Cylinder Capacity:  
**5-25 tons**

Stroke:  
**2-6 inches**

Maximum Operating Pressure:  
**10,000 psi**



### Applications

Use Enerpac **Extreme Environment Products** in wet environments such as food processing, pulp and paper, mining, construction and applications in high temperature or in welding areas.

- Corrosion resistant, nickel-plated valves and cylinders
- Stainless steel pump inserts will not corrode
- Viton® Seals provide heat and chemical resistance
- Anodized aluminum pump reservoirs and plastic encapsulated pump bodies resist wet environments
- Two-speed operation reduces pump handle strokes 78% compared to single-speed pumps
- Pump handles lock for easy carrying



### Multifluid Hand Pumps

**MP-Series** corrosion resistant hand pumps for low pressure filling and high pressure testing applications, suitable for a wide range of fluids.

Page: **77**

### ▼ CYLINDER CHART



Cylinder Capacity	Stroke	Model Number *	Oil Capacity	Pressure Rating	Collapsed Height	Extended Height	Outside Diameter	Weight
(ton)	(in)		(in <sup>3</sup> )	(psi)	(in)	(in)	(in)	(lbs)
5	3.0	RC-53NV	2.98	10,000	6.50	9.50	1.50	3.3
10	2.0	RC-102NV	4.75	10,000	4.78	6.91	2.25	5.1
10	6.0	RC-106NV	13.70	10,000	9.75	15.88	2.25	9.8
25	6.0	RC-256NV	32.23	10,000	10.75	17.00	3.38	22.0

### ▼ HAND PUMP CHART



Pump Type	Oil Capacity	Model Number *	Pressure Rating	Oil Displacement per Stroke	Port Dimension	Piston Stroke	Weight
	(in <sup>3</sup> )		(psi)	(in <sup>3</sup> )	(in)	(in)	(lbs)
Two Speed	20	P-142ALSS	200/10,000	0.221 / 0.055	1/4"-18 NPTF	.50	4.5
	55	P-392ALSS	200/10,000	0.687 / 0.151	3/8"-18 NPTF	1.00	9.0

### ▼ VALVE CHART



Valve Type	Model Number *	Pressure Function	Pressure Rating (psi)	Weight (lbs)
Manual Check Valve	V-66NV	Check	10,000	4.5
Pressure Relief Valve	V-152NV	+ 3% Repeatability	800-10,000	9.0

\* For cylinder details see pages 7-9; for pump details see pages 70-71; for valve details see pages 146-147.

# Portable Hydraulic Toolbox

▼ Shown: SCR106TB



- Includes a single-acting cylinder, two-speed lightweight hand pump (P392), gauge adaptor assembly (GA45GC), and 6 ft. rubber hose with couplers (HC9206C)
- Complete and ready-to-use hydraulic system
- Easy to carry sturdy toolbox
- All components ship inside the toolbox as one package

## SCR, SCL, SRS Series

Capacity:  
**5-50 tons**

Stroke:  
**.44- 10.13 inches**

Maximum Operating Pressure:  
**10,000 psi**







### Gauge Adaptor Assembly

Toolbox sets include a 45 degree angled gauge adaptor assembly for improved operating ergonomics and safety.

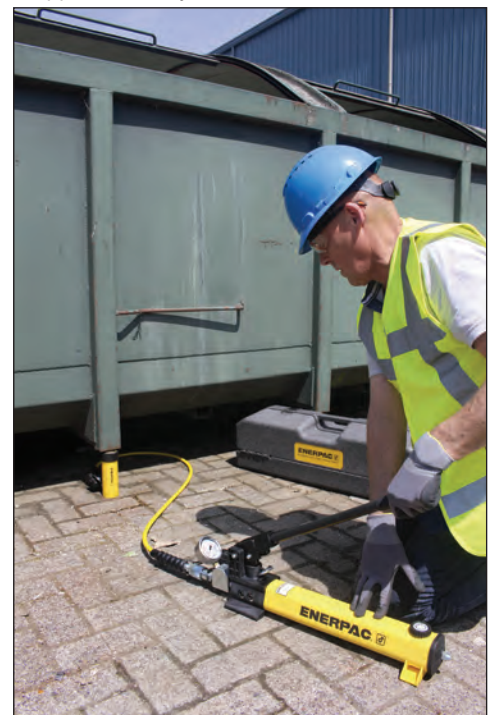
Page: 144

▼ The Hydraulic Toolbox is a versatile tool and applicable everywhere.



	Cylinder Model	Stroke (in)	Capacity (tons)	Weight (lbs)	Toolbox Set Model Number
 RC Series	<b>General Purpose Cylinders</b>				
	RC-55	5.00	5	26	SCR-55TB
	RC-102	2.13	10	27	SCR-102TB
	RC-106	6.13	10	32	SCR-106TB
	RC-1010	10.13	10	36	SCR-1010TB
	RC-154	4.00	15	34	SCR-154TB
	RC-256	6.25	25	45	SCR-256TB
 RCS Series	<b>Low-Height Cylinders</b>				
	RCS-101	1.50	10	28	SCL-101TB
	RCS-201	1.75	20	33	SCL-201TB
	RCS-302	2.44	30	37	SCL-302TB
	RCS-502	2.38	50	44	SCL-502TB
 RSM Series	<b>Flat-Jac® Cylinders</b>				
	RSM-100	0.44	10	26	SRS-100TB
	RSM-200	0.44	20	28	SRS-200TB
	RSM-300	0.50	30	31	SRS-300TB
	RSM-500	0.63	50	37	SRS-500TB

▼ Shown from left to right: JHA-356, JHA-156



## JH, JHA Series

Capacity:  
**7-150 tons**

Stroke:  
**3.00-6.13 inches**

Maximum Operating Pressure:  
**10,000 psi**

- All-directional operation on 7, 15 and 35-ton models (JHA- Series)
- Internal relief valve to prevent overloading
- Machined flat front and bottom surfaces permit flush alignment in tight corners
- All models include pumping handle
- Chrome-plated plungers
- Automatic by-pass port to prevent over-extension (JH-Series)



### Lifting Wedge and Machine Lifts

Ideal to lift the load the first few inches. The **LW-16** Lifting Wedge requires a very small access gap of only .39 inch.

Page: 192



### Load Skates

For moving heavy loads easily and safely.

Page: 194

Style	Jack Capacity	Stroke	Model Number	Jack Effective Area	Collapsed Height	Extended Height	Bottom Plate Dimensions (W x L)	Plunger Diameter	Pump Speed	Weight
	(ton)	(in)		(in <sup>2</sup> )	(in)	(in)	(in)	(in)		(lbs)
Aluminum Jack	7	3.00	JHA-73	1.49	5.25	8.25	2.88 x 6.25	1.19	Single	11
	15	6.06	JHA-156	3.14	9.75	15.81	3.63 x 9.38	1.63	Single	29
	35	6.13	JHA-356	7.07	10.13	16.25	4.63 x 10.00	2.13	Single	40
	75	6.06	JHA-756	15.90	11.25	17.31	6.88 x 12.81	4.50	Single	94
	150	6.13	JHA-1506	30.68	12.88	19.00	9.50 x 16.06	6.25	2-Speed	210
Steel Jack	30	6.13	JH-306	5.94	10.00	16.13	3.75 x 9.56	2.75	Single	59
	50	6.09	JH-506	9.62	10.25	16.34	5.00 x 10.19	3.50	2-Speed	90
	100	6.06	JH-1006	20.63	11.31	17.37	7.13 x 12.94	5.12	2-Speed	184

▼ Shown: GBJ-010, GBJ-030, GBJ-003



- Lower handle effort reduces operator fatigue
- Fully serviceable
- High-strength beam and pump linkage for long life
- Pumping handle included on all models
- Safety relief valve to prevent overload
- Automatic by-pass port to prevent over-extension
- Wiper seal for extended life
- Thick base material with large area for increased strength and stability during lifting

## GBJ Series

Capacity:

**2-100 tons**

Stroke:

**2.44-18.11 inches**



### Screw Feature

Heat treated, adjustable extension screw with cleated saddle on selected GBJ models helps adjusting and prevents slipping.

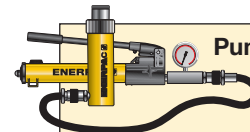

### Pump and Cylinder Sets

As an alternative to Industrial Bottle Jacks where the operator is required to stand remote from the jacking point, see the range of pump and cylinder sets.

Page: 52

▼ Enerpac heavy-duty hydraulic bottle jack makes lifting loads easier.



Jack Cap.	Stroke	Model Number	Screw Extension	Min. Height	Max. Height	Plunger Dia.	Saddle Dia.	Base Dims. L x W	Wt
(ton)	(in)		(in)	(in)	(in)	(in)	(in)	(in)	(lbs)
2	18.11	GBJ002L	-	22.44	40.55	1.14	-	5.00 x 5.00	13.2
2	3.94	GBJ002	1.97	6.30	12.20	0.83	0.83	3.74 x 4.37	7.9
3	4.13	GBJ003	2.56	6.61	13.31	0.94	0.94	3.74 x 4.57	8.6
5	5.91	GBJ005	2.95	8.35	17.20	1.14	1.14	3.74 x 4.84	11.0
8	5.91	GBJ008	2.95	8.62	17.48	1.30	1.46	3.74 x 5.43	13.0
10	5.91	GBJ010	2.95	8.62	17.48	1.46	1.46	3.74 x 5.59	14.3
10	2.44	GBJ010S	1.18	5.16	8.78	1.46	1.46	3.74 x 5.59	12.1
15	5.91	GBJ015	2.95	8.98	17.83	1.75	1.73	4.41 x 6.42	19.8
20	5.91	GBJ020	2.95	9.21	18.07	2.01	2.28	5.00 x 6.73	26.7
20	4.13	GBJ020S	2.17	7.48	13.78	2.01	2.28	5.00 x 6.73	22.0
30	5.91	GBJ030	2.95	9.53	18.39	2.26	2.56	5.59 x 7.72	34.2
50	5.91	GBJ050	-	9.92	15.83	3.15	3.15	7.09 x 9.06	62.8
100	5.91	GBJ100	-	11.81	17.72	4.33	3.70	11.65 x 13.11	191.8

All GBJ Jacks meet or exceed: ANSI, PALD, CE

▼ Shown: PRASA10027L and Accessory Locking U-Rings



## Safe, Efficient, Mobile Load Lifting

- 60, 100, 150 and 200-ton capacities with pneumatic or electric pumps for the toughest jobs
- 4-inch ground clearance for transport over rail and rough terrain
- Three-position handle provides easy tilt back and transport
- Complies with ASME/ANSI B30.1:2015 & CE specifications
- Easy-to-change external filter minimizes down time
- Rugged, fully enclosed 24-inch wide frame with no exposed fittings or hoses
- SUP-R-STACK™ Extension System allows lifting at all heights without blocking.



### Pendant Cord

Standard 12' pendant cord for air driven units with pneumatic valves and 20' pendant cord for electric driven units keeps operator away from the load.

▼ Enerpac POW'R-RISER® used in mining operations to lift heavy equipment.



Capacity	Stroke	Electric Pump Model Number	Weight
(ton)	(in)	(115 VAC)	(lbs)
60	14	PREMB06014L	390
	27	PREMB06027L	600
100	16	PREMB10016L	510
	27	PREMB10027L	600
	16	-	-
150	27	-	-
	15.5	-	-
	26.5	-	-
	15.5	PREMB15016L	570
200	26.5	PREMB15027L	708
	15.3	-	-
	24.3	-	-

(PR-Series not available in Canada. Contact Enerpac.)

# POW'R-RISER® Lifting Jack



## SUP-R-STACK™ Extensions

Increase useful height from 5" to 18".

Model No.	Size (in)	Model No.	Size (in)
PRE5	5	PRE11	11
PRE7	7	PRE14	14
PRE9	9	PRE18	18
PRES6024	Extension set includes PRE5, PRE7, PRE11, PRE18		

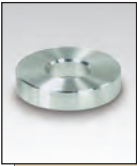

## Spacers

Fine tune your Extension stack height.

Model No.	Size (in)	Model No.	Size (in)
PRS1	1	PRS3	3
PRS2	2	-	-
PRS4	Set includes (2) PRS1, (1) PRS2 and (1) PRS3		

## PR Series



Rated Lifting Capacity:

**60-200 tons**

Stroke:

**14-27 inches**

Maximum Operating Pressure:

**10,000 psi**



### WARNING!

**Extensions:** Any two Extensions may be stacked for loads up to 60 tons. For loads over 60 tons or strokes over 14" only one Extension and one Spacer can be used.

**Spacers:** Never exceed 3" in total Spacer height.

Cap. (ton)	Swivel Load Cap	Locking U-Rings					Set Model Number	Locking U-Ring Sets Include							
		1 in.	3 in.	4 1/4 in.	5 1/2 in.	10 in.		(quantity and model numbers)							
								2X	1X	2X	1X				
60	PRTS60	PRU11	PRU13	PRU14	-	PRU110	1) PRUS126	PRU11	PRU13	PRU14	-				
							2) PRUS137	PRU11	PRU13	PRU14	PRU10				
100	PRTS60	PRU11	PRU13	PRU14	-	PRU110	1) PRUS126	PRU11	PRU13	PRU14	-				
							2) PRUS137	PRU11	PRU13	PRU14	PRU110				
150	PRTS150	PRU151	PRU153	-	PRU155	PRU1510	3) PRUS1526	PRU151	PRU153	PRU155	-				
							2) PRUS1537	PRU151	PRU1510	PRU155	-				
200	PRTS200	PRU201	PRU203	-	PRU205	PRU2010	3) PRUS2026	PRU201	PRU203	PRU205	-				
							2) PRUS2037	PRU201	PRU2010	PRU205	-				

<sup>1)</sup> For 14 and 16" stroke models

<sup>2)</sup> For 27" stroke models

<sup>3)</sup> For 15.5" stroke models

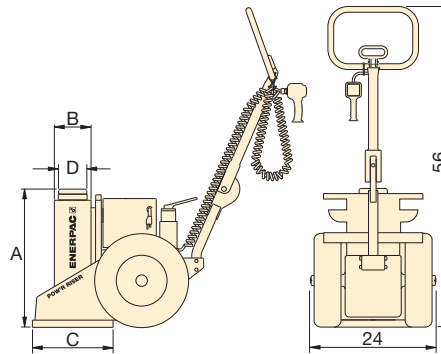

### Locking U-Rings

For safe mechanical cribbing of a lifted load, accessory Locking U-Rings can be placed around an extended piston and come in four lengths for each POW'R-Riser® capacity, and are available individually or in sets. Locking U-Rings are accommodated by storage racks integral to the POW'R-Riser®.

Air Pump	Weight (lbs)	A (in)	B (in)	C (in)	D (in)	Max. Additional Stack Height Using Optional Ext. System (in)	Valve Type
PRAMA06014L	390	24	6.4	14	4	32*	Manual
PRAMA06027L	600	37	6.4	14	4	11	
PRAMA10016L	510	26	7.0	18	4	21**	
PRAMA10027L	600	37	7.0	18	4	11	
PRASA10016L	510	26	7.0	18	4	21**	Pneumatic
PRASA10027L	600	37	7.0	18	4	11	
PRASA15016L	570	26	8.0	18	5	21**	
PRASA15027L	708	37	8.0	18	5	11	
-	-	26	8.0	18	5	21**	Manual
-	-	37	8.0	18	5	11	
PRASA20016L	640	26	9.5	20	6	21**	Pneumatic
PRASA20027L	825	37	9.5	20	6	11	

For power source, the following characters should be inserted in the 5th space of the model number.

### Ordering Example:

**Model No. PREMI06014L** is a 14" stroke, 60 ton model, with a manual valve and a 208-240 VAC, 1-ph electric motor.

- A Air Pump, 50 scfm, 80 psi
- B 115 VAC, 1-ph., 50-60 Hz, 20 A
- E 208-240 VAC, 1-ph., 50-60 Hz, Euro Plug, 10 A
- I 208-240 VAC, 1-ph., 50-60 Hz, USA Plug, 10 A
- G <sup>1)</sup>208-240 VAC, 3-ph., 50-60 Hz
- W <sup>1)</sup>380-415 VAC, 3-ph., 50-60 Hz
- J <sup>1)</sup>440-480 VAC, 3-ph., 50-60 Hz
- R <sup>1)</sup>575 VAC, 3-ph., 50-60 Hz

<sup>1)</sup> Not available for 60-ton capacity

\* Based on one 18" and one 11" Extension and one 3" Spacer.

\*\* Based on one 18" Extension and one 3" Spacer.



▼ Shown: PL20025-ASA and PL20014-ASA



## Efficient Lifting with Continuous, Automatic Load Locking



### Pow'R-LOCK™ Self-Locking Lift System

Only the Pow'R-LOCK™ Lift System provides continuous positive locking of the load through all stages of lifting and lowering. No operator intervention is required to activate or deactivate the automatic locking system.

Two different stroke lengths are available. Both models are powered by an external compressed air system (user-supplied). A convenient two-button pendant controls operation of the Lift System's air motor and directional control valve.

- Provides continuous locking protection during lift, lower and hold functions
- Patent-pending control technology synchronizes cylinder and lock nut for smooth and efficient lifting and lowering
- Unique double-acting cylinder offers a low collapsed height to accommodate more lifting applications
- Simple 2-button pendant allows operation of raise and lower functions from up to 20 feet away
- All exposed load-bearing steel cylinder components utilize a nitrocarburizing treatment to reduce wear and resist corrosion
- Ergonomic handle has six positions for comfortable handling and folds when not in use
- Meets ANSI /ASME B30.1-2015, AS/NZS-2538, AS/NZS-2693 certification criteria



### Tilt Load Cap

All Pow'R-LOCK™ Lift System models feature a Tilt Load Cap to reduce side-loading.



Enerpac declares that this product has been tested and conforms to applicable standards and is approved to carry the CE mark. An EU Declaration of Conformity is enclosed separately.

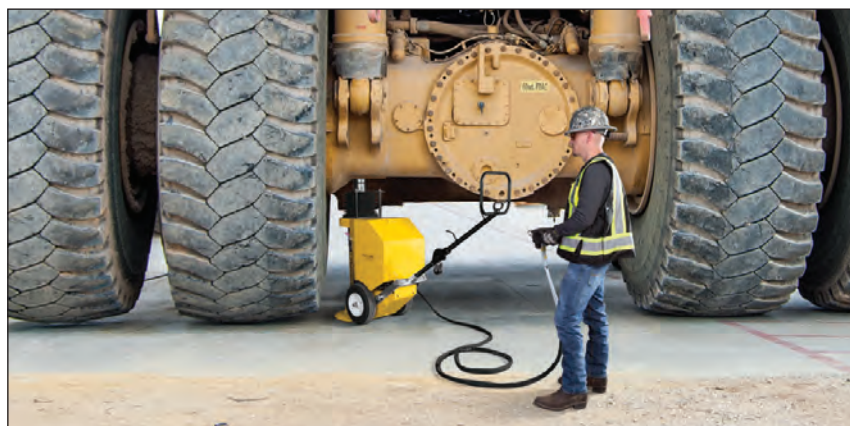

◀ The PL-Series Pow'R-LOCK Portable Lift System.

# PL-Series, Pow'R-LOCK™ Portable Lift System



## Accessories

**Flat Load Cap** – Non-tilt load cap has lower profile for tight lifting spaces.

**Spacers** – Minimize gap between load cap and lifting point to maximize hydraulic stroke of the jack.

**Extensions** – Stackable, with large alloy steel locating studs to resist effects of side-loading.

**Extension Base Adapter** – Extension Base Adapter design eliminates risk of improper stacking when using more than one extension.



## PL Series

Rated Lifting Capacity:

**200 tons**

Stroke:

**14 or 24.5 inches**

Maximum Operating Pressure:

**10,000 psi**

## ▼ ACCESSORIES

	Model Number	Description	Height (in)	PL20014-ASA	PL20025-ASA
	PLC1	Flat Load Cap	1.3	x	x
	PLS1	Spacer	1.0	x	x
	PLS2	Spacer	2.0	x	x
	PLE5	Extension	5.0	x	x
	PLE7	Extension	7.0	x	x
	PLE9	Extension	9.0	x	x
	PLE11	Extension	11.0	x	–
	PLE14	Extension	14.0	x	–
	PLB12	Extension base adapter	12.0	x	–



### WARNING!

**PLE11** and **PLE14** Extensions and **PLB12** Extension Base Adapter are to be used with the "short" model **PL20014-ASA** only.

Use of these extensions on the "tall" model **PL20025-ASA** will result in an excessive maximum lifting height. Load could become unstable and drop, resulting in possible personal injury and/or property damage.

Model No.	Max. Additional Stack Height* (in)
PL20014-ASA	28.0
PL20025-ASA	9.0

\* Using optional PLB and PLE-Series extensions and PLS-Series spacers. Load cap height is NOT included in the stack height.



### Safety First

When lifting large, heavy vehicles certain precautions must be followed. Follow your published safety directions for lifting and cribbing your loads.

The **Pow'R-LOCK™** Lift System provides load/lock protection, but you must follow the safety directions for load cribbing operations.

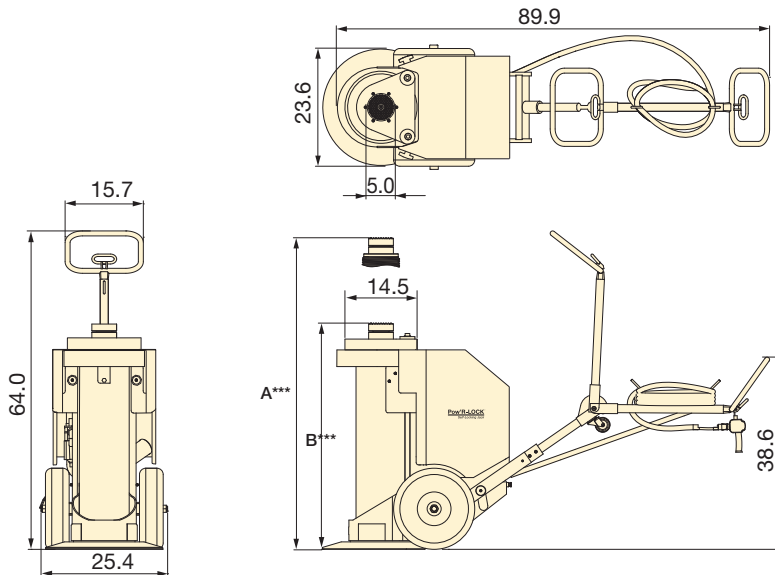

Capacity (ton)	Stroke (in)	Model Number	Cylinder Lifting Speed * in/min		Recommended Air Supply**		A *** (in)	B *** (in)	Wt. (lbs)
			Load	No Load	(CFM)	(psi)			
200	14.0	PL20014-ASA	2.0	2.4	130-150	55-100	48.0	34.0	1105
	24.5	PL20025-ASA	2.0	2.4					

\* Depending on available airflow, regulator setting, pump speed and load weight.  
 \*\* Minimum dynamic air pressure of 55-60 psi, 90-100 psi required to achieve 200-ton capacity.  
 \*\*\* Height of items A and B is with swivel load cap installed. Subtract 2-inches if flat load cap is used.



### Pow'R-RISER® Lifting Jack

When automatic load-locking is not required, the Enerpac **Pow'R-RISER®** jack provides a mobile lifting solution.

For more information go to:  
[www.enerpac.com](http://www.enerpac.com)

▼ Shown: **BLS-1006**



- Climbing Jacks include integral tilt saddles with maximum tilt angles up to 5°
- Large base with anti-rotation rod for stability and safety
- Built-in safety valve prevents accidental over-pressurization
- Baked enamel finish for increased corrosion resistance
- CR-400 couplers included on all cylinder models

## A Simple Solution to Incremental Lifting



### Lifting Height

Climbing Jacks overcome the usual limitation of lift height imposed by the jack's plunger stroke length. Large objects, such as oil tanks, can be lifted, held and lowered for maintenance without sending for a crane.



### Split-Flow Pumps

SFP-Series Pumps with multiple outlets with equal oil flow. For lifting applications on multiple points Split-Flow

Pumps are a far better alternative than using independently operated pumps.

Page: 118



### EVO-Series, Synchronous Lifting Systems

The EVO-system is the ideal system for stage lifting. The system has 9 work modes

including the stage lift work mode to easily step through each stage of the lifting cycle.

Page: 120

▼ Synchronous Stage Lifting: 48 double-acting jacks (25 and 50 ton) are networked into a 16 point synchronous system to lift this 164-foot, 1100-ton building up to a height of 8-feet to construct a new floor level.



Cylinder Capacity (tons)	Stroke (in)	Model Number	Max. Cylinder Capacity (tons)	
			Push	Pull
55	5.91	BLS-506	55	12
105	6.34	BLS-1006	105	48
154	5.94	BLS-1506	154	74
220	5.94	BLS-2006	220	113

# Double-Acting Climbing Jacks



◀ Typical stage-lift application using a custom built Enerpac system to lift the 360 ton Akkerwinde wooden bridge in the Netherlands.

## BLS Series



Capacity per Lifting Point:

**55 - 220 tons**

Stroke per Stage:

**5.91 - 6.34 inches**

Maximum Operating Pressure:

**10,000 psi**

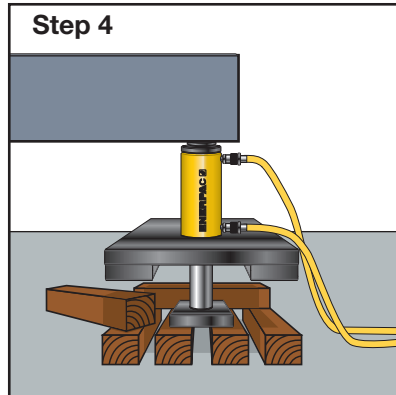
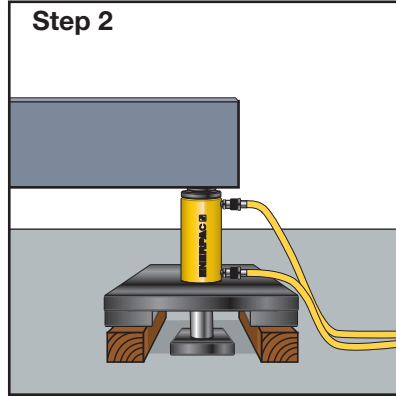
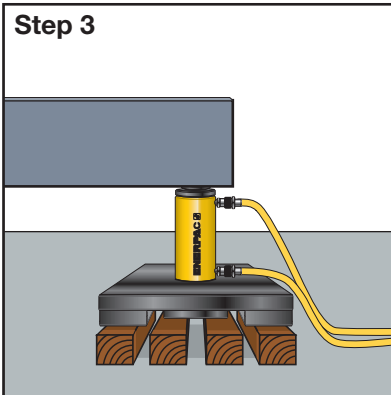
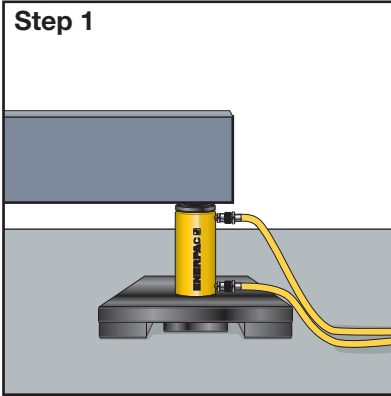

### ▲ Stage Lifting Sequence

**Step 1:** The Climbing Jack is placed on a solid support under the load (retracted plunger).

**Step 2:** Plunger extends, lifting the load and giving clearance to insert two outer blocks under the spreading plate.

**Step 3:** Plunger retracts, giving clearance to position the central blocks which will support the plunger plate for the next extension.

**Step 4:** Plunger extends, lifting the load, giving clearance to insert two new blocks, placed crosswise under the spreading plate.

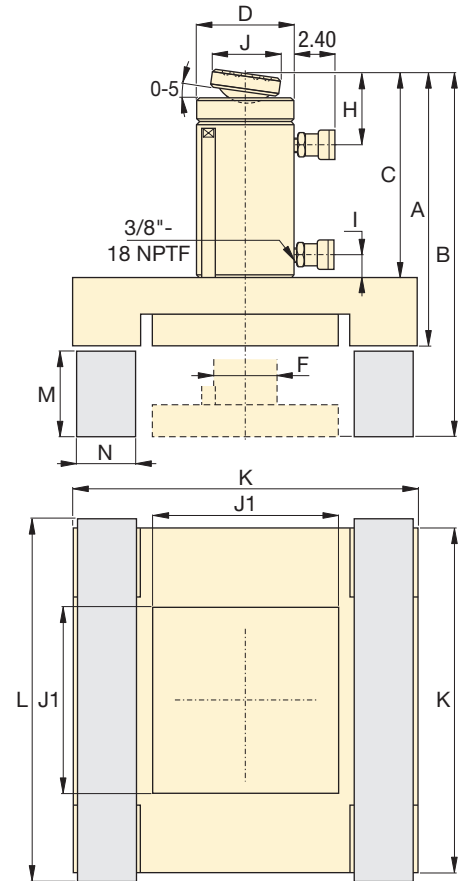

Cylinder Effective Area (in <sup>2</sup> )		Oil Capacity (in <sup>3</sup> )		Climbing Jack Dimensions (in)											Support Blocks * and Dimensions (in)			Wt. (lbs)	Model Number
Push	Pull	Push	Pull	A	B	C	D	F	H	I	J	J1	K	Material	L	M	N		
11.04	3.33	67.80	20.44	15.98	21.89	12.52	5.00	3.11	2.24	1.42	1.97	9.45	20.28	Azobe Wood	22.24	5.51	4.72	375	<b>BLS-506</b>
20.66	9.64	136.57	63.77	17.52	23.86	13.50	6.97	3.74	2.99	0.94	2.80	12.99	26.38		28.35	5.91	6.30	695	<b>BLS-1006</b>
30.71	14.79	188.56	90.80	18.58	24.57	14.57	8.00	4.49	3.70	1.54	5.12	9.06	18.70	Solid aluminum or steel	19.69	5.51	4.53	710	<b>BLS-1506</b>
44.21	22.50	264.35	134.80	20.08	26.02	15.24	9.76	5.24	4.02	1.46	5.12	10.63	21.65		22.64	5.51	5.31	825	<b>BLS-2006</b>

\* Support blocks are not supplied by Enerpac.

▼ SHS-Series 4-Point SyncHoist System



## Accurate Hoisting and Load Positioning Enhancing a Crane's Capability



### Synchronous Hoisting

Enerpac SyncHoist is a unique crane product for below-the-hook positioning of heavy loads that require precision placement. The SyncHoist system may reduce the number of cranes needed and reduce the costs of multiple picks.

#### Functions

- High precision horizontal and vertical load positioning
- Pre-programmed positioning, tilting and aligning

#### Applications

- Positioning of rotor, stator and propeller blades of wind turbines
- Positioning of roof sections, concrete elements, steel structures
- Positioning of turbines, transformers, fuel rods
- Precise machinery loading, mill rod changes, bearing changes
- Precise positioning of pipe lines, blow out valves
- Positioning and aligning of ship segments prior to assembly

- High-precision load maneuvering using one crane
- Reduces the risk of damage from oscillations of wire rope due to crane jogging and sudden starts/stops
- Vastly improving worker safety, operating speed and control
- PLC-controlled hydraulics turn lifting into high-accuracy hoisting and load positioning system
- Double-acting push/pull cylinders with load-holding valves for added safety
- Increased efficiency compared to conventional load positioning methods

#### Options for system management and control:

- Manual control: system warning functions
- Automatic control: fully PLC-monitored system with programmable functions using touch screen and system warning functions
- Wireless control: self-contained hydraulics with hand-held control

▼ Bridge segments are hoisted from the ground, being positioned with a 4-point SyncHoist system with fully monitored cylinders.



▼ SyncHoist Powerpack to operate the 4 lifting points.



▼ A SyncHoist system used to align steel blocks of the ship's control tower sections allowing gradual lifting and positioning of the load.



# SyncHoist - High Precision Load Positioning



## What is SyncHoist?

Enerpac SyncHoist is a hydraulically operated auxiliary attachment for high precision load positioning for cranes. The SyncHoist system can be used for pre-programmed positioning, tilting and aligning of loads.

- Complete system tested in compliance with European lifting directive and safety requirements
- BTH-1 - 2014 compliant design of below-the-hook lifting devices

### SyncHoist improves safety, operating speed and control of load movement

Geometric positioning of heavy loads in a horizontal and vertical plane are frequently done using more than one crane. Synchronizing movements between cranes are difficult and risky. The lifting inaccuracy can result in damage to the load and support structures and puts workers at risks. The SyncHoist system can be used for controlled hydraulic horizontal and vertical material handling.

### System management and control

Contact Enerpac for the following options, or other customized stroke, capacity and control configurations.

### 1. Manual control

- Valves with manual levers
- Warnings for thermal motor protection
- Visual check: oil level, filter indicator

### 2. Automatic control

- Load and stroke monitoring, and stroke control
- PLC-control and touch screen
- Solenoid valves with pendant
- Pre-programmable motions and data recording
- System warnings for:
  - maximum cylinder load control setting
  - stroke and position control
  - thermal motor protection
  - oil level and filter indicator

### Autonomous (wireless) system

- Wireless remote control
- Only one electric power connection per lifting point
- Integrated hydraulics, PLC and controls
- No need for hydraulic hoses and cables
- No need for mid-hoist disconnection of hoses and movement of pump

## SHS/ SHAS Series

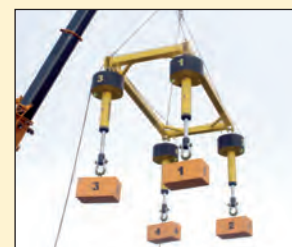

Capacity:

**60 - 250 ton**

Maximum Stroke:

**19.69 - 59.06 inches**

Accuracy Over Full Stroke:

**± .040 inches**

Maximum Operating Pressure:

**10,000 psi**

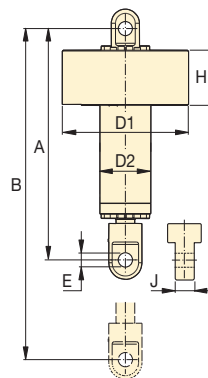

Capacity (ton)	Total Load (ton)	Cylinder Stroke (in)	Model Number <sup>1)</sup> 460-480 VAC, 3 ph - 60 Hz	Control System	Motor Size (hp)	Number of Pump Outlets and Oil Flow <sup>2)</sup> (in <sup>3</sup> /min)	Cylinder Dimensions (in)							Wt. (lbs) <sup>3)</sup>
							A	B	D1	D2	E	H	J	
4 x 60	240	19.69	SHS 45520 MJ	Manual	10	4 x 85	51.18	70.87	27.17	9.65	2.32	15.16	3.15	992
		39.37	SHS 45540 MJ				70.87	110.24						1378
		59.06	SHS 45560 MJ				90.55	149.61						1764
		19.69	SHS 45520 AJ	Automatic	20	4 x 128	51.18	70.78	27.17	9.65	2.32	15.16	3.15	992
		39.37	SHS 45540 AJ				70.87	110.25						1378
		59.06	SHS 45560 AJ				90.55	149.61						1764
4 x 94	376	19.69	SHS 48520 MJ	Manual	15	4 x 128	52.36	72.05	27.17	10.43	2.83	15.16	3.94	1102
		39.37	SHS 48540 MJ				72.05	111.42						1543
		59.06	SHS 48560 MJ				91.73	150.79						1984
		19.69	SHS 48520 AJ	Automatic	20	4 x 128	52.36	72.05	27.17	10.43	2.83	15.16	3.94	1102
		39.37	SHS 48540 AJ				72.05	111.42						1543
		59.06	SHS 48560 AJ				91.73	150.79						1984
4 x 120	480	39.37	SHS 411040 MJ	Manual	15	4 x 128	23.03	112.40	30.71	12.40	3.35	15.55	4.88	2138
		59.06	SHS 411060 MJ				92.72	151.77						2723
		39.37	SHS 411040 AJ	Automatic	20	4 x 128	73.03	112.40	30.71	12.40	3.35	15.55	4.88	2138
		59.06	SHS 411060 AJ				92.72	151.77						2723
4 x 120	485	39.37	SHAS 411040 WU <sup>4)</sup>	Wireless	4 x 5	—	73.03	112.40	41.85	12.40	3.36	21.26	4.88	2608
		59.06	SHAS 411060 WU <sup>4)</sup>				92.72	151.77						3192
4 x 250	991	39.37	SHAS 422540 WU <sup>4)</sup>	Wireless	4 x 10	—	84.25	123.62	48.62	16.54	5.59	22.83	7.48	7097
		59.06	SHAS 422560 WU <sup>4)</sup>				103.94	143.31						7527

<sup>1)</sup> With 4 cylinders and one 460-480 VAC-3 phase-60 Hz power pack (suffix J). For 400 VAC-3 phase-50 Hz power pack change suffix J into W. Example: SHS 45560 MW.

<sup>2)</sup> Pump and cylinders include 4x 82 feet hydraulic hoses with couplers. <sup>3)</sup> Weight per cylinder.

<sup>4)</sup> WU = with US electrical wiring. Change into suffix "WE" for EU-market. Example: SHAS 411060 WE.

# Custom Hydraulic Cylinders

**There's no substitute for experience in customizing hydraulic cylinders and Enerpac meets the needs of the most demanding applications.**

Cylinders are the primary workhorse in hydraulic systems required to push or pull. Although Enerpac offers a wide variety of cylinders to fit many application requirements there are many

applications which require customization. These may include special corrosion protection, ability to handle extreme side loads, or having special mounting needs.



◀ *Large capacity cylinders for extreme applications.*



◀ *Cylinders with special attachments.*



◀ *Custom private labeled cylinders for OEM applications.*

## OVERVIEW

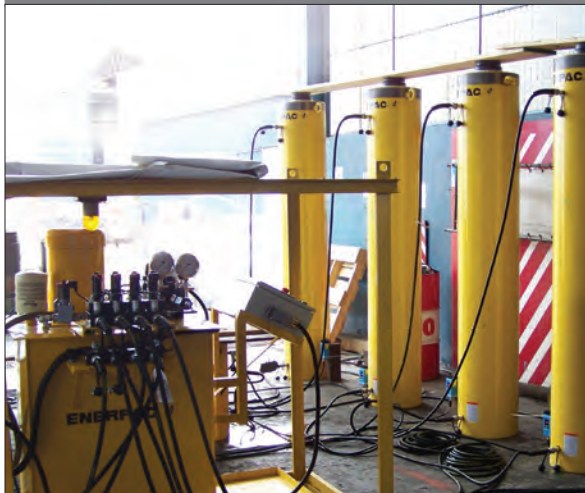

▲ *Custom 500-ton cylinders with 72-inches of stroke for lifting electric rope shovels.*

## CUSTOMIZABLE FEATURES:

- Stroke
- Capacity
- Paint
- Pressure Rating
- Fitting
- Special Attachments
- Seals
- Imbedded Sensors
- Collapsed Height
- Rod Modifications
- Special Mounting
- Corrosion Resistance

## INFRASTRUCTURE



◀ Custom cylinders used for incremental bridge launching systems.

## BUILDING CONSTRUCTION



◀ Custom cylinders for jack and slide operations.

## INFRASTRUCTURE



◀ Custom SyncHoist cylinders for placement of stadium roof trusses.

## POWERGEN



◀ Custom double-acting lock-nut cylinders with internal stroke sensors and an integrated load holding valve for lifting nuclear components.

## INFRASTRUCTURE



◀ Custom cylinders with embedded sensors for bridge construction.

## POWERGEN



◀ One of three custom SyncHoist cylinders used to place a 1,140-ton nuclear plant module.