



Power Tool Accessories and Hand Tools



IVY Classic Industries, Inc.

40 Plain Avenue • New Rochelle, NY 10801 USA

Tel: 914-632-8200
800-435-3867

Fax: 914-632-6449
800-552-2997

www.ivyclassic.com
e-mail: sales@ivyclassic.com

PC1010

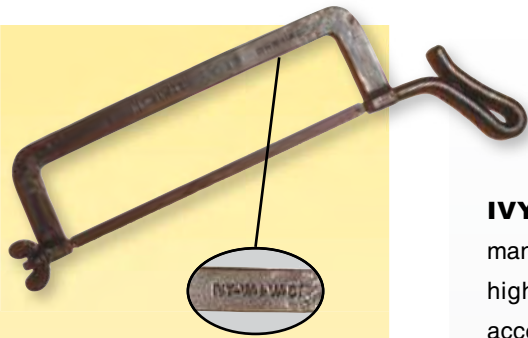

From Our Humble Beginning

IVY Wrought Iron Works was established in 1929 by an English blacksmith named Albert George Story. Many of his original tools are on display at IVY Classic Industries. Originally the name **IVY** was chosen as it was made up of three letters that were all straight lines. These straight letters could easily be cut into any **IVY** product before the company could afford a steel letter punch. Today **IVY Classic Industries** is still a family-owned-and-operated business continuing the traditions of Mr. Albert George Story.



IVY Classic is dedicated to manufacturing a comprehensive, high-quality line of power tool accessories and hand tools for the contracting, industrial and DIY markets. All our tools are subject to strict quality-control procedures to ensure they meet our exacting standards.



We Set Very High Standards

We Meet Your Needs



We continually update our package designs to help you effectively promote **IVY Classic** products. We use the latest in packing materials, and our product cards are bar coded and clearly labeled with valuable information to make any job easier.

We are very proud of our complete assortment of display merchandisers throughout the product line. Our merchandisers are carefully arranged to include the best-selling items in an organized, space-saving layout.





Cobalt
Advantedge®



IVY Classic
LASER CARBIDE®

Swift Cut Plus

Diamond Plus™

Rapid Reload®

Hinge Loc®

Rip Across®

Flex-Abrasive®

Premium Diamond™

Power Pro Grip®

Swift Cut®

Swift Bore®

**Our Brands,
Trademarks
Today**

Our Marketing Tools



Our marketing department is always ready to help. We offer full-color catalogs, brochures and regular promotional materials to help you sell our products. In addition, our extensive nationwide network of sales representatives makes effective use of our mobile show vans.

Our website offers you the convenience of placing an order day or night. You can also track your order online.

Visit our website:
www.ivyclassic.com



Lifetime Warranty

IVY Classic products are warranted against defects in material and workmanship for the life of the tool. This warranty does not apply to normal wear and tear or damage caused by abuse, misuse or alteration.

100% Satisfaction

If you are not completely satisfied with any new **IVY Classic** product, please advise us within 90 days, and we will gladly exchange the product or issue a full credit at your request. Buy with complete confidence.

100% Satisfaction

Safety Warning

To avoid risk of injury when using or in the vicinity of power tool accessories or hand tools always wear safety goggles and other appropriate safety items for protection. Failure to do so can result in bodily injury.

IVY Classic Industries, Inc.

40 Plain Avenue
New Rochelle, NY 10801 USA

Tel: 914-632-8200

Tel: 800-435-3867

Fax: 914-632-6449

Fax: 800-552-2997

www.ivyclassic.com

email: sales@ivyclassic.com

OUR DISPLAY PROGRAM

D We have 137 different displays to make ordering easy.

Throughout the catalog you will see this display symbol. **D** It indicates that the products are available in an easy-to-order display. All of our displays contain the most popular tools and sizes.



With each display
RECEIVE FREE

- Colorful header.
- Fully detailed planogram.
- Scan pegboard hooks.
- UPC labels with product ID.

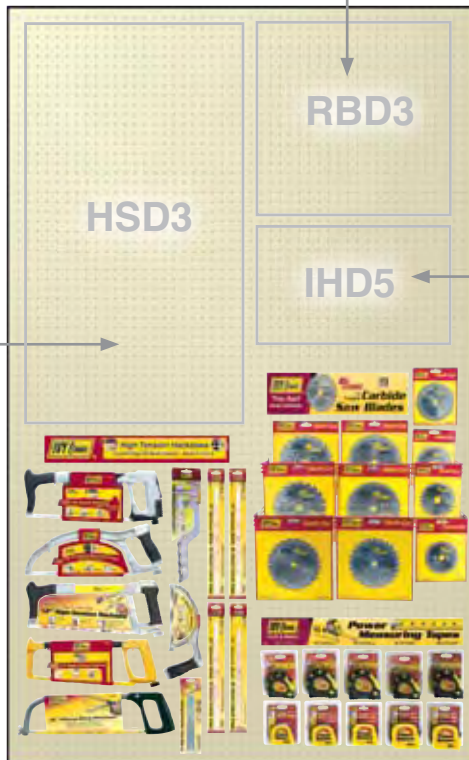

PLAN AND SELL

IVY Classic's TOTALLY flexible display system uses 4-color informational headers and metal-plate scan pegboard hooks (page 119) to create your optimum selling space.

We have digital photos to scale of all our displays to help you plan your space.

Call for a planogram kit to help lay out your tool wall.

Layout Example

OUR PLANOGRAM PROGRAM

OR

CUSTOMIZE

Create your own custom planogram.

Is the most convenient way to order our displays.

Four foot sections of pre-planned power tool accessories and hand tools can be combined, mixed and matched to create 24 feet or more of our best-selling merchandise with one simple order.

Simply give us the dimensions of your wall and we will create a planogram to suit your needs.

■ Power Tool Accessory Planogrammed Walls







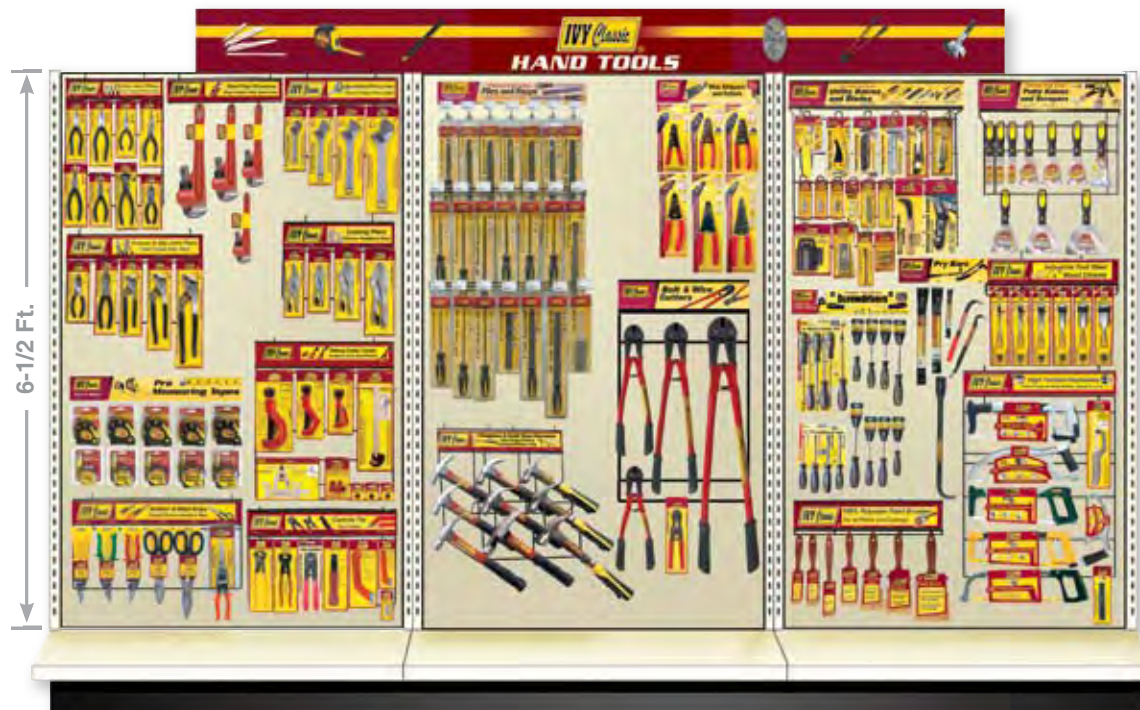



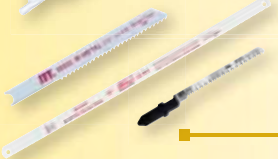
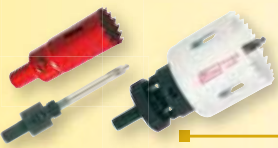

Example wall of IVY's 23 most popular Power Tool Accessory Displays.

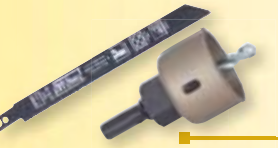
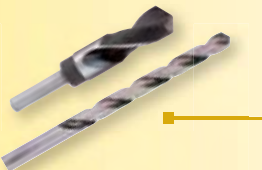
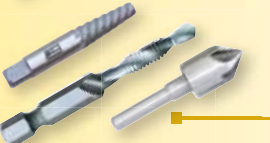
■ Hand Tool Planogrammed Walls

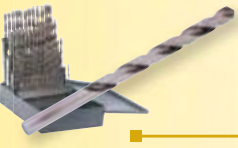

Example of IVY's 20 most popular Hand Tool Displays.

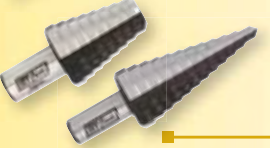
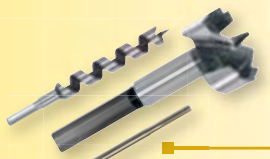
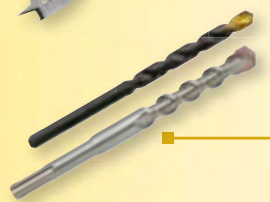
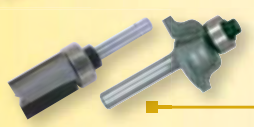
	Page
	8 - 9
	10 - 11
	12 - 15
	16 - 19
	20 - 23
	24 - 26
	27 - 29
	30 - 31
	32 - 35
	33 - 37

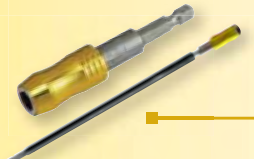
	Page
	36 - 37
	38 - 39
	40 - 41
	42
	43
	44 - 48
	49 - 52
	53 - 56
	57 - 71
	62 - 63



Cobalt Edge Bi-Metal Blades

Cobalt Advantedge



Made in U.S.A.



■ Bi-Metal Reciprocating Saw Blades - Pouched

- Cobalt Bi-Metal blades with 8% cobalt matrix III alloy-steel cutting edge.
- Teeth with Rockwell Hardness of 65-67 HRC.
- Cutting edge electron welded to a flexible, alloy-steel back.



Pouched - 5 blades per vinyl pouch

Prod.	Item	Lgth	TPI	Thick	Width	Cuts	Box/Case	Qty.
28302	R414P	4"	14	.035"	3/4"	Metal 1/8" and above	1 / 10	1
28304	R418P	4"	18	.035"	3/4"	Metal 1/16" - 1/4"	1 / 10	1
28306	R424P	4"	24	.035"	3/4"	Metal 1/16" and under	1 / 10	1
28308	R606P	6"	6	.035"	3/4"	Wood	1 / 10	1
28310	R610P	6"	10	.035"	3/4"	Non-ferrous & compositions	1 / 10	1
28312	R614P	6"	14	.035"	3/4"	Metal 1/8" and above	1 / 10	1
28314	R618P	6"	18	.035"	3/4"	Metal 1/16" - 1/4"	1 / 10	1
28316	R624P	6"	24	.035"	3/4"	Metal 1/16" and under	1 / 10	1
28318	R636P	6"	6	.035"	3/4"	Plaster	1 / 10	1
28320	R656P	6"	6	.050"	3/4"	Wood / Nail Cutting	1 / 10	1
28321	R676P	6"	6	.050"	7/16"	Wood with Curves	1 / 10	1
28322	R810P	8"	10/14	.050"	3/4"	Metal above 1/8", Cast Iron	1 / 10	1
28324	R818P	8"	18	.035"	3/4"	Metal 1/16" - 1/4"	1 / 10	1
28328	R956P	9"	6	.050"	3/4"	Wood / Nail Cutting	1 / 10	1
28330	R110P	12"	10/14	.050"	3/4"	Metal 1/8" and above	1 / 10	1
28331	R118P	12"	18	.035"	3/4"	Metal 1/16" - 1/4"	1 / 10	1
28332	R156P	12"	6	.050"	3/4"	Wood / Nail Cutting	1 / 10	1

Demolition Blades Pouched - 2 blades per vinyl pouch

28334	R966P	9"	6	.062"	7/8"	Demolition - Nailed Wood	1 / 10	1
28336	R960P	9"	10	.062"	7/8"	Demolition - Metal & Wood	1 / 10	1

D



D RBD1 - Pouched Bi-Metal Reciprocating Saw Blade Display



Size: 25"W, 19"H

Note: Also contains one pouch #26508 - 8" Grit Reciprocating Blade (p.30).

■ Bi-Metal Reciprocating Saw Blades - Bulk



Made in U.S.A.

Bulk - 50 blades per box

Product	Item	Lgth	TPI	Thickness	Box/Case
28350	R414B	4"	14	.035"	50 / 250
28352	R418B	4"	18	.035"	50 / 250
28354	R424B	4"	24	.035"	50 / 250
28356	R606B	6"	6	.035"	50 / 250
28358	R610B	6"	10	.035"	50 / 250
28360	R614B	6"	14	.035"	50 / 250
28362	R618B	6"	18	.035"	50 / 250
28364	R624B	6"	24	.035"	50 / 250
28366	R636B	6"	6	.035"	50 / 250
28368	R656B	6"	6	.050"	50 / 250



Product	Item	Lgth	TPI	Thickness	Box/Case
28370	R676B	6"	6	.050"	50 / 250
28372	R810B	8"	10/14	.050"	50 / 250
28374	R818B	8"	18	.035"	50 / 250
28376	R956B	9"	6	.050"	50 / 250
28378	R110B	12"	10/14	.050"	50 / 250
28379	R118B	12"	18	.035"	50 / 250
28380	R156B	12"	6	.050"	50 / 250
28386	R966B	9"	6	.062"	20 / 200
28388	R960B	9"	10	.062"	20 / 200

Cobalt Edge Bi-Metal Blades



■ Bi-Metal Reciprocating Saw Blades - Carded



Cobalt
Advantedge



Carded - 1 blade per card

Prod.	Item	Lgth	TPI	Thick	Width	Cuts	Box/Case	Qty.
28602	R414C	4"	14	.035"	3/4"	Metal 1/8" and above	5 / 50	5
28604	R418C	4"	18	.035"	3/4"	Metal 1/16" - 1/4"	5 / 50	5
28606	R424C	4"	24	.035"	3/4"	Metal 1/16" and under	5 / 50	5
28608	R606C	6"	6	.035"	3/4"	Wood	5 / 50	5
28610	R610C	6"	10	.035"	3/4"	Non-ferrous & compositions	5 / 50	5
28612	R614C	6"	14	.035"	3/4"	Metal 1/8" and above	5 / 50	5
28614	R618C	6"	18	.035"	3/4"	Metal 1/16" - 1/4"	5 / 50	5
28616	R624C	6"	24	.035"	3/4"	Metal 1/16" and under	5 / 50	5
28618	R636C	6"	6	.035"	3/4"	Plaster	5 / 50	5
28620	R656C	6"	6	.050"	3/4"	Wood / Nail Cutting	5 / 50	5
28621	R676C	6"	6	.050"	7/16"	Wood with Curves	5 / 50	5
28622	R810C	8"	10/14	.050"	3/4"	Metal above 1/8", Cast Iron	5 / 50	5
28624	R818C	8"	18	.035"	3/4"	Metal 1/16" - 1/4"	5 / 50	5
28628	R956C	9"	6	.050"	3/4"	Wood / Nail Cutting	5 / 50	5
28630	R110C	12"	10/14	.050"	3/4"	Metal 1/8" and above	5 / 50	5
28631	R118C	12"	18	.035"	3/4"	Metal 1/16" - 1/4"	5 / 50	5
28632	R156C	12"	6	.050"	3/4"	Wood / Nail Cutting	5 / 50	5
28634	R966C	9"	6	.062"	7/8"	Demolition - Nailed Wood	5 / 50	5
28636	R960C	9"	10	.062"	7/8"	Demolition - Metal & Wood	5 / 50	5

D RBD2 - Carded Bi-Metal Reciprocating Saw Blade Display



Size: 25"W, 19"H
Note: Also contains five cards #26509 - 8" Grit Reciprocating Blade (p. 30).

■ 1" Wide Bi-Metal Reciprocating Saw Blades

1" Wide Bi-Metal Blades prevent whip-like action with the advantage of a .042" kerf.



Each blade is also barcoded for individual sale.



Made in U.S.A.

Tubed - 5 blades per tube

Prod.	Lgth.	TPI	Cuts	Box/Case	Qty.
28776	6"	10	Structural Steel 3/16" - 1/2" Nail-Embedded Wood	1 / 10	1
28778	6"	14	Structural Steel & All Metals 3/32" - 3/8"	1 / 10	1
28779	6"	18	All Metals 1/16" - 1/4"	1 / 10	1
28780	6"	24	All Metals 1/16" & Under	1 / 10	1
28782	9"	10	Metals 3/16" - 1/2" Nail-Embedded Wood	1 / 10	1
28784	9"	14	Structural Steel & All Metals 3/32" - 3/8"	1 / 10	1
28785	9"	18	All Metals 1/16" - 1/4"	1 / 10	1
28788	12"	10	Metals 3/16" - 1/2" Nail-Embedded Wood	1 / 10	1
28790	12"	14	Structural Steel & All Metals 3/32" - 3/8"	1 / 10	1
28791	12"	18	All Metals 1/16" - 1/4"	1 / 10	1

D RBD3 - Tubed 1" Wide Bi-Metal Reciprocating Saw Blade Display



Size: 17"W, 16"H





Bi-Metal Jig and Hacksaw Blades

Cobalt Advantedge



Made in U.S.A.

- Cobalt Bi-Metal blades with 8% cobalt matrix III alloy-steel cutting edge.

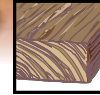

Bi-Metal Jig Saw Blades

Pouched - 5 blades per vinyl pouch

Universal Jig Saw Blades

Product	Item	Lgth	TPI	Cuts	Box/Case	Display
28200	J406P	4"	6	Wood	1 / 10	1
28202	J410P	4"	10	Metal/Wood	1 / 10	1
28204	J414P	4"	14	Metal	1 / 10	1
28206	J318P	3"	18	Metal	1 / 10	1
28208	J324P	3"	24	Metal	1 / 10	1

Width 3/8", Thickness .035"



Bosch® Style Jig Saw Blades

Product	Item	Lgth	TPI	Cuts	Box/Case	Display
28210	B406P	4"	6	Wood	1 / 10	1
28212	B410P	4"	10	Metal/Wood	1 / 10	1
28214	B314P	3"	14	Metal	1 / 10	1
28216	B318P	3"	18	Metal	1 / 10	1
28218	B324P	3"	24	Metal	1 / 10	1

Width 3/8", Thickness .035"



Porter Cable® Style Jig Saws

Product	Item	Lgth	TPI	Cuts	Box/Case	Display
28230	P306P	3"	6	Wood	1 / 10	1
28232	P310P	3"	10	Metal/Wood	1 / 10	1
28234	P314P	3"	14	Metal	1 / 10	1
28236	P218P	1 3/4"	18	Metal	1 / 10	1
28238	P224P	1 3/4"	24	Metal	1 / 10	1

28230, 28232, 28234 have: Width 3/8", Thickness .035"
28236, 28238 have: Width 1/4", Thickness of .035"



Carded - 1 blade per card

Universal Jig Saw Blades

Product	Item	Lgth	TPI	Cuts	Box/Case	Display
28500	J406C	4"	6	Wood	5 / 50	5
28502	J410C	4"	10	Metal/Wood	5 / 50	5
28504	J414C	4"	14	Metal	5 / 50	5
28506	J318C	3"	18	Metal	5 / 50	5
28508	J324C	3"	24	Metal	5 / 50	5

Width 3/8", Thickness .035"



Bosch® Style Jig Saw Blades

Product	Item	Lgth	TPI	Cuts	Box/Case	Display
28510	B406C	4"	6	Wood	5 / 50	5
28512	B410C	4"	10	Metal/Wood	5 / 50	5
28514	B314C	3"	14	Metal	5 / 50	5
28516	B318C	3"	18	Metal	5 / 50	5
28518	B324C	3"	24	Metal	5 / 50	5

Width 3/8", Thickness .035"



Porter Cable® Style Jig Saws

Product	Item	Lgth	TPI	Cuts	Box/Case	Display
28530	P306C	3"	6	Wood	5 / 50	5
28532	P310C	3"	10	Metal/Wood	5 / 50	5
28534	P314C	3"	14	Metal	5 / 50	5
28536	P218C	1 3/4"	18	Metal	5 / 50	5
28538	P224C	1 3/4"	24	Metal	5 / 50	5

28530, 28532, 28534 have: Width 3/8", Thickness .035"
28536, 28538 have: Width 1/4", Thickness of .035"



Cobalt Edge Bi-Metal Hacksaw Blades



Pouched - 10 blades per vinyl pouch

Product	Item	Lgth	TPI	Cuts	Box/Case	Display
28410	H1024P	10"	24	Metal	1 / 10	1
28418	H1218P	12"	18	Metal/Plastic	1 / 10	1
28424	H1224P	12"	24	Metal	1 / 10	1
28432	H1232P	12"	32	Metal	1 / 10	1

Width 1/2", Thickness .025"



Made in U.S.A.

JHD1 - Pouched Bi-Metal Jig and Hacksaw Blade Display



Size: 18"W, 21"H

Note: Also contains five each of the following grit blades.
26502 - 3" Bosch® Style
26504 - 3" Universal (p.30).

Carded - 1 blade per card

Product	Item	Lgth	TPI	Cuts	Box/Case	Display
28710	H1024C	10"	24	Metal	10 / 100	10
28718	H1218C	12"	18	Metal/Plastic	10 / 100	10
28724	H1224C	12"	24	Metal	10 / 100	10
28732	H1232C	12"	32	Metal	10 / 100	10

Width 1/2", Thickness .025"



Made in U.S.A.

JHD2 - Carded Bi-Metal Jig and Hacksaw Blade Display



Size: 18"W, 21"H

Note: Also contains five each of the following grit blades.
26502 - 3" Bosch® Style
26504 - 3" Universal (p. 30).

Jig Saw and Hacksaw Blades



High-Carbon Steel Jig Saw Blades



Bosch® Style Jig Saw Blades



Carded - 3 blades per card

Prod. Tooth
No. Lgth. TPI Type Cuts Box/Case



28570 3" 12 Ground Side Set Wood - Fine Scroll Cutting 5 / 20



28571 3" 20 Taper Ground Wood, Laminates Smooth Scroll Cut 5 / 20



28573 4" 6 Taper Ground Wood - Fast, Clean Straight Cutting 5 / 20



28574 4" 10 Taper Ground Wood - Fine, Clean Smooth Cutting 5 / 20



28575 4" 10 Taper Ground Wood, Laminates Down-Cutting 5 / 20



Universal Style Jig Saw Blades

Carded - 3 blades per card

Prod. Tooth
No. Lgth. TPI Type Cuts Box/Case



28540 2 3/4" 12 Ground Side Set Wood - Fine Scroll Cutting 5 / 20



28541 2 3/4" 20 Taper Ground Wood, Laminates Smooth Scroll Cut 5 / 20



28543 4" 6 Taper Ground Wood - Fast, Clean Straight Cutting 5 / 20



28544 4" 10 Taper Ground Wood - Fine, Clean Smooth Cutting 5 / 20



28545 4" 10 Taper Ground Wood, Laminates Down-Cutting 5 / 20



Bi-Metal Jig Saw Blades



Bosch® Style Jig Saw Blades

Carded - 3 blades per card

Prod. Tooth
No. Lgth. TPI Type Cuts Box/Case

28587 3" 14 Milled Set Metal Above 1/8" 5 / 20

28588 3" 18 Milled Set Metal 1/16" - 1/4" 5 / 20

28589 3" 24 Milled Set Metal Under 1/8" 5 / 20



Universal Style Jig Saw Blades

Carded - 3 blades per card

Prod. Tooth
No. Lgth. TPI Type Cuts Box/Case

28555 2 3/4" 14 Milled Set Metal Above 1/8" 5 / 20

28556 2 3/4" 18 Milled Set Metal 1/16" - 1/4" 5 / 20

28557 2 3/4" 24 Milled Set Metal Under 1/8" 5 / 20



5 Pc. Assorted Bosch® Style Jig Saw Set

28598 5 Pc. Set 5 / 20
Contains 28570, 28573, 28574, 28587, 28589

5 Pc. Assorted Universal Jig Saw Set

28568 5 Pc. Set 5 / 20
Contains 28540, 28473, 28544, 28555, 28557

Cobalt Edge Bi-Metal Hacksaw Blades - Bulk



Made in U.S.A.



Bulk - 100 blades per box

Product Item Lgth. TPI Cuts Box/Case

28450 H1024B 10" 24 Metal 100 / 300

28454 H1218B 12" 18 Metal/Plastic 100 / 300

28458 H1224B 12" 24 Metal 100 / 300

28462 H1232B 12" 32 Metal 100 / 300

D JSD - Bi-Metal & HSS Jig Saw Blade Display



Bi-Metal



Size: 25"W, 28"H
Note: Contains three cards of each jig saw blade listed on this page.





Bi-Metal Hole Saws

Variable Pitch Bi-Metal Hole Saws

Cobalt Advantedge



- Bi-Metal construction with M-3 cutting edge.
- Variable pitch, positive rake tooth design (4-6 TPI).
- Thick backing plate prevents stripping and increases torque.
- 1-1/2" cutting depth cuts through 2 x 4s.

Individually Boxed

Carded 1 per Card



Diameter	Pipe Tap Size	Pipe Ent. Size	Box/Case	Product	HSD1 Qty.	Product	HSD3 Qty.
5/8"			1 / 15	28010		27810	
3/4"	1/2"	3/8"	1 / 15	28012	1	27812	1
7/8"	3/4"	1/2"	1 / 15	28014	1	27814	1
1"			1 / 15	28016	1	27816	1
1-1/8"	1"	3/4"	1 / 15	28018	1	27818	1
1-1/4"			1 / 15	28020	1	27820	1
1-3/8"		1"	1 / 15	28022	1	27822	1
1-1/2"	1-1/4"		1 / 15	28024	1	27824	1
1-5/8"			1 / 15	28026	1	27826	1
1-3/4"	1-1/2"	1-1/4"	1 / 15	28028	1	27828	1
1-7/8"			1 / 15	28030	1	27830	1
2"		1-1/2"	1 / 15	28032	1	27832	1
2-1/8"			1 / 15	28034	1	27834	1
2-1/4"	2"		1 / 10	28036	1	27836	1
2-3/8"			1 / 10	28038		27838	
2-1/2"		2"	1 / 10	28040	1	27840	1
2-5/8"	2-1/2"		1 / 10	28042		27842	
2-3/4"			1 / 10	28044		27844	
2-7/8"			1 / 10	28046		27846	
3"		2-1/2"	1 / 10	28048	1	27848	1
3-1/8"			1 / 10	28050		27850	
3-1/4"	3"		1 / 10	28052		27852	
3-3/8"			1 / 10	28054		27854	
3-1/2"			1 / 10	28056	1	27856	1
3-5/8"		3"	1 / 10	28058		27858	
3-3/4"	3-1/2"		1 / 10	28060		27860	
3-7/8"			1 / 10	28062		27862	
4"			1 / 10	28064		27864	
4-1/8"		3-1/2"	1 / 10	28066	1	27866	1
4-1/4"	4"		1 / 5	28068		27868	
4-3/8"			1 / 5	28070		27870	
4-1/2"		4"	1 / 5	28072		27872	
4-3/4"	4-1/2"		1 / 5	28076		27876	
5"			1 / 5	28080		27880	
5-1/2"		5"	1 / 5	28088		27888	
5-3/4"			1 / 5	28092		27892	
6"			1 / 5	28096		27896	



D HSD1 - Bi-Metal Hole Saw and Arbor Display



Size: 16"W, 27"H

D HSD3 - Carded Bi-Metal Hole Saw and Arbor Display



Size: 23"W, 43"H

Hole Saw Arbors and Accessories



Arbors with 1/4" Pilot Drills

- Arbors adapt hole saws for use with power drills.

Standard Arbors 1/2" - 20 thread



Carded - 1 per card Fits 5/8" - 1-1/8" Hole Saws

Product	Item	Shank Size	Box/Case	HSD1 Qty.	HSD3 Qty.
28100	1H	7/16" - Hex	4 / 16	--	1
28104	4H	1/4" - 3 Flats	4 / 16	1	1
28105	5H	3/8" - Hex	4 / 16	1	1
28108*	1SH	SDS Plus Shank	1 / 12		

Bulk - 30 Arbors per box

28140	1H	7/16" - Hex	1 / 4
28142	4H	1/4" - 3 Flats	1 / 4
28143	5H	3/8" - Hex	1 / 4

* To be used in SDS Plus style drills that have a rotary drilling option. **Not for hammer drilling.**

Arbors With 2 Locking Pins 5/8" - 18 thread

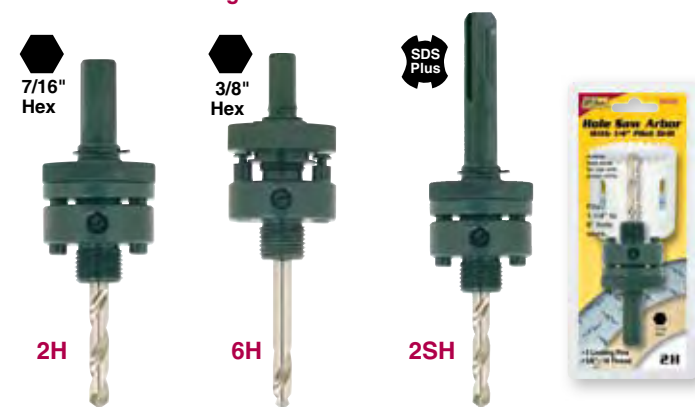

Carded - 1 per card Fits 1-1/4" - 6" Hole Saws

Product	Item	Shank Size	Box/Case	HSD1 Qty.	HSD3 Qty.
28102	2H	7/16" - Hex	4 / 16	1	1
28106	6H	3/8" - Hex	4 / 16	1	1
28109*	2SH	SDS Plus Shank	1 / 12		

Bulk - 30 Arbors per box

28141	2H	7/16" - Hex	1 / 4
28144	6H	3/8" - Hex	1 / 4

* To be used in SDS Plus style drills that have a rotary drilling option. **Not for hammer drilling.**

1/4" Pilot Drills



- High-speed steel, 118° split point.
- Precision-ground bright finish.
- 3 flat sides for set screws.

Carded - 1 drill per card

Product	Length	Description	Box/Case	HSD1 Qty.	HSD3 Qty.
28110	3-1/16"	1 Flat Side	6 / 48	1	1
28114	4-5/16"	3 Flat Sides	6 / 48	1	1

Envelope - 12 drills per envelope

Product	Length	Description	Box/Case
28111	3-1/16"	1 Flat Side	12 / 72
28115	4-5/16"	3 Flat Sides	12 / 72

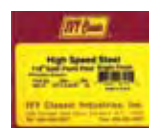

Bulk - 48 drills per box

Product	Length	Description	Box/Case
28132	3-1/16"	1 Flat Side	1 / 4
28136	4-5/16"	3 Flat Sides	1 / 4



Arbor Adapter

Adapts 1H, 4H, 5H & 1SH to fit hole saws 1-1/4" to 6".



Carded - 1 adapter per card

Product	Adapts	Box / Case	HSD1 Qty.	HSD3 Qty.
28112	1/2" - 20 thread to 5/8" - 18	6 / 24	1	1

Bulk - 48 adapters per jar

28150	1/2" - 20 thread 8 to 5/8" - 1	1 / 4
-------	--------------------------------	-------



Cobalt Advantedge

blades are specially designed for heavy-duty cutting in most machinable materials, including stainless and mild steels, non-ferrous metals, plastic and wood.





Bi-Metal Hole Saw Kits

Bi-Metal Hole Saw Kits

- Bi-metal construction with an M-3 cutting edge.
- Variable pitch, positive rake tooth design (4 - 6 TPI).
- 1-1/2" cutting depth cuts through 2 x 4s.
- Kits come in a sturdy plastic case and contain the most popular sizes for the professional.

Cobalt
Advantedge



8 Pc. Electrician Hole Saw Kit

Contains bi-metal hole saws:
7/8", 1-1/8", 1-3/8", 1-3/4", 2"
& 2-1/2".
Contains arbors: 1H & 2H.

Product	Box/Case
28116	1 / 5



8 Pc. Plumbers Hole Saw Kit

Contains bi-metal hole saws:
3/4", 7/8", 1-1/8", 1-1/2",
1-3/4" & 2-1/4".
Contains arbors: 1H & 2H.

Product	Box/Case
28118	1 / 5



11 Pc. Maintenance Hole Saw Kit

Contains bi-metal hole saws:
3/4", 7/8", 1-1/8", 1-3/8", 1-1/2",
1-3/4", 2", 2-1/4", & 2-1/2".
Contains arbors: 1H & 2H.

Product	Box/Case
28120	1 / 5



8 Pc. Locksmiths Hole Saw Kit

Contains bi-metal hole saws:
7/8", 1", 1-1/4", 1-1/2", 1-3/4"
& 2-1/8".
Contains arbors: 2H & 4H.

Product	Box/Case
28117	1 / 5



Bi-Metal Lock Installation Kit for Steel & Wood Doors

- Guide template for easy & exact drilling.
- For 1-3/8" & 1-3/4" thick doors.
- For 2-3/8" and 2-3/4" backsets.
- Includes 1" & 2-1/8" bi-metal hole saws.
- Arbor with HSS pilot drill fits both hole saws.



Carded Product	Description	Box/Case
27001	Bi-Metal Lock Installation Kit With Guide	6 / 24



Lock Installation Kit for Wood Doors

- Guide template for easy & exact drilling.
- For 1-3/8" & 1-3/4" thick wood doors.
- For 2-3/8" and 2-3/4" backsets.
- 1" & 2-1/8" carbon-steel hole saws.
- D type arbor with carbon-steel pilot drill fits both hole saws.



Carded Product	Description	Box/Case
27003	Lock Installation Kit With Guide	6 / 24



5 Pc. Carbon-Steel Hole Saw Set

- Cuts wood, plastic & composition materials.
- Precision-ground teeth for smooth cuts.

Contains :
1-1/4", 1-1/2", 2", 2-1/8" hole saws,
3/8" hex arbor with 1/4" pilot drill.



Carded Product	Description	Box/Case
27006	5 Pc. Set	6 / 24

Lock Installation Kit for Wood Doors

- 2-1/8" Steel Hole Saw
- 3/8" Heavy-Duty Mandrel
- 1" Swift Bore® Spade Bit



Carded Product	Description	Box/Case
27002	3 Pc. Lock Kit	6 / 24

One-Piece Bi-Metal Hole Saws



One Piece Bi-Metal Hole Saws



Convenient, one-piece hole saws save arbor changes.

- Bi-Metal construction with M-3 cutting edge.
- Variable pitch, positive rake tooth design.
- 1-1/2" cutting depth cuts through 2x4s.
- Solid alloy-steel back reduces vibration.



Cobalt Advantedge



D HSD2 - One Piece Hole Saw Display



Size: 18"W, 27"H
Note: Also contains six each:
28110, 28114 - Pilot Drills

Carded

Product	Diameter	Pipe Tap Size	Pipe Ent. Size	Box/Case	Qty.
27010	5/8"			2 / 12	
27012	3/4"	1/2"	3/8"	2 / 12	1
27014	7/8"	3/4"	1/2"	2 / 12	1
27016	1"			2 / 12	1
27018	1-1/8"	1"	3/4"	2 / 12	1
27020	1-1/4"			2 / 12	1
27022	1-3/8"		1"	2 / 12	1
27024	1-1/2"	1-1/4"		2 / 12	1
27026	1-5/8"			2 / 12	1
27028	1-3/4"	1-1/2"	1-1/4"	2 / 12	1
27030	1-7/8"			2 / 12	1
27032	2"		1-1/2"	2 / 12	1
27034	2-1/8"			2 / 12	1
27036	2-1/4"	2"		2 / 12	1
27038	2-3/8"			2 / 12	
27040	2-1/2"		2"	2 / 12	1
27042	2-5/8"	2-1/2"		2 / 12	
27044	2-3/4"			2 / 12	
27046	2-7/8"			2 / 12	
27048	3"		2-1/2"	2 / 12	1
27050	3-1/8"			1 / 12	
27052	3-1/4"	3"		1 / 12	
27054	3-3/8"			1 / 12	
27056	3-1/2"			1 / 12	1
27058	3-5/8"		3"	1 / 12	
27060	3-3/4"	3-1/2"		1 / 12	
27062	3-7/8"			1 / 12	
27064	4"			1 / 12	
27066	4-1/8"		3-1/2"	1 / 12	1
27068	4-1/4"	4"		1 / 12	
27070	4-3/8"			1 / 12	
27072	4-1/2"		4"	1 / 12	
27076	4-3/4"	4-1/2"		1 / 12	
27080	5"			1 / 12	
27088	5-1/2"		5"	1 / 12	
27092	5-3/4"			1 / 12	
27096	6"			1 / 12	

Use 1/4" x 3-1/16" Pilot Drill - 28110 (See page 13)
For Hole Saw Sizes 5/8" - 3"
Use 1/4" x 4-5/16" Pilot Drill - 28114 (See page 13)
For Hole Saw Sizes 3-1/8" - 6"

Bi-Metal Lock Installation Kit for Steel & Wood Doors



- 1" Bi-Metal Hole Saw
- 2-1/8" Bi-Metal Hole Saw
- 1/4" Pilot Bit



Cobalt Advantedge

Carded Product	Box/Case
27000	2 / 6

Cobalt Advantedge



Heavy-duty cutting in most machinable materials including, stainless and mild steels, non-ferrous metals, plastic and wood.



Carbide Circular Saw Blades

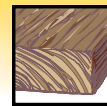

Swift Cut® Plus

General Purpose Contractor & DIYers

- C2 tungsten carbide alloy teeth.
- Designed for framing, crosscutting and ripping of plywood, composition board, and hard and soft woods.
- Alternate top bevel ground teeth.



Carbide Blades

Display Box - 25 blades per box

Product	Diameter	Teeth	Arbor	Kerf	Hook	Box/Case
36103	7-1/4"	20	5/8" <	.095"	20°	25 / 75
36105	7-1/4"	24	5/8" <	.095"	20°	25 / 75
36107	7-1/4"	40	5/8" <	.095"	20°	25 / 75
36109	7-1/4"	60	5/8" <	.095"	15°	25 / 50

Carded

Product	Diameter	Teeth	Arbor	Kerf	Hook	Box/Case
36102	7-1/4"	20	5/8" <	.095"	20°	10 / 50
36104	7-1/4"	24	5/8" <	.095"	20°	10 / 50
36106	7-1/4"	40	5/8" <	.095"	20°	10 / 50
36108	7-1/4"	60	5/8" <	.095"	15°	5 / 25
36110	8-1/4"	24	5/8" <	.102"	10°	5 / 25
36112	8-1/4"	40	5/8" <	.102"	10°	5 / 25
36116	10"	28	5/8"	.110"	22°	5 / 25
36118	10"	40	5/8"	.110"	15°	5 / 25
36120	10"	60	5/8"	.110"	10°	5 / 25
36122	12"	60	1"	.110"	10°	5 / 25

Premium Swift Cut®

Heavy-Duty Professional Quality

- Large C3 tungsten carbide alloy teeth.
- Designed for fast, super-smooth cutting in plywood, composition board, and hard and soft woods.
- Fully hardened body with Rockwell Hardness 40 - 43 HRC.
- Expansion slots reduce heat buildup and eliminate warping.
- Alternate top bevel ground teeth.

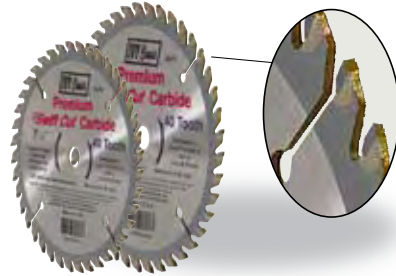

Carbide Blades

Carded

Product	Diameter	Teeth	Arbor	Kerf	Hook	Box/Case
36076	7-1/4"	40	5/8" <	.110"	10°	5 / 15
36078	7-1/4"	60	5/8" <	.110"	10°	5 / 15
36080	8-1/4"	40	5/8" <	.118"	10°	5 / 15
36082	8-1/4"	60	5/8" <	.118"	10°	5 / 15
36084	10"	60	5/8"	.126"	10°	5 / 15
36086	10"	80	5/8"	.126"	10°	4 / 12
36090	12"	80	1"	.126"	10°	2 / 6

Private Label Blades



- High quality carbide blades with a private label at very competitive prices.

Prod.	Dia.	Teeth	Box
Swift Cut® Plus - C2 Tungsten Carbide			
36105PL	7-1/4"	24	250
36107PL	7-1/4"	40	250

Prod.	Dia.	Teeth	Box
RipCross® - C3 Tungsten Carbide			
36203PL	7-1/4"	24	250
36205PL	7-1/4"	40	250

Minimum order is 250 blades per SKU.

*There is a one time \$30.00 plate set-up fee.

Roofers Carbide Blade



- Designed for rough cutting nail-embedded plywood, tar paper and shingles.
- Tungsten carbide with triple chip grind.



Carded

Product	Dia.	Teeth	Arbor	Kerf	Hook	Box/Case
36034	7-1/4"	14	5/8" <	.098"	-6°	5 / 25

Nail Cutting Carbide



- Designed for cutting used lumber with embedded nails.
- Tungsten carbide with triple chip grind.



Carded

Product	Dia.	Teeth	Arbor	Kerf	Hook	Box/Case
36032	7-1/4"	14	5/8" <	.098"	-6°	5 / 25

Rip Cross®

Thin Kerf Carbide



- Large C3 tungsten carbide alloy teeth.
- Alternate top bevel ground teeth.
- Thin Kerf reduces drag and friction.
- Anti-kickback design ensures consistent chip removal.
- Designed for smooth, efficient ripping and crosscutting in plywood, composition board, and hard and soft woods.
- Fully hardened body with Rockwell Hardness 40 - 43 HRC.



Thin Kerf Carbide

Display Box - 25 blades per box

Product	Dia.	Teeth	Arbor	Kerf	Hook	Box/Case
36203	7-1/4"	24	5/8" <	.067"	20°	25 / 75
36205	7-1/4"	40	5/8" <	.067"	20°	25 / 75
36207	7-1/4"	60	5/8" <	.067"	15°	25 / 50

Carded

Product	Dia.	Teeth	Arbor	Kerf	Hook	Box/Case
36202	7-1/4"	24	5/8" <	.067"	20°	10 / 50
36204	7-1/4"	40	5/8" <	.067"	20°	5 / 50
36206	7-1/4"	60	5/8" <	.067"	15°	5 / 50
36210	8-1/4"	40	5/8" <	.079"	20°	4 / 20
36216	10"	40	5/8"	.083"	20°	4 / 20
36218	10"	60	5/8"	.083"	15°	4 / 20
36226	12"	80	1"	.106"	15°	2 / 10

Thin Kerf Carbide - Small Diameter

Carded

Prod.	Dia.	Teeth	Arbor	Kerf	Hook	Box/Case
36170	3-3/8"	24	15mm	.060"	20°	1 / 5
36171	4"	24	20mm	.063"	20°	1 / 5
36172	4-3/8"	24	20mm	.063"	20°	1 / 5
36173	4-1/2"	36	20mm, 3/8"	.063"	20°	1 / 5
36174	5-3/8"	24	20mm, 10mm	.063"	20°	1 / 5
36175	5-1/2"	24	5/8", 1/2"	.063"	20°	1 / 5
36176	6"	20	20mm, 1/2"	.063"	20°	1 / 5
36177	6"	40	20mm, 1/2"	.063"	15°	1 / 5
36180	6-1/2"	20	5/8" <	.067"	20°	1 / 5
36181	6-1/2"	40	5/8" <	.067"	15°	1 / 5

CBD8- Thin Kerf Small Diameter Blade Display

Size: 22"W, 25"H
Note: Contains three cards of each blade listed above.



Decking Carbide



- Cuts pressure-treated lumber.
- Silicone coated to reduce friction and residue buildup.
- Kerf: .079", Hook: 20°.



Product	Dia.	Teeth	Arbor	Box/Case
---------	------	-------	-------	----------

Bulk - 25 blades per box

36031	7-1/4"	24	5/8" <	25 / 75
-------	--------	----	--------	---------

Carded

36030	7-1/4"	24	5/8" <	5 / 25
-------	--------	----	--------	--------



Aluminum & Plastic Blades



- Steel blade designed for cutting light-gauge aluminum (up to 1/8"), plastic & vinyl siding.
- Precision-ground with no set for smoother cuts.

Product	Dia.	Teeth	Arbor	Box/Case
---------	------	-------	-------	----------

Carded

35050	7-1/4"	186	5/8" <	5 / 25
-------	--------	-----	--------	--------

35056	10"	248	5/8"	5 / 25
-------	-----	-----	------	--------

Plywood Veneer Steel Blades

- Smooth, clean cutting of plywood & veneer.



Product	Dia.	Teeth	Arbor	Box/Case
---------	------	-------	-------	----------

Bulk

35030	7-1/4"	186	5/8" <	25 / 75
-------	--------	-----	--------	---------

Carded

35031	7-1/4"	186	5/8" <	10 / 50
-------	--------	-----	--------	---------

35032	8"	200	5/8" <	5 / 25
-------	----	-----	--------	--------

35034	10"	248	5/8"	5 / 25
-------	-----	-----	------	--------



Laser Carbide® Circular Saw Blades



LASER CARBIDE®

Professional & Industrial Applications



- Large C4 industrial tungsten carbide alloy teeth for maximum performance.
- Carbide tooth angle and configuration designed to cut different materials. (Details for each blade below)
- Fully hardened body with Rockwell Hardness 40 - 43 HRC.
- Expansion slots reduce heat buildup & eliminate warping.
- Precision ground tolerances for rigorous industrial use.



■ Laminate & Wood

Designed for chip-free cutting of laminates, Formica®, melamine and crosscutting hardwoods.

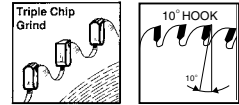

Carded

Product	Dia.	Teeth	Arbor	Kerf	Box/Case
36340	7-1/4"	60	5/8" <	.090"	1 / 5
36346	10"	80	5/8"	.126"	1 / 5
36348	12"	96	1"	.126"	1 / 5

■ Non-Ferrous Blade

Designed for precise cutting of aluminum, brass and other non-ferrous metal bars & extrusions.

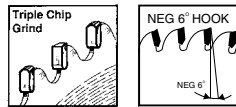

Carded

Product	Dia.	Teeth	Arbor	Kerf	Box/Case
36360	7-1/4"	60	5/8" <	.110"	1 / 5
36366	10"	80	5/8"	.126"	1 / 5
36368	12"	96	1"	.126"	1 / 5

■ Solid Surface & Plastics

For cutting plastics, acrylic sheets, plexiglass & solid surface materials such as Corian® & Fountain Head®.

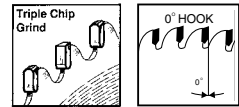

Carded

Product	Dia.	Teeth	Arbor	Kerf	Box/Case
36350	7-1/4"	60	5/8" <	.110"	1 / 5
36356	10"	80	5/8"	.126"	1 / 5
36358	12"	96	1"	.126"	1 / 5

■ Compound Slide Miter

For controlled feed when using compound slide miter or radial arm saw while crosscutting hard or soft woods.

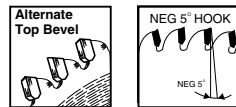

Carded

Product	Dia.	Teeth	Arbor	Kerf	Box/Case
36320	8-1/2"	60	5/8"	.090"	1 / 5
36322	10"	60	5/8"	.090"	1 / 5
36328	12"	60	1"	.090"	1 / 5

■ Precision Miter & Trim

Designed for precision cross-cutting, mitering and fine finishing in hard & soft woods.

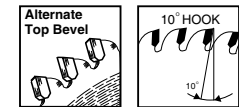

Carded

Product	Dia.	Teeth	Arbor	Kerf	Box/Case
36312	12"	96	1"	.126"	1 / 5
36314	14"	108	1"	.138"	1 / 5

■ Steel Cutting Blade

- C6 carbide for ferrous metal.
- Cuts 1/8" - 1/4" mild steel such as studs, pipe, sheet, angle, channel and more.
- Reduced sparking with less heat buildup.
- Anti-kickback design for safe performance.
- Individually hammer-tensioned steel plates for true run.
- Alternate top bevel with 0° hook.



Carded

Product	Dia.	Teeth	Arbor	Kerf	Box/Case
36385	7-1/4"	36	5/8" <	0.079"	1 / 10

■ Fiber-Cement Blade

- Poly-Crystalline Diamond teeth for maximum cutting life.
- Perfectly tensioned, hardened tool steel plates for flat, true run.
- Flat top grind with 12° hook.

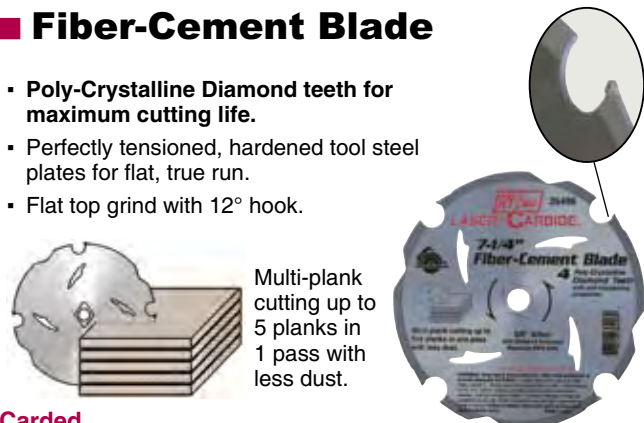

Carded

Product	Dia.	Teeth	Arbor	Kerf	Box/Case
36496	7-1/4"	4	5/8" <	.091"	1 / 10

Circular Saw Blade Displays



Swift Cut® Plus

For framing, ripping & crosscutting of plywood, composition board, and hard and soft woods.

D CBD1

Product	Dia.	Teeth	Qty.
---------	------	-------	------

Carbide

36102	7-1/4"	20	10
36104	7-1/4"	24	10
36106	7-1/4"	40	5
36108	7-1/4"	60	5

Plywood

35031	7-1/4"	186	10
-------	--------	-----	----

All blades have a 5/8" \diamond arbor.

D CBD7

Product	Dia.	Teeth	Qty.
---------	------	-------	------

36110	8-1/4"	24	5
36116	10"	28	5
36118	10"	40	5
36120	10"	60	5

All blades have a 5/8" arbor.



Size:
10"W
39"H

Ripcross® Thin Kerf

Designed for smooth, efficient ripping & crosscutting. Hardened body adds stability. Thin kerf reduces drag and friction.

D CBD2

Product	Dia.	Teeth	Qty.
---------	------	-------	------

Ripcross®

36202	7-1/4"	24	10
36204	7-1/4"	40	5
36206	7-1/4"	60	2
36210	8-1/4"	40	2

Ripcross® Decking

36030	7-1/4"	24	5
-------	--------	----	---

All blades have a 5/8" \diamond arbor.



Size:
10"W
39"H

Premium Swift Cut®

Hardened body adds stability. Large tips stay sharp longer. Expansion slots reduce heat buildup.

D CBD3

Product	Dia.	Teeth	Qty.
---------	------	-------	------

Premium Swift Cut® Carbide

36076	7-1/4"	40	2
36078	7-1/4"	60	2
36080	8-1/4"	40	2
36082	8-1/4"	60	2

Nail Cutting Carbide

36032	7-1/4"	14	2
-------	--------	----	---

All blades have a 5/8" \diamond arbor.



Size:
10"W
39"H

Premium Ripcross®

Hardened body adds stability. Large tips stay sharp longer. Expansion slots reduce heat buildup.

D CBD4

Product	Dia.	Teeth	Qty.
---------	------	-------	------

Ripcross®

36216	10"	40	2
36218	10"	60	2

Premium Swift Cut®

36084	10"	60	2
36086	10"	80	2

All 10" blades have a 5/8" arbor.



Size:
12"W
36"H

IVY Classic LASER CARBIDE®

TCG - Triple Chip Ground Carbide ensures smooth cutting on extremely hard materials.

D CBD5

Product	Dia.	Teeth	Qty.
---------	------	-------	------

Steel Cutting

36385	7-1/4"	36	1
-------	--------	----	---

Solid Surface, Plastics - TCG

36350	7-1/4"	60	1
-------	--------	----	---

Laminate & Wood - TCG

36340	7-1/4"	60	1
-------	--------	----	---

Non-Ferrous Metal - TCG

36360	7-1/4"	60	1
-------	--------	----	---

Fiber Cement

36496	7-1/4"	4	1
-------	--------	---	---

All blades have a 5/8" \diamond arbor.



Size:
10"W
39"H

IVY Classic LASER CARBIDE®

TCG - Triple Chip Ground Carbide ensures smooth cutting on extremely hard materials.

D CBD6

Product	Dia.	Teeth	Qty.
---------	------	-------	------

Solid Surface, Plastics - TCG

36356	10"	80	1
-------	-----	----	---

Laminate & Wood - TCG

36346	10"	80	1
-------	-----	----	---

Non-Ferrous Metal - TCG

36366	10"	80	1
-------	-----	----	---

Compound Slide Miter - ATB

36322	10"	60	1
-------	-----	----	---

All 10" blades have a 5/8" arbor.



Size:
12"W
36"H

Premium Diamond™ Blades

- Ultimate in long life and fast cutting action.
- High concentration of the best quality diamonds ensures accurate cutting edges.
- State-of-the-art manufacturing utilizing the latest sintering and laser technology.



■ Premium Turbo Diamond Blades



Dry and Wet Cutting Continuous Rim

Designed to cut hard materials, granite, natural stone & hard concrete.



Product	Carded	Dia.	Arbor	Rim Width	Rim Height	Box/Case
37050		4"	5/8", 20mm	1.8mm	8mm	1 / 5
37052		4-1/2"	7/8", 5/8"	1.8	8	1 / 5
37054		7"	5/8" <, 7/8"	2.0	8	1 / 5
37055		8"	5/8" <, 7/8"	2.0	8	1 / 5
37056		9"	7/8", 5/8"	2.4	8	1 / 5
37057		10"	5/8"	2.4	8	1 / 5

■ Premium Segmented Diamond Blades



Dry and Wet Cutting

Designed to cut stone, brick, block and concrete.



Product	Carded	Dia.	Arbor	Rim Width	Rim Height	Box/Case
37040		4"	5/8", 20mm	1.5mm	8mm	1 / 5
37042		4-1/2"	7/8", 5/8"	1.5	8	1 / 5
37044		7"	5/8" <, 7/8"	2.0	8	1 / 5
37045		8"	5/8" <, 7/8"	2.0	8	1 / 5
37046		9"	7/8", 5/8"	2.4	8	1 / 5
37047		10"	5/8"	2.4	8	1 / 5

■ Premium Tile Cutting Diamond Blades



Dry and Wet Cutting Continuous Rim

For precise, smooth cutting of ceramic tiles, marble, slate and granite tiles.



Product	Carded	Dia.	Arbor	Rim Width	Rim Height	Box/Case
37060		4"	5/8", 20mm	1.5mm	7mm	1 / 5
37062		4-1/2"	7/8", 5/8"	1.5	7	1 / 5
37064		7"	5/8" <, 7/8"	1.5	7	1 / 5

■ Premium Tile Cutting Diamond Blades



Wet Cutting Continuous Rim

For precise, smooth and accurate cutting. Extremely high diamond concentration gives blade long life.



Product	Carded	Dia.	Arbor	Rim Width	Rim Height	Box/Case
37084		6"	5/8"	1.4mm	6mm	1 / 5
37086		8"	5/8"	1.8	7	1 / 5
37087		10"	5/8"	1.8	7.5	1 / 5

■ Premium Laser Welded



Dry and Wet Cutting Segmented with Pinhole

Maximum cutting depth per pass 2".



Carded General purpose - cuts stone, brick, block & concrete

Product	Carded	Dia.	Arbor	Rim Width	Rim Height	Box/Case
37048		12"	1"	.110"	7mm	1 / 5
37049		14"	1"	.110"	7	1 / 5

Cuts cured concrete, block & brick

Product	Carded	Dia.	Arbor	Rim Width	Rim Height	Box/Case
37023		12"	1"	.110"	7mm	1 / 5
37025		14"	1"	.110"	7	1 / 5

Cuts asphalt & green concrete

Carbide segment for undercutting protection

Product	Carded	Dia.	Arbor	Rim Width	Rim Height	Box/Case
37030		12"	1"	.125"	7mm	1 / 5
37032		14"	1"	.125"	7	1 / 5

Cuts marble, granite & stone

Product	Carded	Dia.	Arbor	Rim Width	Rim Height	Box/Case
37038		12"	1"	.110"	7mm	1 / 5
37039		14"	1"	.110"	7	1 / 5

Cuts paving stone

Product	Carded	Dia.	Arbor	Rim Width	Rim Height	Box/Case
37018		12"	1"	.125"	7mm	1 / 5
37019		14"	1"	.125"	7	1 / 5

Swift Cut® Diamond Blades

- Quality-engineered diamonds, bonding matrix and steel core.
- Outstanding performance at a reasonable price.
- Latest automated manufacturing technology.



Turbo Diamond Blades



Dry and Wet Cutting Continuous Rim

For cutting hard materials, granite, natural stone and hard concrete.



Product	Dia.	Arbor	Rim Width	Rim Height	Box/Case
38050	4"	5/8", 20mm	2mm	7mm	1 / 10
38052	4-1/2"	7/8", 5/8"	2	7	1 / 10
38054	7"	5/8" \diamond, 7/8"	2.3	7	1 / 10
38055	8"	5/8" \diamond, 7/8"	2.6	7	1 / 5
38056	9"	5/8", 7/8"	2.8	7	1 / 5
38057	10"	5/8"	2.8	7	1 / 5

Segmented Diamond Blades



Dry and Wet Cutting

Designed to cut stone, brick, block and concrete.



Product	Dia.	Arbor	Rim Width	Rim Height	Box/Case
38040	4"	5/8", 20mm	1.8mm	7mm	1 / 10
38042	4-1/2"	7/8", 5/8"	1.8	7	1 / 10
38044	7"	5/8" \diamond, 7/8"	2.2	7	1 / 10
38045	8"	5/8" \diamond, 7/8"	2.3	7	1 / 5
38046	9"	5/8", 7/8"	2.5	7	1 / 5
38047	10"	5/8"	2.5	7	1 / 5

Tile Cutting Diamond Blades



Dry and Wet Cutting Continuous Rim

Designed for precise, smooth cutting of ceramic tiles, marble, slate and granite tiles.



Product	Dia.	Arbor	Rim Width	Rim Height	Box/Case
38060	4"	5/8", 20mm	1.8mm	5.5mm	1 / 10
38062	4-1/2"	7/8", 5/8"	1.8	5.5	1 / 10
38064	7"	5/8" \diamond, 7/8"	2.2	6.0	1 / 10

Tuck Pointing Diamond Blades



Dry and Wet Cutting

For tuck pointing and cleaning mortar joints. Ideal for restoration projects.



Product	Dia.	Arbor	Rim Width	Rim Height	Box/Case
38090	4"	7/8", 5/8"	1/4"	7mm	1 / 10
38092	4-1/2"	7/8", 5/8"	1/4"	7	1 / 10
38094	7"	7/8", 5/8"	1/4"	7	1 / 10

Tile Cutting Wet Saw Blades



Wet Cutting Continuous Rim

Smoothly cuts ceramic tiles, marble, slate and granite tiles.



Product	Dia.	Arbor	Rim Width	Rim Height	Box/Case
38084	6"	5/8"	2.2mm	5.5mm	1 / 5
38086	8"	5/8"	2.3	6.0	1 / 5
38087	10"	5/8"	2.5	7.0	1 / 5

Fiber-Cement Diamond Blades



Dry Cutting Continuous Rim

Designed to cut fiber-cement board siding and Hardi board.



Product	Dia.	Arbor	Rim Width	Rim Height	Box/Case
38070	4"	5/8", 20mm	2mm	7mm	1 / 10
38072	4-1/2"	7/8", 5/8"	2	7	1 / 10
38074	7"	5/8" \diamond, 7/8"	2.6	7	1 / 10
38075	10"	5/8"	2.6	7	1 / 10

• NOTE: Dry cutting diamond blades can also be used in wet applications.



Diamond Plus™ Blades

Diamond Plus™

- A highly reliable blade at a lower price for small to medium cutting jobs.
- Latest automated manufacturing technology.

Turbo Diamond Blades



Dry and Wet Cutting Continuous Rim

For cutting hard materials, granite, natural stone and hard concrete.



Carded Product	Dia.	Arbor	Rim Width	Rim Height	Box/Case
38150	4"	5/8", 20mm	2mm	7mm	5 / 20
38152	4-1/2"	7/8", 5/8"	2	7	5 / 20
38154	7"	5/8" <, 7/8"	2.5	7	5 / 20

Tile Cutting Diamond Blades



Dry and Wet Cutting Continuous Rim

Designed for precise, smooth cutting of ceramic tiles, marble, slate and granite tiles.



Carded Product	Dia.	Arbor	Rim Width	Rim Height	Box/Case
38160	4"	5/8", 20mm	1.9mm	5.5mm	5 / 20
38162	4-1/2"	7/8", 5/8"	1.9	5.5	5 / 20
38164	7"	5/8" <, 7/8"	2.2	5.5	5 / 20

Tile Cutting Wet Saw Blades



Wet Cutting Continuous Rim

Smoothly cuts ceramic tiles, marble, slate and granite tiles.



Carded Product	Dia.	Arbor	Rim Width	Rim Height	Box/Case
38184	6"	5/8"	2.2mm	5.5mm	5 / 20
38186	8"	5/8"	2.3	5.5	5 / 20
38187	10"	5/8"	2.5	5.5	5 / 20

Tuck Pointing Diamond Blades



Dry and Wet Cutting Segmented

For tuck pointing and cleaning mortar joints. Ideal for restoration projects.



Carded Product	Dia.	Arbor	Rim Width	Rim Height	Box/Case
38190	4"	7/8", 5/8"	1/4"	7mm	1 / 20
38192	4-1/2"	7/8", 5/8"	1/4"	7	1 / 20
38194	7"	7/8", 5/8"	1/4"	7	1 / 20

▪ NOTE: Dry cutting diamond blades can also be used in wet applications.



Segmented Diamond Blades



Dry and Wet Cutting Segmented

Designed to cut stone, brick, block and concrete.



Carded Product	Dia.	Arbor	Rim Width	Rim Height	Box/Case
38140	4"	5/8", 20mm	1.8mm	7mm	5 / 20
38142	4-1/2"	7/8", 5/8"	1.9	7	5 / 20
38144	7"	5/8" <, 7/8"	2.2	7	5 / 20

DPD - Diamond Plus™ Diamond Blade Display



Size: 22"W, 37"H

Prod.	Dia.	Qty.
Turbo		
38150	4"	5
38152	4½"	3
38154	7"	2
Segmented		
38140	4"	5
38142	4½"	3
38144	7"	2
Tuck Pointing		
38190	4"	1
38192	4½"	1
Tile Cutting		
38160	4"	5
38162	4½"	3
38164	7"	2

Diamond Blade Displays and Hole Saws

D PDD1 - *Swift Cut*[®] Diamond Blade Display



Size: 24"W, 31"H, 5"Depth

Prod.	Dia.	Arbor	Rim Width	Rim Ht.	D Qty.
Swift Cut[®] Turbo Blades					
38050	4"	5/8", 20mm	2mm	7mm	3
38052	4 1/2"	7/8", 5/8"	2	7	2
38054	7"	5/8"◊, 7/8"	2.3	7	2
Swift Cut[®] Segmented Blades					
38040	4"	5/8", 20mm	1.8	7	3
38042	4 1/2"	7/8", 5/8"	1.8	7	2
38044	7"	5/8"◊, 7/8"	2.2	7	2
Swift Cut[®] Tile Cutting Blades					
38060	4"	5/8", 20mm	1.8	5.5	3
38062	4 1/2"	7/8", 5/8"	1.8	5.5	2
38064	7"	5/8"◊, 7/8"	2.2	6.0	2

Includes a **free**, lockable, wooden merchandiser.

D PDD2 - *Premium* Diamond Blade Display



Size: 24"W, 31"H, 5"Depth

Prod.	Dia.	Arbor	Rim Width	Rim Ht.	D Qty.
Premium Turbo Blades					
37050	4"	5/8", 20mm	1.8mm	8mm	2
37052	4 1/2"	7/8", 5/8"	1.8	8	2
37054	7"	5/8"◊, 7/8"	2.0	8	1
Premium Segmented Blades					
37040	4"	5/8", 20mm	1.5	8	2
37042	4 1/2"	7/8", 5/8"	1.5	8	1
37044	7"	5/8"◊, 7/8"	2.0	8	1
Premium Tile Cutting Blades					
37060	4"	5/8", 20mm	1.5	7	2
37062	4 1/2"	7/8", 5/8"	1.5	7	1
37064	7"	5/8"◊, 7/8"	1.5	7	1

Includes a **free**, lockable, wooden merchandiser.

■ Steel Adapters

- Adapts blade arbors to fit machine spindle.
- Check machine used for correct arbor size.



Prod.	Outside D	Inside d	Box/Case
37952	1"	7/8"	10 / 50
37954	1"	5/8"	10 / 50
37956	20mm	5/8"	10 / 50
37957	7/8"	5/8"	10 / 50
37958	Diamond	5/8"	10 / 50

Rotational Speeds for Diamond Blades

Blade Diameter	Maximum Safe Speed (R.P.M.)
4"	15,200
4-1/2"	13,300
7"	8,500
8"	6,800
9"	6,400
10"	6,100
12"	6,300
14"	5,400

Warning: Operating diamond blades at rotational speeds greater than those recommended can cause possible blade damage and subsequent personal injury.

Dry or Wet Cutting:

Note: Dry cutting diamond blades can also be used in wet applications.

■ Diamond Grit Hole Saws

Wet and Dry Cutting

- Vacuum-brazed diamond grit ensures long life.
- Use low rpm with minimal pressure.
- Lubricate with water for cool cutting.
- Slot in hole saw for easy plug removal.
- Overall length 2-3/16".



Rotary Drilling Only



WET DRY



Hex Shank



Porcelain and Hard Tile



Quarry Tile



Granite Tile



Glass



Carded

Prod.	Dia.	Box/Case	D Qty.
37802	3/16"	1 / 5	1
37803	1/4"	1 / 5	1
37804	5/16"	1 / 5	1
37805	3/8"	1 / 5	1
37806	1/2"	1 / 5	1
37807	5/8"	1 / 5	1
37808	3/4"	1 / 5	1
37809	1"	1 / 5	1
37810	1-1/4"	1 / 5	1
37811	1-3/8"	1 / 5	1

D DHS - Diamond Grit Hole Saw Display



Size: 21"W, 16"H



Metal Abrasive Blades and Wheels

Metal Blades & Wheels



- Made of aluminum oxide.
- Cuts steel, angle iron, sheet metal and other ferrous metal products.

■ Metal Cut-Off Blades



For Portable Tools

Product	Diameter	Width	Arbor	Max RPM	Box/Case
Bulk					
40062	4"	3/32"	5/8"	15300	25 / 100
40068	4-1/2"	3/32"	7/8"	13200	25 / 100
40080	6-1/2"	3/32"	5/8" <	9400	25 / 50
40082	7"	3/32"	5/8" <	8600	25 / 100
40084	8"	3/32"	5/8" <	7500	25 / 50
Carded					
40648	6-1/2"	3/32"	5/8" <	9400	10 / 100
40650	7"	3/32"	5/8" <	8600	10 / 100
40652	8"	3/32"	5/8" <	7500	10 / 100



■ Metal/Stainless Steel Thin Cut-Off Blades



Product	Diameter	Width	Arbor	Max RPM	Box/Case
Bulk					
40051	4"	.047"	5/8"	15300	25 / 100
40054	4-1/2"	.047"	7/8"	13200	25 / 100

For Stainless



■ Metal Cut-Off Blades



Product	Diameter	Width	Arbor	Max RPM	Box/Case
Bulk					
For Chop Saws • Do not use on High-Speed Saws					
40088	10"	3/32"	5/8"	6100	10 / 50
40106	12"	3/32"	1"	5100	10 / 50
40108	14"	3/32"	1"	4400	10 / 50
For High-Speed Power Saws • Heavy-duty reinforced wheel					
40172	12"	1/8"	1"	6300	10 / 50
40174	12"	1/8"	20mm	6300	10 / 50
40178	14"	1/8"	1"	5400	10 / 50
40180	14"	1/8"	20mm	5400	10 / 50



■ Metal Depressed Center Wheels

- Designed for constant, all-purpose grinding & cutting.



Product	Diameter	Width	Arbor	Max RPM	Box/Case
Bulk					
40220	4"	1/8"	5/8"	15300	25 / 100
40222	4"	1/4"	5/8"	15300	25 / 100
40224	4-1/2"	1/8"	7/8"	13200	25 / 100
40226	4-1/2"	1/4"	7/8"	13200	25 / 100
40232	7"	1/8"	7/8"	8600	25 / 100
40234	7"	1/4"	7/8"	8600	25 / 100
With Threaded Hubs					
40244	4-1/2"	1/8"	5/8"-11 thread	13200	10 / 100
40246	4-1/2"	1/4"	5/8"-11 thread	13200	10 / 100
40252	7"	1/8"	5/8"-11 thread	8600	10 / 100
40254	7"	1/4"	5/8"-11 thread	8600	10 / 100
40256	9"	1/8"	5/8"-11 thread	6600	10 / 100
40258	9"	1/4"	5/8"-11 thread	6600	10 / 100



Masonry Blades & Wheels

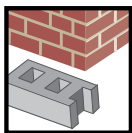

- Made of silicon carbide.
- Cuts brick, concrete block, slate, tile and other masonry products.



■ Masonry Cut-Off Blades



For Portable Tools

Product	Diameter	Width	Arbor	Max RPM	Box/Case
Bulk					
41010	4"	1/8"	5/8"	15300	25 / 100
41012	4-1/2"	1/8"	7/8"	13200	25 / 100
41018	6-1/2"	1/8"	5/8"◇	9400	25 / 50
41020	7"	1/8"	5/8"◇	8600	25 / 100
41022	8"	1/8"	5/8"◇	7500	25 / 50
Carded					
41648	6-1/2"	1/8"	5/8"◇	9400	10 / 100
41650	7"	1/8"	5/8"◇	8600	10 / 100
41652	8"	1/8"	5/8"◇	7500	10 / 100



■ Masonry Cut-Off Blades



Bulk

Product	Diameter	Width	Arbor	Max RPM	Box/Case
For Chop Saws • Do not use on High-Speed Saws					
41024	10"	1/8"	5/8"	6100	10 / 50
41030	12"	1/8"	1"	5100	10 / 50
41032	14"	1/8"	1"	4400	10 / 50
For High-Speed Power Saws • Heavy-duty reinforced wheel					
41050	12"	1/8"	1"	6300	10 / 50
41056	14"	1/8"	1"	5400	10 / 50



■ Masonry Depressed Center Wheels



Bulk • Designed for constant, all-purpose grinding & cutting.

Product	Diameter	Width	Arbor	Max RPM	Box/Case
41250	4"	1/8"	5/8"	15300	25 / 100
41252	4"	1/4"	5/8"	15300	25 / 100
41254	4-1/2"	1/8"	7/8"	13200	25 / 100
41256	4-1/2"	1/4"	7/8"	13200	25 / 100
41262	7"	1/8"	7/8"	8600	25 / 100
41264	7"	1/4"	7/8"	8600	25 / 100
With Threaded Hubs					
41294	4-1/2"	1/8"	5/8"-11 thread	13200	10 / 100
41296	4-1/2"	1/4"	5/8"-11 thread	13200	10 / 100
41302	7"	1/8"	5/8"-11 thread	8600	10 / 100
41304	7"	1/4"	5/8"-11 thread	8600	10 / 100
41306	9"	1/8"	5/8"-11 thread	6600	10 / 100
41308	9"	1/4"	5/8"-11 thread	6600	10 / 100





Abrasive Blade and Wheel Displays



Metal Blades & Wheels

D MET1 - Cut-Off & Grinding



Size: 28"W, 29"H

Prod.	Dia.	Width	Arbor	Display Qty.
Cut-Off Blades				
40080	6-1/2"	3/32"	5/8" <	25
40082	7"	3/32"	5/8" <	25
40084	8"	3/32"	5/8" <	25
Grinding Wheels				
40232	7"	1/8"	7/8"	5
40234	7"	1/4"	7/8"	5
40252	7"	1/8"	5/8-11	5
40254	7"	1/4"	5/8-11	5
40256	9"	1/8"	5/8-11	5
40258	9"	1/4"	5/8-11	5

D MET2 - Metal Chop Saw & High-Speed Blades



Size: 18"W, 18"H, 13"Depth

Prod.	Dia.	Width	Arbor	Display Qty.
Chop Saw Blades				
40088	10"	3/32"	5/8"	10
40106	12"	3/32"	1"	10
40108	14"	3/32"	1"	10
High-Speed Power Saw Blades				
40172	12"	.145"	1"	10
40178	14"	.145"	1"	10

D MET3 - Metal Cut-Off & Grinding Wheels



Size: 20"W, 15"H

Prod.	Dia.	Width	Arbor	Display Qty.
Cut-Off Wheels				
40051	4"	.047	5/8"	25
40054	4-1/2"	.047	7/8"	25
40062	4"	3/32"	5/8"	25
40068	4-1/2"	3/32"	7/8"	25
Grinding Wheels				
40220	4"	1/8"	5/8"	25
40222	4"	1/4"	5/8"	25
40224	4-1/2"	1/8"	7/8"	25
40226	4-1/2"	1/4"	7/8"	25
40244	4-1/2"	1/8"	5/8-11	5
40246	4-1/2"	1/4"	5/8-11	5

Masonry Blades & Wheels

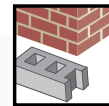

D MAS1 - Cut-Off & Grinding



Size: 28"W, 29"H

Prod.	Dia.	Width	Arbor	Display Qty.
Cut-Off Blades				
41018	6-1/2"	1/8"	5/8" <	25
41020	7"	1/8"	5/8" <	25
41022	8"	1/8"	5/8" <	25
Grinding Wheels				
41262	7"	1/8"	7/8"	5
41264	7"	1/4"	7/8"	5
41302	7"	1/8"	5/8-11	5
41304	7"	1/4"	5/8-11	5
41306	9"	1/8"	5/8-11	5
41308	9"	1/4"	5/8-11	5

D MAS2 - Masonry Chop Saw & High-Speed Blades



Size: 18"W, 18"H, 13"Depth

Prod.	Dia.	Width	Arbor	Display Qty.
Chop Saw Blades				
41024	10"	1/8"	5/8"	10
41030	12"	1/8"	1"	10
41032	14"	1/8"	1"	10
High-Speed Power Saw Blades				
41050	12"	.145"	1"	10
41056	14"	.145"	1"	10

D MAS3 - Masonry Cut-Off & Grinding Wheels



Size: 20"W, 15"H

Prod.	Dia.	Width	Arbor	Display Qty.
Cut-Off Wheels				
41010	4"	1/8"	5/8"	25
41012	4-1/2"	1/8"	7/8"	25
Grinding Wheels				
41250	4"	1/8"	5/8"	25
41252	4"	1/4"	5/8"	25
41254	4-1/2"	1/8"	7/8"	25
41256	4-1/2"	1/4"	7/8"	25
41294	4-1/2"	1/8"	5/8-11	10
41296	4-1/2"	1/4"	5/8-11	10



Wire Brushes and Wheels



1" Crimped Wire End Brush

- For controlled removal of rust, dirt, scale, paint or welds in hard-to-reach places.
- Tempered carbon-steel for long life.



Carded Prod.	Size	Shank	Trim Length	Wire Gauge	Max RPM	Box/Case
39035	1"	1/4"	1"	.012	20000	5 / 25

3" Knot Wire Cup Brush

- For heavy-duty removing of rust, dirt, scale, paint or welds from flat surfaces.
- Precision balanced to eliminate vibration.
- Tempered carbon steel for long life.



Carded Prod.	Size	Arbor	Trim Length	Wire Gauge	Max RPM	Box/Case
39038	3"	5/8" - 11	7/8"	.020	12500	5 / 25

3" Crimped Wire Cup Brush

- For removing rust, dirt, scale, paint or welds from flat surfaces.
- Precision balanced to eliminate vibration.
- Tempered carbon steel for long life.



Carded Prod.	Size	Arbor	Trim Length	Wire Gauge	Max RPM	Box/Case
39041	3"	5/8" - 11	13/16"	.012	12500	5 / 25

4" Cable Twist Wire Wheel

- For heavy-duty removal of rust, dirt, scale, paint.
- For edge blending and weld preparation.
- Tempered carbon steel for long life.

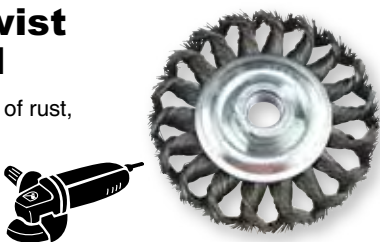

Carded Prod.	Size	Arbor	Trim Length	Wire Gauge	Max RPM	Box/Case
39047	4"	5/8" - 11	1"	.020"	12500	5 / 25

Arbor Adapters

Carded Product	Adapts	Box/Case
Angle Grinder Adapter		
39091	5/8" - 11 to M10 x 1.25mm	5 / 25
39092	5/8" - 11 to M10 x 1.5mm	5 / 25
Drill Adapter		
39093	1/2" Arbor Hole to 1/4" Shank	5 / 25



Crimped Wire Wheel Brushes

- For removing rust, dirt, scale, paint or welds.
- Tempered carbon steel for long life.



Carded Prod.	Size	Wire Gauge	Arbor	Face Width	Max RPM	Box/Case
39050	3"	Coarse - .012"	1/2 - 3/8"	3/8"	4500	5 / 25
39051	3"	Fine - .008"	1/2 - 3/8"	3/8"	4500	5 / 25

Bench Grinder Wheels

39056	6"	Coarse - .012"	5/8 - 1/2"	9/16"	4500	5 / 25
39057	6"	Fine - .008"	5/8 - 1/2"	9/16"	4500	5 / 25
39058	8"	Coarse - .012	5/8 - 1/2"	5/8"	3750	5 / 25

30 Pc. Assorted Crimped Wire Brushes/Wheels

- Brass coated steel reduces wire breakage for longer life.
- Individual wheels are bar coded.



Coarse wire size - .012"
Fine Wire Size - .008"

Contains:

Wire Wheels
4 - 2 1/2" Coarse
2 - 2 1/2" Fine
4 - 3" Coarse
2 - 3" Fine

Cup Brushes

8 - 1 3/4" Coarse
2 - 1 3/4" Fine
6 - 2 3/4" Coarse
2 - 2 3/4" Fine

Product	Description	Max RPM	Box/Case
39080	30 Pc. Wire Brush/Wheel Asst.	4500	1 / 5

7 Pc. Professional Brush/Wheel Set

Contains:

2 3/4" Knotted Wire Cup Brush
2 3/4" Crimped Wire Cup Brush
4" Stringer Bead Wire Wheel
4" Cable Twist Wire Wheel
4 x 16 Row Wire Brush
5/8" - 11 to M10 x 1.25mm Adapter
5/8" - 11 to M10 x 1.5mm Adapter



Product	Description	Max RPM	Box/Case
39084	7 Pc. Pro Brush/Wheel Set	12500	5 / 25

4 Pc. DIY Brush/Wheel Set

Contains:

3/4" End Brush
2" Crimped Wire Cup Brush
3" Crimped Wire Wheel
3" Poly Abrasive Wheel - removes rust & paint

Prod.	Desc.	Max RPM	Box/Case
39083	4 Pc. DIY Set	4500	5 / 25



Zirconia Flap Discs Type 29 (Angled Design)



Flex-Abrasive®

Quality coated abrasives with superior cutting performance.



- Zirconia alumina discs last 20x longer and remove material 3x faster than resin discs.
- For metal fabrication, blending welds, deburring, cleaning, stripping and finishing.
- Combines the grinding capabilities of a depressed center wheel and the finishing characteristics of a fiber disc thereby eliminating the switching of tools.
- Angled design works at 10° - 25° angle.

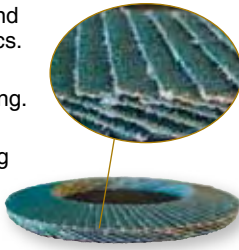

5 per Box - each disc is also barcoded for individual sale.

Product	Dia.	Arbor	Grit	Box/Case	Qty.
42200	4"	5/8"	36 - Extra Coarse	10 / 50	5
42201	4"	5/8"	60 - Coarse	10 / 50	5
42202	4"	5/8"	80 - Medium	10 / 50	5
42203	4"	5/8"	120 - Fine	10 / 50	5
42206	4½"	7/8"	36 - Extra Coarse	10 / 50	5
42207	4½"	7/8"	60 - Coarse	10 / 50	5
42208	4½"	7/8"	80 - Medium	10 / 50	5
42209	4½"	7/8"	120 - Fine	10 / 50	5
42218	7"	7/8"	36 - Extra Coarse	5 / 25	2
42219	7"	7/8"	60 - Coarse	5 / 25	2
42220	7"	7/8"	80 - Medium	5 / 25	2
42221	7"	7/8"	120 - Fine	5 / 25	2

D FDD - Zirconia Flap Disc Display



Size: 25"W, 19"H

Resin Cloth Sanding Belts - X Wt. Aluminum Oxide



Wood



Metal



- Designed for high sanding performance and extra long life.
- For sanding and finishing wood, metal, plastic & fiberglass.
- Ideal for blending welds.
- Diagonal butt joint eliminates the "splice bump."
- Bi-directional sanding for long life.

10 per Box - each belt is also barcoded for individual sale.

Product	Size	Grit	Box/Case
43050	3" x 18"	36 - Extra Coarse	10 / 50
43052	3" x 18"	50 - Coarse	10 / 50
43054	3" x 18"	80 - Medium	10 / 50
43056	3" x 18"	120 - Fine	10 / 50
43060	3" x 21"	36 - Extra Coarse	10 / 50
43062	3" x 21"	50 - Coarse	10 / 50
43064	3" x 21"	80 - Medium	10 / 50
43066	3" x 21"	120 - Fine	10 / 50
43070	3" x 24"	36 - Extra Coarse	10 / 50
43072	3" x 24"	50 - Coarse	10 / 50
43074	3" x 24"	80 - Medium	10 / 50
43076	3" x 24"	120 - Fine	10 / 50
43100	4" x 24"	36 - Extra Coarse	10 / 50
43102	4" x 24"	50 - Coarse	10 / 50
43104	4" x 24"	80 - Medium	10 / 50
43106	4" x 24"	120 - Fine	10 / 50

■ Resin Fiber Discs



Metal Finishing & Paint Stripping

- Aluminum oxide bonded to heavy-duty fiber backing.
- For metal surface finishing, blending welds, deburring and paint stripping.

Use only with backing pad and nut. (See below.)

Carded - 5 discs per card

Product	Dia.	Arbor	Grit	Box/Case	Qty.
42300	4"	5/8"	24 - Extra Coarse	10 / 50	5
42301	4"	5/8"	36 - Coarse	10 / 50	5
42302	4"	5/8"	50 - Medium	10 / 50	5
42303	4"	5/8"	80 - Fine	10 / 50	5
42306	4½"	7/8"	24 - Extra Coarse	10 / 50	5
42307	4½"	7/8"	36 - Coarse	10 / 50	5
42308	4½"	7/8"	50 - Medium	10 / 50	5
42309	4½"	7/8"	80 - Fine	10 / 50	5
42324	7"	7/8"	24 - Extra Coarse	10 / 50	5
42325	7"	7/8"	36 - Coarse	10 / 50	5
42326	7"	7/8"	50 - Medium	10 / 50	5
42327	7"	7/8"	80 - Fine	10 / 50	5

D RFD - Resin Fiber Disc Display
Size: 24"W x 19"H



■ Rubber Backing Pads

- For using sanding discs with angle grinders.



Carded

Product	Diameter	Arbor	Box/Case
42390	4"	M10 x 1.25mm Locking Nut	5 / 25
42391	4-1/2"	5/8" - 11 Locking Nut	5 / 25
42392	7"	5/8" - 11 Locking Nut	5 / 25

■ Adjustable Grinder Pin Wrench

- Adjusts from 5/8" - 2" (15 - 52mm) to fit all angle grinders.
- Stair-step cutout in the handle can be used as a wrench for 3/8" - 3/4" (10 - 19 mm) nuts.
- Slotted screwdriver tip at end of handle.

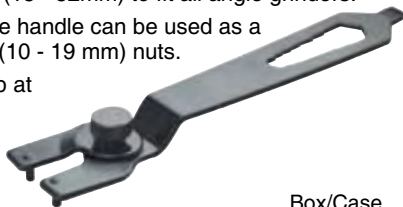

Carded

Product	Description	Box/Case
18119	Adjustable Grinder Pin Wrench	5 / 25

Flex-Abrasive®

Quality coated abrasives with superior cutting performance.

■ 5" Random Orbital Sanding Discs Hook and Loop



Wood Metal



- Aluminum oxide grain.
- For paint stripping, light deburring and finishing.
- Attaches with hook and loop system.

Carded - 5 discs per card

Product	Dia.	Grit	Box/Case	Qty.
42370	5" - 8 Hole	60 - Extra Coarse	10 / 50	5
42371	5" - 8 Hole	80 - Coarse	10 / 50	5
42372	5" - 8 Hole	120 - Medium	10 / 50	5
42373	5" - 8 Hole	150 - Fine	10 / 50	5
42374	5" - 8 Hole	220 - Extra Fine	10 / 50	5

D OSD - Orbital Sanding Disc Display
Size: 22"W x 12"H



■ Buffing Wheels

- Concentrically stitched cotton muslin - 30 ply.
- Buffs and polishes wood and metal.

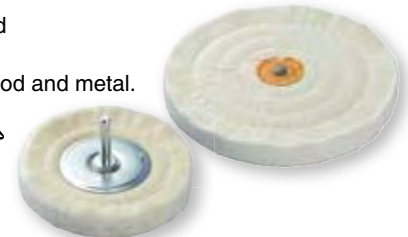

Carded

Product	Description	Arbor	Pile Ht.	Box/Case
39120	4"	1/2"	1/2" - 1"	5 / 25
39121	6"	1/2"	1/2" - 1"	5 / 25
39125	4"	1/4" Spindle	1/2" - 1"	5 / 25

For 39120 and 39121 use Arbor Adapter 39093 on page 27.

■ Wool Bonnets

- Drawstring attaches to the backup pad of the portable polishing tool.
- Balanced to reduce vibration.
- For polishing cars and boats.

Carded

Product	Diameter	Box/Case
39131	5"	5 / 25
39132	6"	5 / 25
39133	7"	5 / 25





Carbide Grit Edge Blades and Saws

Carbide Grit Edge Hole Saws

- 1" cutting depth.
- Cuts ceramic tile, marble & fiberglass.
- Continuous rim of carbide grit ensures smooth cutting.



Made in
U.S.A.

Carded Product	Description	Box/Case
26720	1-1/4" Hole Saw	4 / 24
26722	1-3/8" Hole Saw	4 / 24
26728	1-3/4" Hole Saw	4 / 24
26732	2" Hole Saw	2 / 12
26740	2-1/2" Hole Saw	2 / 12



Carbide Grit Edge Hole Saw Kit

- Kit includes carbide grit hole saw, 3/8" mandrel and carbide masonry pilot bit.

Carded Product	Description	Box/Case
26620	1-1/4" Hole Saw Kit	4 / 24
26622	1-3/8" Hole Saw Kit	4 / 24
26628	1-3/4" Hole Saw Kit	4 / 24
26632	2" Hole Saw Kit	2 / 12
26640	2-1/2" Hole Saw Kit	2 / 12



Arbor with Carbide Pilot

- Heavy-duty mandrel with carbide masonry pilot bit. Fits all IVY Classic carbide grit hole saws.

Carded Product	Description	Box/Case
26600	3/8" Carbide Mandrel	4 / 24



Carbide Grit Jig Saw Blades

- Exceptionally smooth finish in tight radius cutting.



Ceramic Tile



Metal



Fiberglass



Made in U.S.A.

Standard Jig Saw Blades



Carded Product	Fits	Length	Box/Case
26504	Universal Style	3"	5 / 50



Bosch® Style Jig Saw Blades



Carded Product	Fits	Length	Box/Case
26502	Bosch® Style	3"	5 / 50



Carbide Grit Reciprocating Saw Blade

- Fits 1/2" Universal shank reciprocating saws.



Ceramic Tile



Metal



Cast Iron



Product	Item	Length	Box/Case
Carded - 1 per card			
26509	R80GC	8"	5 / 50
Pouched - 5 per pouch			
26508	R80GP	8"	1 / 10
Bulk - 50 per pack			
26507	R80GB	8"	50 / 250



Carbide Grit Hacksaw Blade



Ceramic Tile



Metal

- Ideal for smooth finish straight cutting.
- Extra wide blade ensures a straight cut.



Carded Product	Length	Box/Case
26500	12"	5 / 50



Carbide and Diamond Grit Edge Saws



■ Carbide Grit Rod Saw



Made in U.S.A.

- Ideal for smooth finish curved cutting.

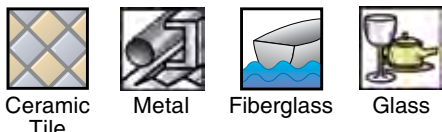

Carded Product	Fits	Length	Box/Case
26510	10" Hacksaws	10"	10 / 50
26512	12" Hacksaws	12"	10 / 50

■ CGD - Carbide Grit Hole Saw and Blade Display



Size: 19"W, 26"H



Made in U.S.A.



Carded Product	Description	Qty.
26500	12" Grit Hacksaw	5
26504	3" Grit Jig Saw	5
26510	10" Grit Rod Saw	10
26512	12" Grit Rod Saw	10
26600	3/8" Carbide Mandrel	4
26620	1-1/4" Hole Saw Kit	4
26622	1-3/8" Hole Saw Kit	4
26628	1-3/4" Hole Saw Kit	4
26632	2" Hole Saw Kit	2
26640	2-1/2" Hole Saw Kit	2
26720	1-1/4" Hole Saw	4
26722	1-3/8" Hole Saw	4
26728	1-3/4" Hole Saw	4
26732	2" Hole Saw	2
26740	2-1/2" Hole Saw	2

■ Diamond Grit Hole Saw

Wet and Dry Cutting

- Vacuum brazed diamond grit ensures long life.
- Uses low rpm with minimal pressure required.
- Lubricate with water for cool cutting.
- Slot in hole saw for easy plug removal.
- Overall length 2-3/16".



Available in sizes 3/16" - 1-3/8"
See details on page 23.

■ 1 3/8" Sintered Diamond Hole Saw

Segmented Rim
Dry or Wet Cutting

- Includes heavy-duty, one piece holesaw with 3/8" round shank.
- Cuts holes in granite counter tops and hard tiles.
- Ejector spring facilitates plug removal.



Carded Prod.	Dia.	Cutting Depth	Rim Width	Rim Depth	Box/Case
37826	1-3/8"	1-5/8"	2.6mm	8mm	1 / 5

■ Professional Carbide Grit Grout Saw

Removes & cleans old grout. Comes with 2 zinc-plated carbide grit blades. Use 1 or 2 blades depending on width of grout line. Contoured handle gives perfect angle for cutting grout.



Carded Product	Length	Box/Case
26030	8-1/2"	6 / 24
26031	Replacement Blade	6 / 24

■ D.I.Y. Carbide Grit Grout Saw

Comes with 2 zinc-plated carbide grit blades. Use 1 or 2 blades depending on width of grout line. Well shaped handle makes grout removal easy.



Carded Product	Length	Box/Case
26035	5-1/2"	6 / 24



Swift Bore® Twist Drills

Swift Bore® High-Speed Steel

- Roll Forged
- Two-Tone Finish



- Jobber length drills for steel, wood and plastic.
- General purpose 118° standard point.
- Two-tone finish, hardened and tempered.

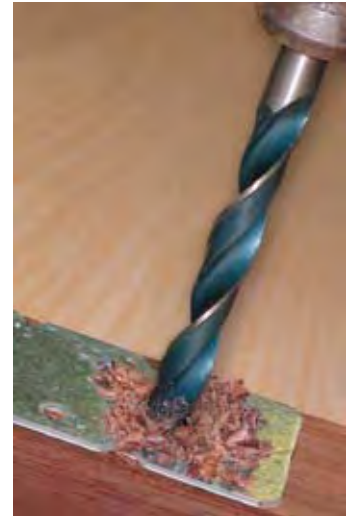

Bulk - Packed in envelopes

Prod.	Dia.	Overall Length	Envelope/Case	Qty.
03004	1/16"	1-7/8"	12 / 144	12
03005	5/64"	2"	12 / 144	12
03006	3/32"	2-1/4"	12 / 144	12
03007	7/64"	2-5/8"	12 / 144	12
03008	1/8"	2-3/4"	12 / 144	12
03009	9/64"	2-7/8"	12 / 144	12
03010	5/32"	3-1/3"	12 / 144	12
03011	11/64"	3-1/4"	12 / 144	12
03012	3/16"	3-1/2"	12 / 144	12
03013	13/64"	3-5/8"	12 / 144	12
03014	7/32"	3-3/4"	12 / 144	12
03015	15/64"	3-7/8"	12 / 144	12
03016	1/4"	4"	12 / 144	12
03017	17/64"	4-1/8"	12 / 144	12
03018	9/32"	4-1/4"	12 / 144	12
03019	19/64"	4-3/8"	6 / 72	6
03020	5/16"	4-1/2"	6 / 72	6
03021	21/64"	4-5/8"	6 / 72	6
03022	11/32"	4-3/4"	6 / 72	6
03023	23/64"	4-7/8"	6 / 72	6
03024	3/8"	5"	6 / 72	6
Shank Reduced to 3/8"				
03025	25/64"	5-1/8"	6 / 72	6
03026	13/32"	5-1/4"	6 / 72	6
03027	27/64"	5-3/8"	6 / 72	6
03028	7/16"	5-1/2"	6 / 72	6
03029	29/64"	5-5/8"	6 / 72	6
03030	15/32"	5-3/4"	6 / 72	6
03031	31/64"	5-7/8"	6 / 72	6
03032	1/2"	6"	6 / 72	6



Metal



Wood



Plastic



DBD1 - 29 Pc. HSS Drill Bit Merchandiser

Size:
12 1/4"W
14 1/2"H
15"D

- 29 Sizes: 1/16" through 1/2" by 64ths.
- Heavy-gauge steel merchandiser with lockable acrylic cover.
- Drill gauge on top of merchandiser and storage in back.



HSS Drill Bit Sets

- Sturdy metal cases with hinged index.
- Bits clearly visible.
- Sizes marked on case.



Shanks Reduced to 3/8"

Prod.	Desc.	Contents	Box/Case	Qty.
10390	13 Pc. Set	1/16" through 1/4" by 64ths	6 / 24	6
10392	12 Pc. Set	1/16, 3/32, 1/8, 5/32, 3/16, 7/32, 1/4, 9/32, 5/16, 3/8, 7/16, 1/2"	4 / 12	1
10393	21 Pc. Set	1/16" through 3/8" by 64ths	2 / 8	1
10394	29 Pc. Set	1/16" through 1/2" by 64ths	1 / 4	2

D DSD1 - HSS Drill Set Display



Size: 20"W, 14"H

Swift Bore® and Quick Change Drills



■ Silver and Deming Twist Drills High-Speed Steel

- Precision Ground
- Two-Tone Finish



- 118° Point requires minimum feed pressure.
- For steel, cast iron, plastic and wood.
- Three flat sides for secure chuck grip.
- Use in all drills & drill presses with 1/2" chuck.



Tubed Product	Diameter	Length	Box/Case	D Display
01036	9/16"	6"	1 / 12	1
01040	5/8"	6"	1 / 12	1
01044	11/16"	6"	1 / 12	1
01048	3/4"	6"	1 / 12	1
01052	13/16"	6"	1 / 12	1
01056	7/8"	6"	1 / 12	1
01060	15/16"	6"	1 / 12	1
01064	1"	6"	1 / 12	1

D SAD - Silver & Deming Display

Size:
12"W
12"H



■ Quick-Change Drills



Premium Swift Bore® - M2 High-Speed Steel



- 118° standard point, all bright finish.
- Very handy for Do-It-Yourselfers.
- Set contains five popular sizes in a sturdy plastic case.



Carded Product	Size	Box/Case	D Qty.
01808	1/8"	6 / 36	6
01810	5/32"	6 / 36	6
01812	3/16"	6 / 36	6
01814	7/32"	6 / 36	6
01816	1/4"	6 / 36	6
01817	5 Pc. Set	6 / 36	6



Set Contains:
1/8", 5/32",
3/16", 7/32",
1/4"

D QCD - Quick-Change Display

Size: 16"W, 14"H
Note: Also contains six 45638 - 1/4" Rapid-Reload® Holder (p. 46).



■ Countersinks

Premium Swift Bore® M2 High-Speed Steel



- 5 flutes, 82° point angle.
- 1/4" Round shank.



Carded Product	Size	Box/Case	D Qty.
09050	1/2"	5 / 25	5
09051	5/8"	5 / 25	5
09052	3/4"	5 / 25	5

D COD - Countersink Display

Size:
6"W
9"H





Premium Swift Bore® Twist Drills

Premium Swift Bore®

M2 High-Speed Steel

- Precision Ground
- Bright Finish



Bulk - Packed in envelopes

Prod.	Dia.	Overall Length	Envelope/Case	Qty.
01004	1/16"	1-7/8"	12 / 144	12
01005	5/64"	2"	12 / 144	12
01006	3/32"	2-1/4"	12 / 144	12
01007	7/64"	2-5/8"	12 / 144	12
01008	1/8"	2-3/4"	12 / 144	12
01009	9/64"	2-7/8"	12 / 144	12
01010	5/32"	3-1/3"	12 / 144	12
01011	11/64"	3-1/4"	12 / 144	12
01012	3/16"	3-1/2"	12 / 144	12
01013	13/64"	3-5/8"	12 / 144	12
01014	7/32"	3-3/4"	12 / 144	12
01015	15/64"	3-7/8"	12 / 144	12
01016	1/4"	4"	12 / 144	12
01017	17/64"	4-1/8"	12 / 144	12
01018	9/32"	4-1/4"	12 / 144	12
01019	19/64"	4-3/8"	6 / 72	6
01020	5/16"	4-1/2"	6 / 72	6
01021	21/64"	4-5/8"	6 / 72	6
01022	11/32"	4-3/4"	6 / 72	6
01023	23/64"	4-7/8"	6 / 72	6
01024	3/8"	5"	6 / 72	6
Shank Reduced to 3/8"				
01025	25/64"	5-1/8"	6 / 72	6
01026	13/32"	5-1/4"	6 / 72	6
01027	27/64"	5-3/8"	6 / 72	6
01028	7/16"	5-1/2"	6 / 72	6
01029	29/64"	5-5/8"	6 / 72	6
01030	15/32"	5-3/4"	6 / 72	6
01031	31/64"	5-7/8"	6 / 72	6
01032	1/2"	6"	6 / 72	6

Carded

Prod.	Dia.	Box/Case	Qty.
01104	1/16" - 2/card	12 / 72	6
01105	5/64" - 2/card	12 / 72	6
01106	3/32" - 2/card	12 / 72	6
01107	7/64" - 2/card	12 / 72	6
01108	1/8" - 2/card	12 / 72	6
01109	9/64"	12 / 72	6
01110	5/32"	12 / 72	6
01111	11/64"	12 / 72	6
01112	3/16"	12 / 72	6
01113	13/64"	12 / 72	6
01114	7/32"	12 / 72	6
01115	15/64"	12 / 72	6
01116	1/4"	12 / 72	6
01117	17/64"	12 / 72	6
01118	9/32"	12 / 72	6
01119	19/64"	6 / 36	3
01120	5/16"	6 / 36	3
01121	21/64"	6 / 36	3
01122	11/32"	6 / 36	3
01123	23/64"	6 / 36	3
01124	3/8"	6 / 36	3
Shank Reduced to 3/8"			
01125	25/64"	6 / 36	3
01126	13/32"	6 / 36	3
01127	27/64"	6 / 36	3
01128	7/16"	6 / 36	3
01129	29/64"	6 / 36	3
01130	15/32"	6 / 36	3
01131	31/64"	6 / 36	3
01132	1/2"	6 / 36	3



Metal

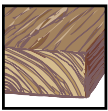

Wood



Plastic



DBD2 - 29 Pc. M2 HSS Drill Bit Merchandiser

Size:
12¼"W
14½"H
15"D



- 29 Sizes: 1/16" through 1/2" by 64ths.
- Heavy-gauge steel merchandiser with lockable acrylic cover.
- Drill gauge on top of merchandiser and storage in back.

DMC2 - 29 Pc. Carded M2 HSS Drill Bit Display

Size:
22"W,
24"H



Premium Swift Bore® Twist Drills

M2 HSS Drill Bit Sets

- Sturdy metal cases with hinged index.
- Bits clearly visible.
- Sizes marked on case.



Shanks Reduced to 3/8"

Prod.	Desc.	Contents	Box/Case	Qty.
10490	13 Pc. Set	1/16" through 1/4" by 64ths	6 / 24	6
10492	12 Pc. Set	1/16, 3/32, 1/8, 5/32, 3/16, 7/32, 1/4, 9/32, 5/16, 3/8, 7/16, 1/2"	4 / 12	1
10493	21 Pc. Set	1/16" through 3/8" by 64ths	2 / 8	1
10494	29 Pc. Set	1/16" through 1/2" by 64ths	1 / 4	2

D DSD2 - M2 HSS Drill Set Display

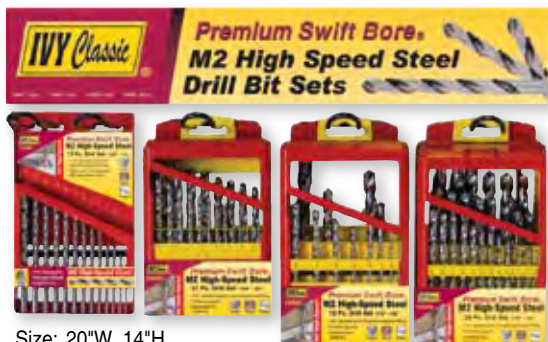

Size: 20"W, 14"H



Combo Drill Tap Bit

M2 High-Speed Steel



Metal



Drill
135° split point easily drills proper size hole for tapping.

Tap
Tapered design prevents thread damage.

Debur
Easily debur and countersink.

Fasten
For steel, copper, brass, aluminum and plastic.



Prod.	Size	Box/Case	Qty.
06002	*6-32NC	5 / 15	3
06003	*8-32NC	5 / 15	3
06004	*10-24NC	5 / 15	3
06005	*10-32NC	5 / 15	3
06006	*12-24NC	5 / 15	3
06007	*1/4"-20NC	5 / 15	3
06008	5/16"-18NC	5 / 15	3
06009	3/8"-16NC	5 / 15	3
06020	Drill/Tap Bit Set	5 / 10	3

* Set includes noted sizes plus 2" Phillips® and slotted power bits

D DTD - Drill/Tap Combo Display



Size: 22"W, 12"H



Hi-Molybdenum Steel Twist Drills

Hi-Molybdenum Steel Drill Bits

- Precision Ground
- Straw Finish

- Jobber length, 135° split point for fast penetration and accurate starting with no center punch.
- For stainless and hard steel, plastic and wood.
- Body is gold surface-treated for maximum lubricity.
- Heat-treated and nitro-carburize finished to be measurably harder than high-speed steel.



Made in U.S.A.



Stainless & Hard Steels



Wood



Plastic

Bulk - Packed in envelopes

Prod.	Dia.	Overall Length	Envelope/Case	Qty.
02004	1/16"	1-7/8"	12 / 144	12
02005	5/64"	2"	12 / 144	12
02006	3/32"	2-1/4"	12 / 144	12
02007	7/64"	2-5/8"	12 / 144	12
02008	1/8"	2-3/4"	12 / 144	12
02009	9/64"	2-7/8"	12 / 144	12
02010	5/32"	3-1/3"	12 / 144	12
02011	11/64"	3-1/4"	12 / 144	12
02012	3/16"	3-1/2"	12 / 144	12
02013	13/64"	3-5/8"	12 / 144	12
02014	7/32"	3-3/4"	12 / 144	12
02015	15/64"	3-7/8"	12 / 144	12
02016	1/4"	4"	12 / 144	12
02017	17/64"	4-1/8"	12 / 144	12
02018	9/32"	4-1/4"	12 / 144	12
02019	19/64"	4-3/8"	6 / 72	6
02020	5/16"	4-1/2"	6 / 72	6
02021	21/64"	4-5/8"	6 / 72	6
02022	11/32"	4-3/4"	6 / 72	6
02023	23/64"	4-7/8"	6 / 72	6
02024	3/8"	5"	6 / 72	6
Shank Reduced to 3/8"				
02025	25/64"	5-1/8"	6 / 72	6
02026	13/32"	5-1/4"	6 / 72	6
02027	27/64"	5-3/8"	6 / 72	6
02028	7/16"	5-1/2"	6 / 72	6
02029	29/64"	5-5/8"	6 / 72	6
02030	15/32"	5-3/4"	6 / 72	6
02031	31/64"	5-7/8"	6 / 72	6
02032	1/2"	6"	6 / 72	6

Carded

Prod.	Dia.	Box/Case	DMC3 Qty.	HMD Qty.
10504	1/16"	12 / 72	6	6
10505	5/64"	12 / 72	6	6
10506	3/32"	12 / 72	6	6
10507	7/64"	12 / 72	6	6
10508	1/8"	12 / 72	6	6
10509	9/64"	12 / 72	6	6
10510	5/32"	12 / 72	6	6
10511	11/64"	12 / 72	6	6
10512	3/16"	12 / 72	6	6
10513	13/64"	12 / 72	6	6
10514	7/32"	12 / 72	6	6
10515	15/64"	12 / 72	6	6
10516	1/4"	12 / 72	6	6
10517	17/64"	12 / 72	6	6
10518	9/32"	12 / 72	6	6
10519	19/64"	6 / 36	3	
10520	5/16"	6 / 36	3	3
10521	21/64"	6 / 36	3	
10522	11/32"	6 / 36	3	
10523	23/64"	6 / 36	3	
10524	3/8"	6 / 36	3	3
Shank Reduced to 3/8"				
10525	25/64"	6 / 36	3	
10526	13/32"	6 / 36	3	
10527	27/64"	6 / 36	3	
10528	7/16"	6 / 36	3	3
10529	29/64"	6 / 36	3	
10530	15/32"	6 / 36	3	
10531	31/64"	6 / 36	3	
10532	1/2"	6 / 36	3	3

DBD3 - 29 Pc. Hi-Moly Drill Bit Merchandiser

Size:
12 1/4"W
14 1/2"H
15"D

- 29 Sizes: 1/16" through 1/2" by 64ths.
- Heavy-gauge steel merchandiser with lockable acrylic cover.
- Drill gauge on top of merchandiser and storage in back.



DMC3 - 29 Pc. Carded Hi-Moly Drill Bit Display



Size:
22"W
24"H

Hi-Molybdenum Steel Twist Drills



Hi-Moly Drill Bit Sets

- Sturdy metal cases with hinged index.
- Bits clearly visible.
- Sizes marked on case.



Shanks Reduced to 3/8"

Prod.	Desc.	Contents	Box/Case	Qty.
10590	13 Pc. Set	1/16" through 1/4" by 64ths	6 / 24	6
10592	12 Pc. Set	1/16, 3/32, 1/8, 5/32, 3/16, 7/32, 1/4, 9/32, 5/16, 3/8, 7/16, 1/2"	4 / 12	1
10593	21 Pc. Set	1/16" through 3/8" by 64ths	2 / 8	1
10594	29 Pc. Set	1/16" through 1/2" by 64ths	1 / 4	1

D DSD3 - Hi-Moly Drill Set Display



Size: 20"W, 14"H

D HMD - 18 Pc. Carded Hi-Moly Drill Bit Display



Size: 19"W 20"H

Left Hand Drills

Use as or with a screw extractor.



- M7 High-Speed Steel, 8% Molybdenum
- 135° Split Point
- Full Bright Finish

Carded

Product	Size	Box/Case
01308	1/8"	3 / 12
01312	3/16"	3 / 12
01316	1/4"	3 / 12
01320	5/16"	3 / 12
01324	3/8"	3 / 12
5 Pc. Left Hand Drill Set		
01350	Includes 1/8", 3/16", 1/4", 5/16", 3/8"	1 / 6



Spiral Screw Extractors

Chrome Alloy-Steel

- Designed to remove broken screws, bolts and studs.
- Tapered left hand spiral flute grips screw firmly.
- Polished body and sandblasted flute prevent rust.
- Extractor size and matching drill size stamped on body.



Carded

Product	Size	Use Drill	Removes Screws	Box/Case	Display Qty.
01351	#1	5/64"	3/32 - 5/32"	6 / 24	6
01352	#2	7/64"	5/32 - 7/32"	6 / 24	6
01353	#3	5/32"	7/32 - 9/32"	6 / 24	6
01354	#4	1/4"	9/32 - 3/8", 1/8" Pipe	6 / 24	6
01355	#5	19/64"	3/8 - 5/8", 1/4" Pipe	6 / 24	6
01356	#6	13/32"	5/8 - 7/8", 3/8" Pipe	6 / 24	6
01357	#7	17/32"	7/8 - 1-1/8", 1/2" Pipe	6 / 24	6
01360	5 Pc. Set	Contains #1 - 5		6 / 24	6



D SSE - Spiral Screw Extractor Display



Size: 10"W, 17"H



Cobalt Steel Swift Bore® Twist Drills

Cobalt Steel Swift Bore®

Drill Bits

- Precision Ground
- Gold Finish

- Cobalt steel, gold finish.
- Precision ground, 135° split point.
- Retains hardness at high temperatures.



■ Cobalt Drill Bits - Bulk

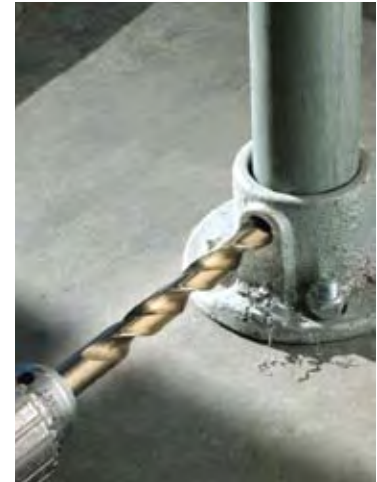

Bulk - Packed in envelopes



Stainless & Hard Steels

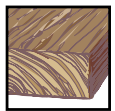

Wood



Plastic



Prod.	Dia.	Overall Length	Envelope/Case	D Qty.
04004	1/16"	1-7/8"	12 / 144	12
04005	5/64"	2"	12 / 144	12
04006	3/32"	2-1/4"	12 / 144	12
04007	7/64"	2-5/8"	12 / 144	12
04008	1/8"	2-3/4"	12 / 144	12
04009	9/64"	2-7/8"	12 / 144	12
04010	5/32"	3-1/3"	12 / 144	12
04011	11/64"	3-1/4"	12 / 144	12
04012	3/16"	3-1/2"	12 / 144	12
04013	13/64"	3-5/8"	12 / 144	12
04014	7/32"	3-3/4"	12 / 144	12
04015	15/64"	3-7/8"	12 / 144	12
04016	1/4"	4"	12 / 144	12
04017	17/64"	4-1/8"	12 / 144	12
04018	9/32"	4-1/4"	12 / 144	12
04019	19/64"	4-3/8"	6 / 72	6
04020	5/16"	4-1/2"	6 / 72	6
04021	21/64"	4-5/8"	6 / 72	6
04022	11/32"	4-3/4"	6 / 72	6
04023	23/64"	4-7/8"	6 / 72	6
04024	3/8"	5"	6 / 72	6
Shank Reduced to 3/8"				
04025	25/64"	5-1/8"	6 / 72	6
04026	13/32"	5-1/4"	6 / 72	6
04027	27/64"	5-3/8"	6 / 72	6
04028	7/16"	5-1/2"	6 / 72	6
04029	29/64"	5-5/8"	6 / 72	6
04030	15/32"	5-3/4"	6 / 72	6
04031	31/64"	5-7/8"	6 / 72	6
04032	1/2"	6"	6 / 72	6

D DBD4 - 29 Pc. Cobalt Drill Bit Merchandiser

- 29 Sizes: 1/16" through 1/2" by 64ths.
- Heavy-gauge steel merchandiser with lockable acrylic cover.
- Drill gauge on top of merchandiser and storage in back.



Size: 12¼"W, 14½"H, 15"D

Cobalt Steel Swift Bore® Twist Drills



■ Cobalt Drill Bit - Carded



Carded - 1 per card

Prod.	Dia.	Overall Length	Box/Case	DMC4 Qty.	CDD Qty.
04104	1/16"	1-7/8"	12 / 72	6	6
04105	5/64"	2"	12 / 72	6	6
04106	3/32"	2-1/4"	12 / 72	6	6
04107	7/64"	2-5/8"	12 / 72	6	6
04108	1/8"	2-3/4"	12 / 72	6	6
04109	9/64"	2-7/8"	12 / 72	6	6
04110	5/32"	3-1/3"	12 / 72	6	6
04111	11/64"	3-1/4"	12 / 72	6	6
04112	3/16"	3-1/2"	12 / 72	6	6
04113	13/64"	3-5/8"	12 / 72	6	6
04114	7/32"	3-3/4"	12 / 72	6	6
04115	15/64"	3-7/8"	12 / 72	6	6
04116	1/4"	4"	12 / 72	6	6
04117	17/64"	4-1/8"	12 / 72	6	6
04118	9/32"	4-1/4"	12 / 72	6	6
04119	19/64"	4-3/8"	6 / 36	3	
04120	5/16"	4-1/2"	6 / 36	3	3
04121	21/64"	4-5/8"	6 / 36	3	
04122	11/32"	4-3/4"	6 / 36	3	
04123	23/64"	4-7/8"	6 / 36	3	
04124	3/8"	5"	6 / 36	3	3
Shank Reduced to 3/8"					
04125	25/64"	5-1/8"	6 / 36	3	
04126	13/32"	5-1/4"	6 / 36	3	
04127	27/64"	5-3/8"	6 / 36	3	
04128	7/16"	5-1/2"	6 / 36	3	3
04129	29/64"	5-5/8"	6 / 36	3	
04130	15/32"	5-3/4"	6 / 36	3	
04131	31/64"	5-7/8"	6 / 36	3	
04132	1/2"	6"	6 / 36	3	3

D DMC4 - 29 Pc. Carded Cobalt Drill Bit Display



Size: 22"W, 25"H

D CDD - 18 Pc. Carded Cobalt Drill Bit Display



Size: 19"W, 20"H

■ Cobalt Drill Bit Sets

- Sturdy metal cases with hinged index.
- Bits clearly visible.
- Sizes marked on case.



Shanks Reduced to 3/8"

Prod.	Desc.	Contents	Box/Case	D Qty.
04188	5 Pc.	1/8, 3/16, 1/4, 5/16, 3/8	6 / 24	-
04190	13 Pc.	1/16" through 1/4" by 64ths	6 / 24	6
04192	12 Pc.	1/16, 3/32, 1/8, 5/32, 3/16, 7/32, 1/4, 9/32, 5/16, 3/8, 7/16, 1/2"	4 / 12	1
04193	21 Pc.	1/16" through 3/8" by 64ths	2 / 8	1
04194	29 Pc.	1/16" through 1/2" by 64ths	1 / 4	1

D DSD4 - Cobalt Drill Set Display



Size: 20"W, 14"H

IVY Classic® Four comprehensive lines of drill bits.

Swift Bore® High-Speed Steel Drills

General Purpose. Black oxide provides additional tempering.

Premium Swift Bore® M2 High-Speed Steel

General Purpose. Polished flutes increase chip ejection.

Hi-Molybdenum Steel Twist Drills

Heavy-Duty. Wear resistant against high temp and abrasion.

Cobalt Steel Swift Bore® Twist Drills

Heavy-Duty. Withstands heat generated by hard-to-machine metals.



Wire Gauge Drill Bits

Premium Swift Bore®

M7 High-Speed Steel 8% Molybdenum

- Precision Ground
- Bright Finish



- Jobber length, 135° split point for fast penetration and accurate starting with no center punch.
- For precise sizes that fall between standard fractional drill sizes.



Stainless & Hard Steels

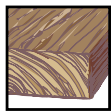

Wood



Plastic

DBD5 - Wire Gauge Drill Bit Merchandiser

- 60 Sizes: Numbers 1 - 60, contains one envelope of each size.
- Heavy-gauge steel merchandiser with lockable acrylic cover.
- Drill gauge on top and storage space in back.



Size: 12¼"W, 14½"H, 15"D

Wire Gauge Drill Bits - Straight Shank



Drill Size	Decimal Inches	Tap Size	Bulk		Carded	
			Product	Envelope/Case	Product	Box/Case
No. 1	0.2280	1/4"-40 NS	01401	12 / 48	01501	3 / 24
No. 2	0.2210		01402	12 / 48	01502	3 / 24
No. 3	0.2130	1/4"-28 NF	01403	12 / 48	01503	3 / 24
No. 4	0.2090	1/4"-24 NS	01404	12 / 48	01504	3 / 24
No. 5	0.2055		01405	12 / 48	01505	3 / 24
No. 6	0.2040		01406	12 / 48	01506	3 / 24
No. 7	0.2010	1/4"-20NC, 14-24NS	01407	12 / 48	01507	3 / 24
No. 8	0.1990		01408	12 / 48	01508	3 / 24
No. 9	0.1960		01409	12 / 48	01509	3 / 24
No. 10	0.1935	14-20 NS	01410	12 / 48	01510	3 / 24
No. 11	0.1910		01411	12 / 48	01511	3 / 24
No. 12	0.1890		01412	12 / 48	01512	3 / 24
No. 13	0.1850	12-32 NEF	01413	12 / 48	01513	3 / 24
No. 14	0.1820	12-28 NF	01414	12 / 48	01514	3 / 24
No. 15	0.1800		01415	12 / 48	01515	3 / 24
No. 16	0.1770	12-24 NC	01416	12 / 48	01516	3 / 24
No. 17	0.1730		01417	12 / 48	01517	3 / 24
No. 18	0.1695		01418	12 / 48	01518	3 / 24
No. 19	0.1660		01419	12 / 48	01519	3 / 24
No. 20	0.1610		01420	12 / 48	01520	3 / 24
No. 21	0.1590	10-32 NF	01421	12 / 48	01521	3 / 24
No. 22	0.1570	3/16"-32 NS	01422	12 / 48	01522	3 / 24
No. 23	0.1540		01423	12 / 48	01523	3 / 24
No. 24	0.1520		01424	12 / 48	01524	3 / 24
No. 25	0.1495	10-24 NC	01425	12 / 48	01525	3 / 24
No. 26	0.1470	3/16"-24 NS	01426	12 / 48	01526	3 / 24
No. 27	0.1440		01427	12 / 48	01527	3 / 24
No. 28	0.1405	8-40 NS	01428	12 / 48	01528	3 / 24
No. 29	0.1360	8-32 NC, 8-36 NF	01429	12 / 48	01529	3 / 24
No. 30	0.1285		01430	12 / 48	01530	3 / 24
No. 31	0.1200	6-48 NS	01431	12 / 48	01531	3 / 24
No. 32	0.1160		01432	12 / 48	01532	3 / 24
No. 33	0.1130	6-40 NF	01433	12 / 48	01533	3 / 24
No. 34	0.1110	6-36 NS	01434	12 / 48	01534	3 / 24
No. 35	0.1100	6-32 NC	01435	12 / 48	01535	3 / 24
No. 36	0.1065		01436	12 / 48	01536	3 / 24
No. 37	0.1040	5-44 NF	01437	12 / 48	01537	3 / 24
No. 38	0.1015	1/8"-40 NS, 5-40 NC	01438	12 / 48	01538	3 / 24
No. 39	0.0995		01439	12 / 48	01539	3 / 24
No. 40	0.0980		01440	12 / 48	01540	3 / 24
No. 41	0.0960		01441	12 / 48	01541	3 / 24
No. 42	0.0935	4-48 NF	01442	12 / 48	01542	3 / 24
No. 43	0.0890	4-40 NC	01443	12 / 48	01543	3 / 24
No. 44	0.0860	4-36 NS	01444	12 / 48	01544	3 / 24
No. 45	0.0820	3-56 NF	01445	12 / 48	01545	3 / 24
No. 46	0.0810		01446	12 / 48	01546	3 / 24
No. 47	0.0785	3-48 NC	01447	12 / 48	01547	3 / 24
No. 48	0.0760		01448	12 / 48	01548	3 / 24
No. 49	0.0730		01449	12 / 48	01549	3 / 24
No. 50	0.0700	2-56 NC, 2-64 NF	01450	12 / 48	01550	3 / 24
No. 51	0.0670		01451	12 / 48	01551	3 / 24
No. 52	0.0635		01452	12 / 48	01552	3 / 24
No. 53	0.0595	1-64 NC, 1-72 NF	01453	12 / 48	01553	3 / 24
No. 54	0.0550		01454	12 / 48	01554	3 / 24
No. 55	0.0520		01455	12 / 48	01555	3 / 24
No. 56	0.0465		01456	12 / 48	01556	3 / 24
No. 57	0.0430		01457	12 / 48	01557	3 / 24
No. 58	0.0420		01458	12 / 48	01558	3 / 24
No. 59	0.0410		01459	12 / 48	01559	3 / 24
No. 60	0.0400		01460	12 / 48	01560	3 / 24

• NC = National Coarse (USS)
• NS = National Special

NF = National Fine (SAE)
NEF = National Extra Fine

Letter/Number Twist Drills



Letter Drills

Drills holes for the most popular tap sizes.

- M7 High-Speed Steel, 8% Molybdenum
- 135° Split Point
- Full Bright Finish



Stainless & Hard Steels



Bulk

Product	Size	For Tap Size	Envelope/Case
01606	F	5/16"-18 NC	12 / 48
01609	I	5/16"-24 NF	12 / 48
01617	Q	3/8"-24 NF	12 / 48
01621	U	7/16"-14 NC	12 / 48

Carded

Product	Size	For Tap Size	Box/Case
01646	F	5/16"-18 NC	3 / 24
01649	I	5/16"-24 NF	3 / 24
01657	Q	3/8"-24 NF	3 / 24
01661	U	7/16"-14 NC	3 / 24

5 Pc. Number/Letter Drill Set

Product	Sizes	Box/Case
01668	#7, F, I, Q, U	1 / 6



60 Pc. Wire Gauge Drill Bit Set

Premium Swift Bore® M7 High-Speed Steel 8% Molybdenum



Stainless & Hard Steels

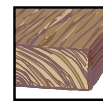

Wood



Plastic

- M7 High-Speed Steel, 8% Molybdenum
- Numbers 1 - 60, in a metal case with three stacking bit holders
- Full Bright Finish
- 135° Split Point
- Sizes marked.



Product	Description	Box / Case
01581	60 Pc. Wire Gauge (Number) Drill Set	1 / 6

NLD - 18 Pc. Number/Letter Drill Display

Drills exact hole size for the most popular taps.



Size:
19"W
20"H

Product	Size	Display Qty.	Product	Size	Display Qty.
01503	No. 3	3	01530	No. 30	3
01507	No. 7	3	01536	No. 36	3
01509	No. 9	3	01539	No. 39	3
01516	No. 16	3	01543	No. 43	3
01519	No. 19	3	01544	No. 44	3
01520	No. 20	3	01646	F	3
01521	No. 21	3	01649	I	3
01525	No. 25	3	01657	Q	3
01529	No. 29	3	01661	U	3

Double-End Drill Bits

Ideal for drilling sheet metal and aluminum.

- M2 High Speed Steel
- 135° Split Point
- Bright Finish



Metal



Bulk - Packed in envelopes

Product	Diameter	Length	Box/Case
Fractional			
01707	7/64"	2"	12 / 72
01708	1/8"	2"	12 / 72
01709	9/64"	2"	12 / 72
01710	5/32"	2"	12 / 72
01711	3/16"	2"	12 / 72
01712	7/32"	2"	12 / 72
01713	1/4"	2"	12 / 72
Wire Gauge			
01730	No. 11	2"	12 / 72
01731	No. 20	2"	12 / 72
01732	No. 30	2"	12 / 72

JAR Double-End Drill Bit Jars

Product	Size	Contents	Box/Case
45980	1/8"	144 Pcs. of 01708	1 / 4
45988	No. 30	144 Pcs. of 01732	1 / 4



IVY Classic® Long Steel Twist Drills

Premium Swift Bore®

M2 High-Speed Steel

- Precision Ground
- Bright Finish

■ 12" Aircraft Drill Bits



Metal



Wood



Plastic

- For hard-to-reach and deep drilling applications.
- 135° split point for fast penetration and accurate starting with no center punch.

Carded Product	Dia.	Shank	Length	Box/Case	Qty.
46508	1/8"	1/8"	12"	5 / 20	5
46512	3/16"	3/16"	12"	5 / 20	5
46516	1/4"	1/4"	12"	5 / 20	5
46520	5/16"	5/16"	12"	5 / 20	5
46524	3/8"	3/8"	12"	5 / 20	5
46528	7/16"	3/8"	12"	5 / 20	5
46532	1/2"	3/8"	12"	5 / 20	5



D ADD - Aircraft Drill Bit Display



Size: 14"W, 19"H

Swift Bore® High-Speed Steel

- Heat-treated
- Tempered

■ 18" Bell Hanger Installer Drill Bits



Wood



Plaster

- For installing telephone, cable TV, computer and security wires.
- Hole in flute for pulling wires through walls, ceilings and floors.
- 82° point for fast boring in wood, plaster and metal lath.
- Heat-treated and tempered.

Pouched Product	Dia.	Shank	Length	Box/Case	Qty.
46416	1/4"	1/4"	18"	5 / 20	5
46420	5/16"	5/16"	18"	5 / 20	5
46424	3/8"	3/8"	18"	5 / 20	5
46432	1/2"	3/8"	18"	5 / 20	5



D BID - Installer Bit Display

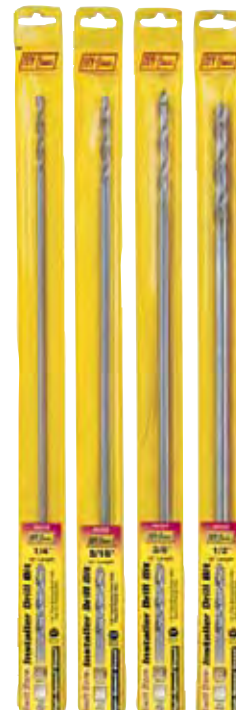

Size: 7"W, 25"H

Premium Swift Bore®

High-Speed Molybdenum Steel

- Precision Ground
- Bright Finish



Metal



Wood



Plastic

■ Step Drills

- Produce perfectly round burr-free holes in materials up to 3/8" thick.
- Up to 13 conventional drill sizes on one bit.
- Lobular shanks won't slip in the drill chuck.
- Sizes are laser marked on the bit for easy hole size identification.
- Cone shape of the bit adds strength so there is no flexing of the bit while drilling.
- Economical and practical for electricians, auto mechanics, sheetmetal workers, and general contractors.



■ Fractional Sure-Start Step Drills

- Sure-Start point, fast penetration and accurate starting with no punch needed.



Carded Product	# of Holes	Range	Step Increments	Hole Sizes	Shank Size	Max. Material Thickness	Box/Case
09001	13	1/8 - 1/2"	1/32"	1/8, 5/32, 3/16, 7/32, 1/4, 9/32, 5/16, 11/32, 3/8, 13/32, 7/16, 15/32, 1/2"	1/4"	1/8"	1 / 5
09002	6	3/16 - 1/2"	1/16"	3/16, 1/4, 5/16, 3/8, 7/16, 1/2"	1/4"	3/8"	1 / 5
09003	9	1/4 - 3/4"	1/16"	1/4, 5/16, 3/8, 7/16, 1/2, 9/16, 5/8, 11/16, 3/4"	3/8"	1/8"	1 / 5
09004	12	3/16 - 7/8"	1/16"	3/16, 1/4, 5/16, 3/8, 7/16, 1/2, 9/16, 5/8, 11/16, 3/4, 13/16, 7/8"	3/8"	1/8"	1 / 5

■ Electricians' Step Drills

09008	5	1/4 - 1-1/8"	-	1/4, 3/8, 1/2, 7/8, 1-1/8"	3/8"	1/8"	1 / 5
09014	5	7/8 - 1-3/8"	-	7/8, 1-1/8, 1-7/32, 1-1/4, 1-3/8"	1/2"	1/8"	1 / 5

■ Fractional Hole Enlarging Step Drills

- For hole enlarging, requires a pilot hole.



Carded Product	# of Holes	Range	Step Increments	Hole Sizes	Shank Size	Max. Material Thickness	Box/Case
09020*	8	9/16 - 1"	1/16"	9/16, 5/8, 11/16, 3/4, 13/16, 7/8, 15/16, 1"	1/2"	1/8"	1 / 5

*Companion to 09001 for diameters of 1/8" - 1". These two bits drill 99% of common diameters.

09021	11	3/4 - 1-3/8"	1/16"	3/4, 13/16, 7/8, 15/16, 1, 1-1/16, 1-1/8, 1-3/16, 1-1/4, 1-5/16, 1-3/8"	1/2"	1/8"	1 / 5
-------	----	--------------	-------	---	------	------	-------

Ideal for 1" conduit and tubing.

■ Single Hole Smooth-Step Drill

- Ideal for drilling knockouts in electrical boxes for 1/2" conduit. Makes perfect drawbolt holes and miniature pilot light holes.
- Maximum material thickness - 1/8".



Carded

Product	Hole Size	Shank Size	Box/Case
09011	7/8"	3/8"	1 / 5

D SDD - Step Drill Display

Product	Qty.
09001	1
09002	1
09003	1
09004	1
09008	1
09011	1
09014	1
09020	1
09021	1

Size:
12"W,
26"H





Power Auger Bits

Swift Bore®

• Heat-treated and Tempered

Designed to cut holes in plywood and hard and soft woods.

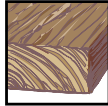

Wood

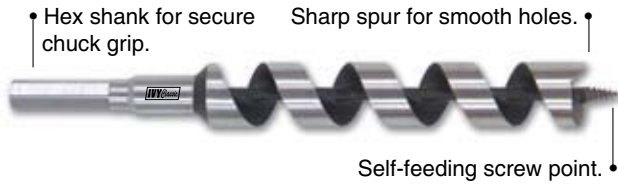

■ 7-1/2" Power Auger Bits

Tubed Product	Diameter	Hex Shank	Box/Case	Qty
46204	1/4"	1/4"	1 / 12	1
46205	5/16"	5/16"	1 / 12	1
46206	3/8"	3/8"	1 / 12	1
46207	7/16"	3/8"	1 / 12	1
46208	1/2"	3/8"	1 / 12	1
46209	9/16"	3/8"	1 / 12	1
46210	5/8"	3/8"	1 / 12	1
46211	11/16"	3/8"	1 / 12	1
46212	3/4"	3/8"	1 / 12	1
46213	13/16"	3/8"	1 / 12	1
46214	7/8"	3/8"	1 / 12	1
46215	15/16"	3/8"	1 / 12	1
46216	1"	3/8"	1 / 12	1
46218	1-1/8"	7/16"	1 / 12	1
46220	1-1/4"	7/16"	1 / 12	1



D PAS - 7-1/2" Power Auger Display



Size: 12"W, 22"H

■ 18" Power Auger Bits

Tubed Product	Dia.	Hex Shank	Length	Box/Case	Qty.
46306	3/8"	3/8"	18"	1 / 12	1
46308	1/2"	3/8"	18"	1 / 12	1
46310	5/8"	7/16"	18"	1 / 12	1
46311	11/16"	7/16"	18"	1 / 12	1
46312	3/4"	7/16"	18"	1 / 12	1
46313	13/16"	7/16"	18"	1 / 12	1
46314	7/8"	7/16"	18"	1 / 12	1
46315	15/16"	7/16"	18"	1 / 12	1
46316	1"	7/16"	18"	1 / 12	1
46317	1-1/16"	7/16"	18"	1 / 12	1
46318	1-1/8"	7/16"	18"	1 / 12	1
46320	1-1/4"	7/16"	18"	1 / 12	1



D PAL - 18" Power Auger Display



Size: 17"W, 25"H

Ship Auger and Brad Point Bits



Swift Bore®



Nail Embedded Wood

Designed to cut holes in nail-embedded wood. Rockwell Hardness 45 - 55.

■ 18" Nail Cutting Ship Augers

Product	Dia.	Power Shank	Length	Box/Case	Qty.
46326	3/8"	5/16"	18"	1 / 12	1
46328	1/2"	5/16"	18"	1 / 12	1
46330	5/8"	7/16"	18"	1 / 12	1
46332	3/4"	7/16"	18"	1 / 12	1
46334	7/8"	7/16"	18"	1 / 12	1
46336	1"	7/16"	18"	1 / 12	1
46338	1-1/8"	7/16"	18"	1 / 12	1
46339	1-1/4"	7/16"	18"	1 / 12	1

D SAM - 18" Nail Cutting Ship Auger Display



Size: 17"W, 25"H



Premium Swift Bore®



■ Brad Point Drill Bits

High-Speed Chrome Vanadium Steel

- Precision Ground
- Bright Finish
- Heat-Treated and Tempered

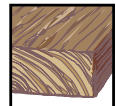

Wood

Brad point centers the bit.

Two spurs cut a true hole outline.



For accurate, precision holes across the grain for doweling and cabinetry.

Tubed Product	Diameter	Length	Box/Case
01908	1/8"	2-3/4"	6 / 24
01912	3/16"	3-1/2"	6 / 24
01916	1/4"	4"	6 / 24
01920	5/16"	4-1/2"	6 / 24
01924	3/8"	5"	6 / 24
01928*	7/16"	5-1/2"	6 / 24
01932*	1/2"	6"	6 / 24

* 3/8 Reduced Shank



5 Pc. Brad Point Set

Product	Description	Box/Case
01955	5 Pc. Brad Point Set Contains: 1/8", 3/16", 1/4", 5/16", 3/8"	2 / 12





Spade Boring Bits and Extensions

Swift Bore®



Wood

6" Wood Spade Bits

- 1/4" Quick-Change hex shank.
- Precision ground and polished.
- Double-fluted chip remover with sharp spurs.



- Electronically heat-treated to Rockwell Hardness 47-52.

Drop-forged, high carbon #65 steel.

- Double-fluted chip removers ensure faster cutting with a smooth finish.

Carded Product	Dia.	Length	Box/Case	Qty.
10704	1/4"	6"	6 / 36	6
10705	5/16"	6"	6 / 36	6
10706	3/8"	6"	6 / 36	6
10707	7/16"	6"	6 / 36	6
10708	1/2"	6"	6 / 36	6
10709	9/16"	6"	6 / 36	6
10710	5/8"	6"	6 / 36	6
10711	11/16"	6"	6 / 36	6
10712	3/4"	6"	6 / 36	6
10713	13/16"	6"	6 / 36	6
10714	7/8"	6"	6 / 36	6
10715	15/16"	6"	6 / 36	6
10716	1"	6"	6 / 36	6
10718	1-1/8"	6"	6 / 36	6
10720	1-1/4"	6"	6 / 36	6
10722	1-3/8"	6"	6 / 36	6
10724	1-1/2"	6"	6 / 36	6



D SBD - Swift Bore® Wood Spade Bit Display



Size: 20"W, 18"H

6 Pc. Wood Spade Bit Set

- 1/4" Quick-Change hex shank.
- Drop-forged, high-carbon #65 steel.
- Double-fluted chip removers with sharp spurs.



Wood Spade Set Contains: 3/8", 1/2", 5/8", 3/4", 7/8", 1"

Product	Description	Box/Case
10726	6 Pc. Set	4 / 24

Wood Spade Bit Extensions



- Extends any 1/4" shank bit an additional 6" or 12".
- 2 set screws & hex key included.



Carded Product	Length	Box/Case
10700	6"	6 / 36
10702	12"	6 / 36

Rapid Reload® Power Bit Extensions

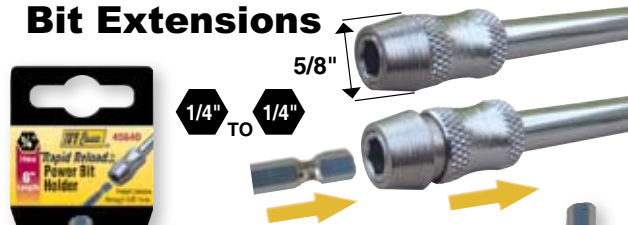

- Tapered head allows extension to pass through a 5/8" hole.
- Power bit held in place by ball and spring retention.
- Nickel plated for long life.



Carded Product	Size	Box/Case	Qty.
45638	2-3/8"	6 / 24	6
45640	6"	6 / 24	6
45642	12"	6 / 24	6

Long Spade Bits and Self-Feed Bits



Swift Bore®

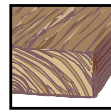

Wood

■ 16" Wood Spade Bits

- Drop-forged high-carbon #65 steel.
- Heat-treated to Rockwell Hardness 47 - 52.
- Double-fluted chip removers with sharp spurs.

Pouched

Product	Dia.	Length	Box/Case	Qty.
10740	3/8"	16"	4 / 16	4
10742	1/2"	16"	4 / 16	4
10744	5/8"	16"	4 / 16	4
10746	3/4"	16"	4 / 16	4
10748	7/8"	16"	4 / 16	4
10750	1"	16"	4 / 16	4

LSB - Long Spade Bit Display



Size:
12"W
25"H

Swift Bore® High-Speed Steel

■ Heavy-Duty Self-Feed Bits

- Perfect for plumbers and electricians who bore holes in wood to run pipe and conduit.
- Rockwell Hardness 52 - 60.

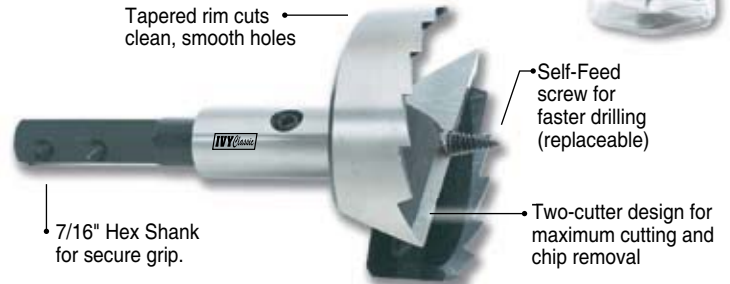

■ Tubed - Includes one hex key and replacement screw.

Product	Dia.	For Pipe Entr. Size	For Tubing Entr. Size	Box/Case	Qty.
10761	1-1/8"	3/4"	1"	1 / 5	1
10763	1-3/8"	1"	1-1/4"	1 / 5	1
10764	1-1/2"	---	1-3/8"	1 / 5	1
10765	1-3/4"	1-1/4"	1-1/2"	1 / 5	1
10766	2-1/8"	1-1/2"	2"	1 / 5	1
10768	2-9/16"	2"	2-1/2"	1 / 5	1
10769	3-5/8"	3"	3-1/2"	1 / 5	1

Replacement Hex Key and Screw

10774	4mm - Fits 1-1/8" & 1-3/8"	1 / 5	-
10775	5mm - Fits 1-1/2", 1-3/4" & 2-1/8"	1 / 5	-
10776	6mm - Fits 2-9/16" & 3-5/8"	1 / 5	-

■ Self-Feed Bit Extensions

- 7/16" hex shank for secure grip.
- Extends any Self-Feed bit.
- 2 set screws and hex key included.



Tubed Product	Length	Box/Case	Qty.
10777	5-1/2"	1 / 5	1
10778	12"	1 / 5	1

SFD - Self-Feed Bit Display



Size: 14"W, 22"H



Forstner Bits

Swift Bore® High-Speed Steel

Forstner Bits

- Designed to cut holes in wood and plywood.
- Rockwell Hardness 52-56.

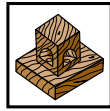
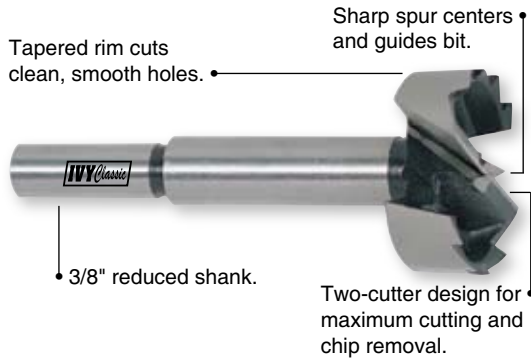

Smooth pocket holes

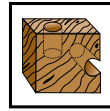

Angled Holes

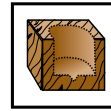

Flat bottom holes

5 Pc. Forstner Bit Set

Forstner bit set contains: 3/4", 7/8", 1", 1-1/4", 1-3/8" bits in a wooden case.

Product	Description	Box/Case
46180	5 Pc. Forstner Bit Set	1 / 4



7 Pc. Forstner Bit Set

Forstner bit set contains: 1/4", 3/8", 1/2", 5/8", 3/4", 7/8", 1" bits in a wooden case.



Product	Description	Box/Case
46182	7 Pc. Forstner Bit Set	1 / 4

16 Pc. Forstner Bit Set

Forstner bit set contains: 1/4", 3/8", 1/2", 5/8", 7/8", 3/4", 1", 1-1/8", 1-3/8", 1-1/4", 1-1/2", 1-5/8", 1-3/4", 1-7/8", 2", 2-1/8" bits in a wooden case.

Product	Description	Box/Case
46184	16 Pc. Forstner Bit Set	1 / 4



Carded Product	Diameter	Length	Box/Case	Qty.
46104	1/4"	3-1/8"	1 / 5	1
46106	3/8"	3-1/2"	1 / 5	1
46108	1/2"	3-1/2"	1 / 5	1
46110	5/8"	3-1/2"	1 / 5	1
46112	3/4"	3-1/2"	1 / 5	1
46114	7/8"	3-1/2"	1 / 5	1
46116	1"	3-1/2"	1 / 5	1
46118	1-1/8"	3-1/2"	1 / 5	1
46120	1-1/4"	3-1/2"	1 / 5	1
46122	1-3/8" (35mm)	3-1/2"	1 / 5	1
46124	1-1/2"	3-1/2"	1 / 5	1
46126	1-5/8"	3-1/2"	1 / 5	1
46128	1-3/4"	3-1/2"	1 / 5	1
46130	1-7/8"	3-1/2"	1 / 5	1
46132	2"	3-1/2"	1 / 5	1
46134	2-1/8"	3-1/2"	1 / 5	1

- Sizes 1-1/8" and over have multi-spur cutting edges.

FSB - Forstner Bit Display

Size: 22 1/2"W, 26"H



1-3/8" (35mm) Carbide Forstner Bit

- C2 carbide for longest life.
- 2 straight cutting teeth & 2 scoring teeth.



Carded Product	Diameter	Length	Box/Case	Qty.
10908	1-3/8" (35mm)	3-1/2"	1 / 15	1

4" Forstner Bit Extension

- Extends any Forstner shank bit an additional 4".
- 2 set screws and hex key included.



Tubed Product	Length	Box/Case	Qty.
46152	4"	1 / 5	1

Premium Carbide Masonry Drills

Swift Cut®

Premium Carbide Masonry Bits - Carded

Round shank designed for rotary and percussion hammer drilling.

- Drills through block, brick, stone, concrete & marble.
- Induction-hardened body for straightness & strength.
- Precision-ground tips are carbide grade BC20.
- Engineered with wide flutes for fast dust removal.



Marble



Brick



Concrete & Block



Stone

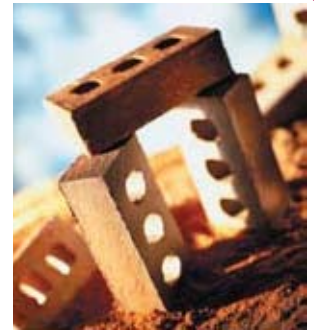

Black Oxide Finish

Sandblasted Finish

Carded

Prod.	Dia.	Shank	Length	Box/Case
10208	1/8"	1/8"	3"	12 / 72
4" Masonry Drill Bits - 2 1/4" Flute Length				
10212	3/16"	3/16"	4"	12 / 72
10216	1/4"	1/4"	4"	12 / 72
10220	5/16"	1/4"	4"	12 / 72
10224	3/8"	5/16"	4"	6 / 36
10231	1/2"	3/8"	4"	6 / 36
6" Masonry Drill Bits - 3 3/8" Flute Length				
10217	1/4"	1/4"	6"	12 / 72
10221	5/16"	1/4"	6"	12 / 72
10225	3/8"	5/16"	6"	6 / 36
10232	1/2"	3/8"	6"	6 / 36
10240	5/8"	3/8"	6"	3 / 18
10248	3/4"	1/2"	6"	3 / 18
10249	7/8"	1/2"	6"	3 / 12
10250	1"	1/2"	6"	3 / 12
12" Masonry Drill Bits - 6 3/4" Flute Length				
10316	1/4"	1/4"	12"	3 / 12
10320	5/16"	5/16"	12"	3 / 12
10324	3/8"	3/8"	12"	3 / 12
10332	1/2"	3/8"	12"	3 / 12
10340	5/8"	3/8"	12"	3 / 12
10348	3/4"	1/2"	12"	3 / 12
10349	7/8"	1/2"	12"	3 / 6
10350	1"	1/2"	12"	3 / 6
18" Masonry Drill Bits - 12" Flute Length				
10351	1/4"	1/4"	18"	2 / 6
10352	5/16"	5/16"	18"	2 / 6
10353	3/8"	3/8"	18"	2 / 6
10354	1/2"	3/8"	18"	2 / 6
10355	5/8"	3/8"	18"	2 / 6
10356	3/4"	1/2"	18"	2 / 6
10357	7/8"	1/2"	18"	2 / 6
10358	1"	1/2"	18"	2 / 6

D
PMD
Qty.

D
PMD2
Qty.

2
2
2
2
2
2
2



Premium Carbide Masonry Drills - Bulk

Prod.	Dia.	Length	Envelope Qty.
10300	1/8"	3"	25
10301	3/16"	4"	25
10302	1/4"	4"	25
10303	1/4"	6"	25
10304	5/16"	4"	25
10305	5/16"	6"	25
10306	3/8"	4"	25
10307	3/8"	6"	25
10308	1/2"	4"	25
10309	1/2"	6"	25

Premium Carbide Masonry 5 Pc. Set

- Plastic re-usable drill index.
- Bits clearly visible.

Contains the following drills:
3/16" x 4", 1/4" x 4", 5/16" x 4",
3/8" x 4", 1/2" x 4"

Product	Description	Box/Case
10256	Masonry 5 Pc. Set	6 / 24



D PMD1 - Masonry Drill Display



Size:
25"W,
24 1/2"H

D PMD2 - 18" Masonry Drill Display



Size:
12"W,
25"H



Hole in 18" masonry bits for pulling wires through walls, ceilings and floors.



Premium Carbide Masonry Drills

Industrial Concrete Screw Drill Bits

- Designed for drilling exact holes for Tapcon® concrete anchor screws.
- Special shank fits concrete screw installation tools.
- Body is induction-hardened for straightness and strength.
- Precision carbide tip designed for rotary and percussion drilling.



Bulk				
Product	Dia.	Length	Box/Case	Qty
10268	5/32"	4-1/2"	12 / 72	
10270	5/32"	5-1/2"	12 / 72	
10274	3/16"	4-1/2"	12 / 72	
10276	3/16"	5-1/2"	12 / 72	
Carded				
10279	5/32"	4-1/2"	6 / 24	6
10280	5/32"	5-1/2"	6 / 24	6
10282	3/16"	4-1/2"	6 / 24	6
10283	3/16"	5-1/2"	6 / 24	6

SDS Plus® Industrial Concrete Screw Drill Bits With Hex Shank

- Hex shank fits directly into drive sleeve for concrete screw installation tools.
- Tungsten carbide head.



Carded				
Product	Dia.	Length	Box/Case	Qty.
47185	5/32"	7"	3 / 12	3
47187	3/16"	7"	3 / 12	3

CSD - Industrial Concrete Screw Drill Bit Display



Size:
10"W
14"H



Industrial Concrete Screw Installation Kits

Kit 10298 Contains:

- 45600 - 1/4" Magnetic Driver
- 45602 - 5/16" Magnetic Driver
- 45604 - Phillips Bit Adapter
- 45606 - Masonry Drill Holder
- 45608 - Sleeve 5.7" long
- 45002 - No. 2 Phillips Bit
- 45004 - No. 3 Phillips Bit
- 45616 - 1/8" Hex Key



10298

Kit 10299 Contains:

- 45600 - 1/4" Magnetic Driver
- 45602 - 5/16" Magnetic Driver
- 45604 - Phillips Bit Adapter
- 45608 - Sleeve 5.7" long
- 45002 - No. 2 Phillips Bit
- 45004 - No. 3 Phillips Bit
- 45616 - 1/8" Hex Key
- 47185 - 5/32" x 7" SDS® Concrete Screw Drill
- 47187 - 3/16" x 7" SDS® Concrete Screw Drill



10299



Product	Description	Box/Case
10298	Industrial Concrete Screw Installation Kit	1 / 12
10299	SDS Plus® Industrial Concrete Screw Installation Kit	1 / 12



SDS Plus® Chisels

- Chrome molybdenum alloy steel.
- Hex body



SDC - SDS Plus® Chisel Display

Display contains 3 of each chisel listed below.
Size: 5"W, 16"H

Carded			
Product	Description	Size	Box/Case
47300	Point Chisel	10"	5 / 25
47302	Flat Chisel	3/4" x 10"	5 / 25
47304	Wide Chisel	1-1/2" x 10"	5 / 25



SDS Plus® Carbide Hammer Drill Bits



■ SDS Plus® Masonry Drills

- Fits all SDS Plus® hammer drills
- Meets all ANSI specifications



Marble



Brick



Concrete & Block



Stone

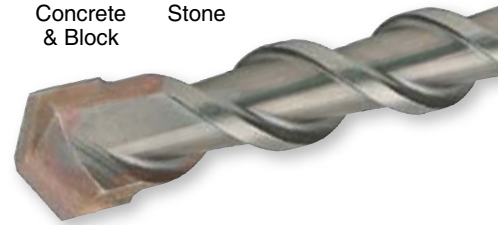
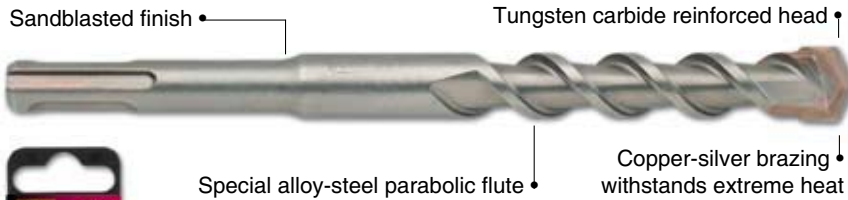

Hang Tag

Product	Drill Dia.	Overall Length	Usable Length	Box/Case	D Qty.
47002	5/32"	6"	4"	1 / 12	1
47004	3/16"	4"	2"	1 / 12	1
47006	3/16"	6"	4"	1 / 12	1
47008	3/16"	8"	6"	1 / 12	1
47012	3/16"	12"	10"	1 / 12	1
47020	7/32"	6"	4"	1 / 12	1
47032	1/4"	4"	2"	1 / 12	1
47034	1/4"	6"	4"	1 / 12	1
47036	1/4"	8"	6"	1 / 12	1
47038	1/4"	12"	10"	1 / 12	1
47052	5/16"	6"	4"	1 / 12	1
47054	5/16"	8"	6"	1 / 12	1
47056	5/16"	12"	10"	1 / 12	1
47060	3/8"	6"	4"	1 / 12	1
47062	3/8"	8"	6"	1 / 12	1
47064	3/8"	12"	10"	1 / 12	1
47068	3/8"	18"	16"	1 / 12	1
47072	7/16"	6"	4"	1 / 12	1
47074	7/16"	12"	10"	1 / 12	1
47078	1/2"	6"	4"	1 / 12	1
47080	1/2"	8"	6"	1 / 12	1
47082	1/2"	12"	10"	1 / 12	1
47086	1/2"	18"	16"	1 / 12	1
47090	9/16"	6"	4"	1 / 12	1
47096	9/16"	17 3/4"	15 3/4"	1 / 12	1
47100	5/8"	8"	6"	1 / 12	1
47102	5/8"	12"	10"	1 / 12	1
47106	5/8"	17 3/4"	15 3/4"	1 / 12	1
47116	3/4"	8"	6"	1 / 12	1
47118	3/4"	12"	10"	1 / 12	1
47122	3/4"	18"	16"	1 / 12	1
47130	7/8"	12"	10"	1 / 12	1
47134	7/8"	17 3/4"	15 3/4"	1 / 12	1
47138	1"	12"	10"	1 / 12	1
47142	1"	17 3/4"	15 3/4"	1 / 12	1

■ SDS Plus® Masonry Drills

Bulk - 25 per Bulk Box

Product	Drill Diameter	Overall Length	Usable Length	Box/Case
47202	5/32"	6"	4"	1 / 4
47204	3/16"	4"	2"	1 / 4
47206	3/16"	6"	4"	1 / 4
47208	3/16"	8"	6"	1 / 4
47232	1/4"	4"	2"	1 / 4
47234	1/4"	6"	4"	1 / 4
47236	1/4"	8"	6"	1 / 4
47252	5/16"	6"	4"	1 / 4
47260	3/8"	6"	4"	1 / 4
47278	1/2"	6"	4"	1 / 4



D SDS1 - Masonry Drill Display



■ SDS Plus® Masonry 5 Pc. Drill Set

- Plastic re-usable drill index.
- Bits clearly visible.

Contains the following drills:
3/16" x 6", 1/4" x 4", 1/4" x 6",
3/8" x 6", 1/2" x 6"



Product	Description	Box/Case	Qty.
47190	SDS Plus® 5 Pc. Set	1 / 12	1



Size: 22"W, 24"H



SDS Max® and Spline Carbide Hammer Drill Bits

■ SDS Max® & Spline Carbide Drill Bits

- Meets all ANSI specifications.
- Tungsten carbide head.
- Chrome vanadium steel body.
- Copper-silver brazing.

■ SDS Max® - 4-Cutter Head

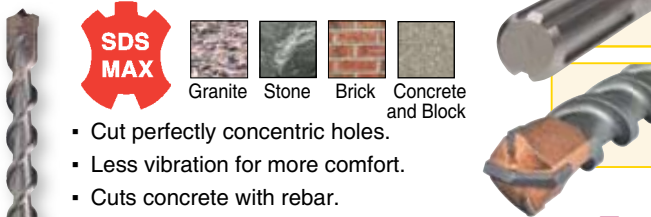

SDS MAX

Granite Stone Brick Concrete and Block

- Cut perfectly concentric holes.
- Less vibration for more comfort.
- Cuts concrete with rebar.

Hang Tab Product	Drill Dia.	Overall Length	Usable Length	Box/Case	Qty.
48110	1/2"	14-1/2"	9-1/2"	1 / 5	1
48112	1/2"	22-1/2"	17-1/2"	1 / 5	1
48114	5/8"	14-1/2"	9-1/2"	1 / 5	1
48116	5/8"	22-1/2"	17-1/2"	1 / 5	1
48122	3/4"	14-1/2"	9-1/2"	1 / 5	1
48124	3/4"	22-1/2"	17-1/2"	1 / 5	1
48132	7/8"	14-1/2"	9-1/2"	1 / 5	1
48134	7/8"	22-1/2"	17-1/2"	1 / 5	1
48138	1"	14-1/2"	9-1/2"	1 / 5	1
48140	1"	22-1/2"	17-1/2"	1 / 5	1
48156	1-1/4"	22-1/2"	17-1/2"	1 / 5	1
48162	1-3/8"	22-1/2"	17-1/2"	1 / 5	1
48168	1-1/2"	22-1/2"	17-1/2"	1 / 5	1

D MAX - SDS Max® 4-Cutter Head Display
Size: 26"W x 28½"H

■ Spline - 4-Cutter Head

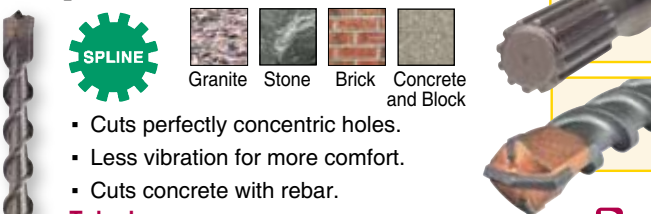

SPLINE

Granite Stone Brick Concrete and Block

- Cuts perfectly concentric holes.
- Less vibration for more comfort.
- Cuts concrete with rebar.

Product	Drill Dia.	Overall Length	Usable Length	Box/Case	Qty.
48300	1/2"	14-1/2"	9-1/2"	1 / 5	1
48301	1/2"	22-1/2"	17-1/2"	1 / 5	1
48302	5/8"	14-1/2"	9-1/2"	1 / 5	1
48304	5/8"	22-1/2"	17-1/2"	1 / 5	1
48310	3/4"	14-1/2"	9-1/2"	1 / 5	1
48314	3/4"	22-1/2"	17-1/2"	1 / 5	1
48318	7/8"	14-1/2"	9-1/2"	1 / 5	1
48320	7/8"	22-1/2"	17-1/2"	1 / 5	1
48322	1"	14-1/2"	9-1/2"	1 / 5	1
48324	1"	22-1/2"	17-1/2"	1 / 5	1
48334	1-1/4"	22-1/2"	17-1/2"	1 / 5	1
48338	1-3/8"	22-1/2"	17-1/2"	1 / 5	1
48340	1-1/2"	22-1/2"	17-1/2"	1 / 5	1

D SPL - Spline 4-Cutter Head Display
Size: 26"W x 28½"H

■ SDS Max® Chisels

- Chrome molybdenum alloy-steel.



SDS MAX

D MXC - SDS Max® Chisel Display
Display contains 2 of each chisel listed below.
Size: 8"W, 25"H

Product	Description	Size	Box/Case
48080	Point Chisel	12"	1 / 5
48082	Flat Chisel	1" x 12"	1 / 5
48083	Flat Chisel	1" x 18"	1 / 5
48084	Wide Chisel	2" x 14"	1 / 5

Carded

■ Glass and Tile Carbide Drills



IVY Classic

1/2" 3/8" Shank

Ceramic Tile Glass Marble

- Tungsten carbide spear points cut round holes without chipping or breaking the material.
- For drilling glass, ceramic and marble tile.
- For rotation only - not for percussion drilling.
- Slow drilling speeds are recommended.

Carded Product	Diameter	Shank	Length	Box/Case	Qty.
10360	1/8"	1/8"	2-5/8"	4 / 16	4
10362	3/16"	3/16"	2-5/8"	4 / 16	4
10364	1/4"	1/4"	2-5/8"	4 / 16	4
10366	5/16"	1/4"	2-5/8"	4 / 16	4
10368	3/8"	3/8"	2-5/8"	4 / 16	4
10370	1/2"	3/8"	2-5/8"	4 / 16	4
10372	5 Pc. Set - Contains: 1/8", 3/16", 1/4", 5/16", and 3/8"			4 / 16	4

D GBD - Glass & Tile Drill Display



IVY Classic

Tungsten Carbide Tipped

For drilling glass, ceramic & marble tile

Glass and Tile Drills

1/8" 3/16" 1/4" 5/16" 3/8" 1/2"

5 Pc. Glass & Tile Carbide Drill Set

Size: 17"W 10"H

Professional Carbide Router Bits



Professional Carbide Router Bits

- Cuts plywood, composition board, and hard and soft woods.

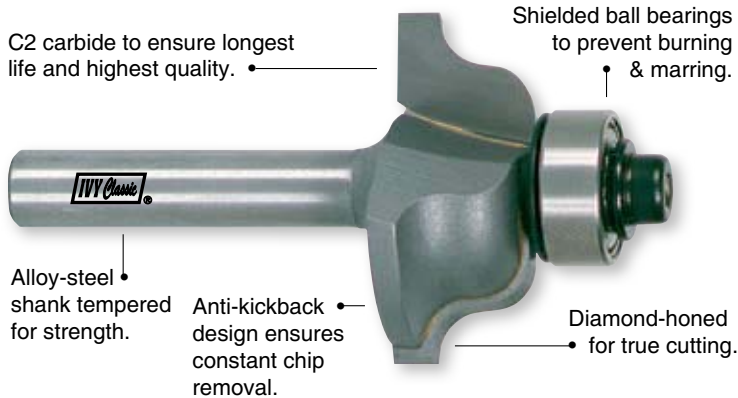

Dimension Key

- D - Cutting Depth
- W - Width of Cut
- L - Overall Length
- R - Radius of Curve

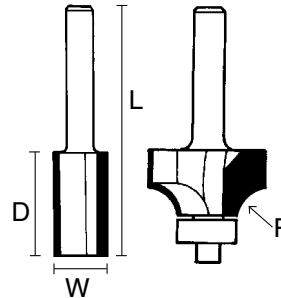

Router bits individually packed in re-usable plastic pouches.

■ Straight Router Bit

- 2 Flutes
- 1/4" Shank.



Product	W	D	L	Box/Case
10804	1/4"	1"	2-1/4"	1 / 15
10806	5/16"	1"	2-1/4"	1 / 15
10808	3/8"	1"	2-3/16"	1 / 15
10810	1/2"	1"	2-3/16"	1 / 15
10812	5/8"	1"	2-3/16"	1 / 15
10814	3/4"	1"	2-3/16"	1 / 15



■ Laminate Trim Bit

- 1/4" Shank
- BB = Replacement Ball Bearing



Product	W	D	L	BB	Box/Case
2 Flutes With Ball Bearing Guide					
10816	3/8"	1"	2-1/4"	10962	1 / 15
10818	1/2"	5/8"	1-7/8"	10964	1 / 15
10820	1/2"	1"	2-1/4"	10964	1 / 15
3 Flutes With Ball Bearing Guide					
10822	1/2"	1"	2-1/4"	10964	1 / 15



■ Laminate Trim Bit

- 2 Flutes with Ball Bearing
- 1/4" Shank
- Replacement Bearing - 10964

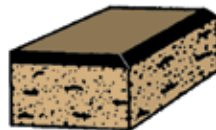

Product	W	D	L	Bevel	Box/Case
10824	7/8"	15/32"	2-1/4"	22°	1 / 15
10828	15/16"	15/32"	2-1/4"	25°	1 / 15



■ Pattern Cutting Bit (Flush Trim Bit)

- 2 Flutes with Upper Ball Bearing
- 1/4" Shank
- BB = Replacement Ball Bearing.

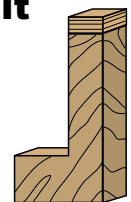

Product	W	D	L	BB	Box/Case
10900	1/2"	1"	2-11/16"	10965	1 / 15
10902	5/8"	1"	2-5/8"	10966	1 / 15
10904	3/4"	1"	2-3/4"	10967	1 / 15



■ 90° V Groove Bit

- 2 Flutes
- 1/4" Shank



Product	W	D	L	Box/Case
10830	3/8"	1/2"	1-3/4"	1 / 15



■ Panel Pilot Bit

- Single Flute
- 1/4" Shank

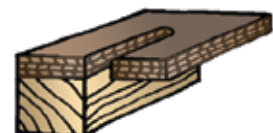

Product	W	D	L	Box/Case
10832	1/4"	3/4"	2-5/8"	1 / 15
10834	3/8"	1"	2-7/8"	1 / 15



■ Dimension Key:

W - Width of Cut

D - Cutting Depth

L - Overall Length

R - Radius of Curve

■ Plunge Ogee Bit



- 2 Flutes
- 1/4" Shank



Product	W	D	L	R	Box/Case
10836	13/32"	3/8"	1-3/4"	1/16"	1 / 15
10838	21/32"	1/2"	1-7/8"	1/8"	1 / 15

■ Beading Bit

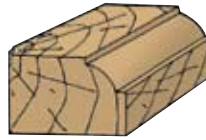

- 2 Flutes with Ball Bearing
- 1/4" Shank
- Replacement bearing - 10962



Product	W	D	L	R	Box/Case
10884	1"	17/32"	2-3/16"	1/4"	1 / 15
10886	1-1/2"	3/4"	2-7/16"	1/2"	1 / 15

■ Roman Ogee Bit

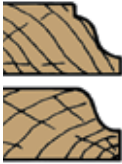

- 2 Flutes with Ball Bearing
- 1/4" Shank
- Replacement Bearing 10962



Product	W	D	L	R	Box/Case
10842	1-1/8"	1/2"	2-1/8"	5/32"	1 / 15
10844	1-1/2"	11/16"	2-3/8"	1/4"	1 / 15

■ Plunge Beading Bit



- 2 Flutes
- 1/4" Shank



Product	W	D	L	R	Box/Case
10840	3/8"	3/8"	1-3/4"	1/8"	1 / 15

■ Classical Roman Ogee Bit



- 2 Flutes with Ball Bearing
- 1/4" Shank
- Replacement Bearing - 10962



Product	W	D	L	R	Box/Case
10892	1-1/8"	1/2"	2-1/8"	1/8"	1 / 15
10894	1-1/4"	5/8"	2-1/4"	3/16"	1 / 15
10896	1-1/2"	3/4"	2-1/4"	1/4"	1 / 15

■ Edge Beading Bit

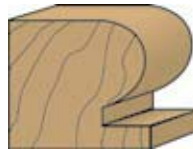

- 2 Flutes with Ball Bearing
- 1/4" Shank
- Replacement Bearing - 10964



Product	W	D	L	R	Box/Case
10916	7/8"	9/16"	2-1/4"	1/8"	1 / 15
10918	1"	11/16"	2-5/16"	3/16"	1 / 15
10920	1-1/8"	3/4"	2-7/16"	1/4"	1 / 15

■ Cove Bit



- 2 Flutes with Ball Bearing
- 1/4" Shank
- Replacement Bearing - 10962



Product	W	D	L	R	Box/Case
10854	7/8"	1/2"	2-3/32"	1/4"	1 / 15
10856	1-1/8"	9/16"	2-3/16"	3/8"	1 / 15
10858	1-3/8"	5/8"	2-5/16"	1/2"	1 / 15

■ Rounding Over Bit

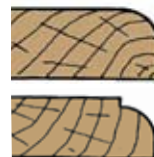

- 2 Flutes with Ball Bearing
- 1/4" Shank
- Replacement Bearing - 10964



Product	W	D	L	R	Box/Case
10846	1"	17/32"	2-3/16"	1/4"	1 / 15
10848	1-1/8"	5/8"	2-1/4"	5/16"	1 / 15
10850	1-1/4"	21/32"	2-5/16"	3/8"	1 / 15
10852	1-1/2"	3/4"	2-7/16"	1/2"	1 / 15

■ 45° Chamfer Bit



- 2 Flutes with Ball Bearing
- 1/4" Shank
- Replacement bearing - 10964



Product	W	D	L	Box/Case
10870	1-1/4"	19/32"	2-3/16"	1 / 15

■ 25° Panel Raising Bit

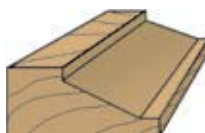

- 2 Flutes with Ball Bearing
- 1/4" Shank
- Replacement bearing - 10964



Product	W	D	L	Box/Case
10910	1-5/8"	1/2"	1-3/4"	1 / 15

■ Core Box Bit



- 2 Flutes
- 1/4" Shank



Product	W	D	L	R	Box/Case
10860	1/4"	3/8"	1-9/16"	1/8"	1 / 15
10862	3/8"	3/8"	1-9/16"	3/16"	1 / 15
10864	1/2"	3/8"	1-9/16"	1/4"	1 / 15
10866	5/8"	1/2"	1-3/4"	5/16"	1 / 15
10868	3/4"	1/2"	1-13/16"	3/8"	1 / 15

■ Hinge Mortise Bit



- 2 Flutes
- 1/4" Shank



Product	W	D	L	Box/Case
10874	1/2"	1/2"	2"	1 / 15
10876	5/8"	1/2"	2"	1 / 15

■ T & G Slot Bit

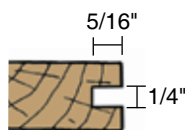

For slotting wood flooring. Ideal for making repairs and creating special designs.

- 2 Flutes with Ball Bearing
- 1/4" Shank
- Replacement bearing - 10966



Product	W	D	L	Box/Case
10959	1-1/4"	1/4"	1-3/4"	1 / 15

■ 3/8" Rabbeting Bit

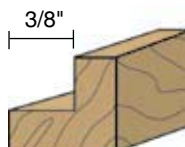

- 2 Flutes with Ball Bearing
- 1/4" Shank
- Replacement bearing - 10964



Product	W	D	L	Box/Case
10872	1-1/4"	1/2"	2-1/8"	1 / 15

■ 104° Dovetail Bit



- 2 Flutes
- 1/4" Shank



Product	W	D	L	Box/Case
10878	1/2"	15/32"	1-3/4"	1 / 15

■ Keyhole Bit



- 2 Flutes
- 1/4" Shank



Product	W	D	L	Box/Case
10888	3/8"	7/16"	1-7/8"	1 / 15

■ Router Collet Adapter

- To use 1/4" shank bits on a 1/2" router.
- Adapts router bit with 1/4" shank to fit on 1/2" router. Works with all IVY Classic 1/4" shank router bits.



Product	Description	Length	Box/Case
10973	Adapts 1/4" to 1/2"	1"	1 / 15

■ Three-Wing Slotted Cutters

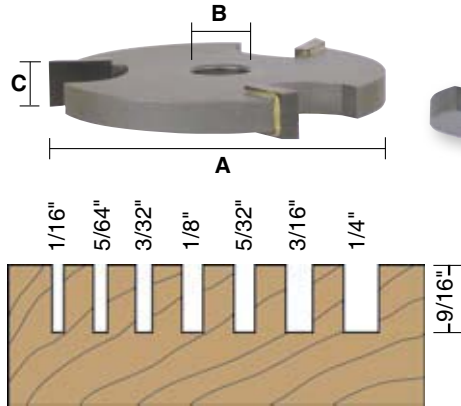

Note: Three-wing slotted cutters & arbor assembly are sold separately.

Product	A	B	C	Box/Case
10928	2"	8mm	1/16"	1 / 15
10930	2"	8mm	5/64"	1 / 15
10932	2"	8mm	3/32"	1 / 15
10934	2"	8mm	1/8"	1 / 15
10936	2"	8mm	5/32"	1 / 15
10938	2"	8mm	3/16"	1 / 15
10940	2"	8mm	1/4"	1 / 15

■ Arbor Assembly

This arbor assembly can be used with any of the IVY Classic three wing slotted cutters.

- Replacement bearing 10970
- 1/4" Shank

Product	Thread	D	L	Box/Case
10922	5/16"-24NF	2"	2-3/8"	1 / 15



■ Steel Ball Bearings

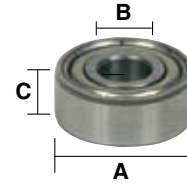

Product	A	B	C	Box/Case
10962	3/8"	3/16"	1/8"	1 / 15
10964	1/2"	3/16"	3/16"	1 / 15
10965	1/2"	1/4"	3/16"	1 / 15
10966	5/8"	1/4"	3/16"	1 / 15
10967	3/4"	1/4"	9/32"	1 / 15
10970	22mm	8mm	7mm	1 / 15

D CRD1 - 35 Pc. Carbide Router Bit Display

Product	Description	Qty.
10804	1/4" Straight 2 Flute	1
10806	5/16" Straight 2 Flute	1
10808	3/8" Straight 2 Flute	1
10810	1/2" Straight 2 Flute	1
10812	5/8" Straight 2 Flute	1
10814	3/4" Straight 2 Flute	1
10816	3/8" Laminate 2 Flute	1
10818	1/2" Laminate 2 Flute	1
10820	1/2" Laminate 2 Flute	1
10822	1/2" Laminate 3 Flute	1
10824	22° Laminate 2 Flute	1
10828	25° Laminate 2 Flute	1
10830	90° V Groove 2 Flute	1
10832	1/4" Panel 1 Flute	1
10842	5/32" Roman Ogee 2 Flute	1
10844	1/4" Roman Ogee 2 Flute	1
10846	1/4" Rounding Over 2 Flute	1
10848	5/16" Rounding Over 2 Flute	1
10850	3/8" Rounding Over 2 Flute	1
10852	1/2" Rounding Over 2 Flute	1
10854	1/4" Cove 2 Flute	1
10856	3/8" Cove 2 Flute	1
10858	1/2" Cove 2 Flute	1
10860	1/4" Core Box 2 Flute	1
10862	3/8" Core Box 2 Flute	1
10864	1/2" Core Box 2 Flute	1
10866	5/8" Core Box 2 Flute	1
10868	3/4" Core Box 2 Flute	1
10870	45° Chamfer 2 Flute	1
10872	3/8" Rabbeting 2 Flute	1
10874	1/2" Hinge Mortise 2 Flute	1
10876	5/8" Hinge Mortise 2 Flute	1
10878	104° Dovetail 2 Flute	1
10884	1/4" Beading 2 Flute	1
10886	1/2" Beading 2 Flute	1



Each display includes a free lockable wooden router bit merchandiser

Size:
24"W
31"H

D CRD2 - 35 Pc. Carbide Router Bit Display

Product	Description	Qty.
10816	3/8" Laminate 2 Flute	1
10818	1/2" Laminate 2 Flute	1
10820	1/2" Laminate 2 Flute	1
10822	1/2" Laminate 3 Flute	1
10834	3/8" Panel Pilot	1
10836	1/16" Plunge Ogee	1
10838	1/8" Plunge Ogee	1
10840	1/8" Plunge Beading	1
10888	3/8" Keyhole 2 Flute	1
10892	1/8" Classic Ogee	1
10894	3/16" Classic Ogee	1
10896	1/4" Classic Ogee	1
10900	1/2" Pattern Cutting	1
10902	5/8" Pattern Cutting	1
10904	3/4" Pattern Cutting	1
10910	25° Panel Raising	1
10916	1/8" Edge Beading	1
10918	3/16" Edge Beading	1
10920	1/4" Edge Beading	1
10922	5/16" - 24NF Arbor	1
10928	1/16" 3-Wing Slotted Cutter	1
10930	5/64" 3-Wing Slotted Cutter	1
10932	3/32" 3-Wing Slotted Cutter	1
10934	1/8" 3-Wing Slotted Cutter	1
10936	5/32" 3-Wing Slotted Cutter	1
10938	3/16" 3-Wing Slotted Cutter	1
10940	1/4" 3-Wing Slotted Cutter	1
10959	T & G Slot Bit	1
10962	3/8"x3/16"x1/8" Ball Bearing	1
10964	1/2"x3/16"x3/16" Ball Bearing	1
10965	1/2"x1/4"x3/16" Ball Bearing	1
10966	5/8"x1/4"x3/16" Ball Bearing	1
10967	3/4"x1/4"x9/32" Ball Bearing	1
10970	22mmx8mmx7mm Ball Bearing	1
10973	Router Collet Adapter	1

All IVY Classic insert bits are manufactured from **S-2 Tool Steel**.
The Rockwell Hardness is **60-64 HRC**.

Insert and Power Bits

Three Packaging Options

Our insert bits, holders and setters come in three different packaging options.

Bulk - Sealed plastic bags with clearly marked labels.



Carded - Snap lock boxes with color coded labels, hang tab and individual barcode. Or sturdy, labeled hang tabs.



Hex Jars  - Clear, heavy plastic jars with lids and labels.



Phillips® Insert Bits



- S-2 Tool Steel
- Rockwell Hardness 60-64

Bulk

Product	Length	Size	Box/Case
45000	1"	#1	100 / 1000
45002	1"	#2	100 / 1000
45004	1"	#3	100 / 1000



45006	1"	#2 Reduced Shank	100 / 1000
-------	----	------------------	------------

Carded

Product	Length	Size	Card Qty.	Box/Case
44000	1"	#1	2	10 / 50
44004	1"	#2	2	10 / 50
44006	1"	#2	6	10 / 50
44008	1"	#2	20	24 / 72
44012	1"	#3	2	10 / 50
44016	1"	#2 Reduced	2	10 / 50
44018	1"	#2 Reduced	6	10 / 50
44020	1"	#2 Reduced	20	24 / 72



Phillips® Insert Bit Jars

Product	Contains Bit #	Length	Size	Jar Qty.
45090	45002	1"	#2	500
45091	45002	1"	#2	1000
45092	45000	1"	#1	500
45094	45004	1"	#3	500
45095	45006	1"	#2 Reduced	500



Phillips® Power Bits

- S-2 Tool Steel
- Rockwell Hardness 60-64



Bulk

Product	Length	Size	Box/Case
45008	2"	#1	50 / 250
45010	2"	#2	50 / 250
45012	2"	#3	50 / 250
45124	2-3/4"	#1	50 / 250
45014	2-3/4"	#2	50 / 250
45156	2-3/4"	#3	50 / 250
45126	3-1/2"	#1	25 / 250
45016	3-1/2"	#2	25 / 250
45158	3-1/2"	#3	25 / 250
45144	4"	#2	10 / 100
45148	6"	#2	10 / 100

Carded

Product	Length	Size	Card Qty.	Box/Case
44024	2"	#1	1	10 / 50
44028	2"	#2	1	10 / 50
44030	2"	#2	10	24 / 72
44034	2"	#3	1	10 / 50
44038	2-3/4"	#1	1	10 / 50
44040	2-3/4"	#2	1	10 / 50
44042	2-3/4"	#3	1	10 / 50
44044	3-1/2"	#1	1	10 / 50
44046	3-1/2"	#2	1	10 / 50
44048	3-1/2"	#3	1	10 / 50
44052	4"	#2	1	5 / 50
44056	6"	#2	1	5 / 50



Phillips® Power Bit Jars

Product	Contains Bit #	Length	Size	Jar Qty.
45962	45008	2"	#1	250
45096	45010	2"	#2	250
45963	45012	2"	#3	250
45964	45014	2-3/4"	#2	150
45965	45016	3-1/2"	#2	100



Phillips® Drywall Screw Setter



- S-2 Tool Steel
- Rockwell Hardness 60-64

Bulk

Product	Length	Size	Box/Case
45058	1"	#2	20 / 100

Carded - One per card

Product	Length	Size	Box/Case
44022	1"	#2	10 / 50



Phillips® Drywall Screw Setter Jar

Product	Contains Bit #	Length	Size	Jar Qty.
45088	45058	1"	#2	100





Insert and Power Bits

■ Phillips® ACR® Insert Bits

ACR® bits reduce cam-out stripping of the screw & bit.
Forged ribs grip the screw providing greater torque.

- S-2 Tool Steel
- Rockwell Hardness 60-64

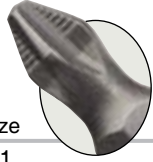

Bulk

Product	Length	Size	Box/Case
45700	1"	#1	100 / 300
45702	1"	#2	100 / 300
45704	1"	#3	100 / 300



45703	1"	#2 Reduced	100 / 300
-------	----	------------	-----------



45706	2"	#1	50 / 150
45708	2"	#2	50 / 150
45710	2"	#3	50 / 150

Carded

Product	Length	Size	Card Qty.	Box/Case
44066	1"	#1	1	10 / 50
44068	1"	#2	1	10 / 50
44070	1"	#2	20	24 / 72
44072	1"	#2 Reduced	1	10 / 50
44076	1"	#3	1	10 / 50
44078	2"	#1	1	10 / 50
44082	2"	#2	1	10 / 50
44086	2"	#3	1	10 / 50



■ JAR Phillips® ACR® Insert Bit Jars

Product	Contains Bit #	Length	Size	Jar Qty.
45074	45702	1"	#2	500
45075	45703	1"	#2 Reduced	500
45076	45708	2"	#2	250



■ Slotted Insert Bits



- S-2 Tool Steel
- Rockwell Hardness 60-64

Bulk

Product	Length	Size	Box/Case
45019	1"	#4-5	50 / 250
45020	1"	#6-8	50 / 250
45022	1"	#8-10	50 / 250
45024	1"	#10-12	50 / 250

Carded - One per card

Product	Length	Size	Box/Case
44200	1"	#4-5	10 / 50
44202	1"	#6-8	10 / 50
44204	1"	#8-10	10 / 50
44206	1"	#10-12	10 / 50



■ Slotted Power Bits

- S-2 Tool Steel
- Rockwell Hardness 60-64



Bulk

Product	Length	Size	Box/Case
45248	2"	#6-8	25 / 250
45250	2"	#8-10	25 / 250
45260	2"	#10-12	25 / 250

Carded - One per card

Product	Length	Size	Box/Case
44210	2"	#6-8	10 / 50
44212	2"	#8-10	10 / 50
44214	2"	#10-12	10 / 50



■ Slotted Power Bits with Finder

- S-2 Tool Steel
- Rockwell Hardness 60-64



Bulk

Product	Length	Size	Box/Case
45266	2"	#6-8	10 / 100
45268	2"	#8-10	10 / 100
45270	2"	#10-12	10 / 100

Carded - One per card

Product	Length	Size	Box/Case
44230	2"	#6-8	10 / 100
44232	2"	#8-10	10 / 100
44234	2"	#10-12	10 / 100



■ Slotted ACR® Insert Bits

- ACR® bits reduce cam-out stripping of the screw & bit.
- Forged ribs grip the screw providing greater torque.
- S-2 Tool Steel.
- Rockwell Hardness 60-64.



Bulk

Product	Length	Size	Box/Case
45742	1"	#6 - 8	50 / 150
45744	1"	#8 - 10	50 / 150
45746	1"	#10 - 12	50 / 150

Carded - One per card

Product	Length	Size	Box/Case
44238	1"	#6 - 8	10 / 50
44240	1"	#8 - 10	10 / 50
44242	1"	#10 - 12	10 / 50



■ Square Insert Bits



- S-2 Tool Steel
- Rockwell Hardness 60-64

Bulk

Product	Length	Size	Box/Case
45170	1"	#0	50 / 250
45034	1"	#1	50 / 250
45036	1"	#2	50 / 250
45176	1"	#3	50 / 250

Carded

Product	Length	Size	Card Qty.	Box/Case
44100	1"	#0	1	10 / 50
44104	1"	#1	1	10 / 50
44108	1"	#2	2	10 / 50
44110	1"	#2	6	10 / 50
44112	1"	#2	20	24 / 72
44118	1"	#3	1	10 / 50



JAR Square Insert Bit Jars

Product	Contains Bit #	Length	Size	Jar Qty.
45071	45034	1"	#1	500
45070	45036	1"	#2	500



■ Square Power Bits

- S-2 Tool Steel
- Rockwell Hardness 60-64



Bulk

Product	Length	Size	Box/Case
45182	2"	#1	25 / 250
45200	2"	#2	25 / 250
45220	2"	#3	25 / 250
45184	2-3/4"	#1	25 / 250
45202	2-3/4"	#2	25 / 250
45222	2-3/4"	#3	25 / 250
45232	6"	#2	10 / 100

Carded

Product	Length	Size	Card Qty.	Box/Case
44136	2"	#1	1	10 / 50
44140	2"	#2	1	10 / 50
44142	2"	#2	10	24 / 72
44146	2"	#3	1	10 / 50
44150	2-3/4"	#1	1	10 / 50
44152	2-3/4"	#2	1	10 / 50
44154	2-3/4"	#3	1	10 / 50
44164	6"	#2	1	5 / 50



JAR Square Power Bit Jars

Product	Contains Bit #	Length	Size	Jar Qty.
45967	45182	2"	#1	250
45072	45200	2"	#2	250
45968	45202	2-3/4"	#2	150



■ Square Drive Screw Setter



- S-2 Tool Steel
- Rockwell Hardness 60-64

Bulk

Product	Length	Size	Box/Case
45175	1"	#2	20 / 100

Carded - One per card

Product	Length	Size	Box/Case
44116	1"	#2	10 / 50



JAR Square Screw Setter Jar

Product	Contains Bit #	Length	Size	Jar Qty.
45976	45175	1"	#2	100



■ Double-End Bits

- S-2 Tool Steel
- Rockwell Hardness 60-64



Bulk

Product	Length	Size	Box/Case
45275	2"	#1 Ph. x #2 Ph.	25 / 250
45277	2"	#2 Ph. x #2 Ph.	25 / 250

Carded - One per card

Product	Length	Size	Box/Case
44256	2"	#1 Ph. x #2 Ph.	10 / 50
44258	2"	#2 Ph. x #2 Ph.	10 / 50



Bulk

Product	Length	Size	Box/Case
45274	2"	#1 Ph. x #5-6 Sl.	25 / 250
45276	2"	#2 Ph. x #6-8 Sl.	25 / 250
45284	2"	#3 Ph. x #8-10 Sl.	25 / 250

Carded - One per card

Product	Length	Size	Box/Case
44260	2"	#1 Ph. x #5-6 Sl.	10 / 50
44262	2"	#2 Ph. x #6-8 Sl.	10 / 50
44264	2"	#3 Ph. x #8-10 Sl.	10 / 50



Bulk

Product	Length	Size	Box/Case
45278	2"	#2 Ph. x #2 Sq.	25 / 250

Carded - One per card

Product	Length	Size	Box/Case
44266	2"	#2 Ph. x #2 Sq.	10 / 50



JAR Double-End Insert Bit Jars

Product	Contains Bit #	Size	Jar Qty.
45959	45277	#2 Ph. x #2 Ph.	250
45960	45276	#2 Ph. x #6-8 Sl.	250
45961	45278	#2 Ph. x #2 Sq.	250





Insert and Power Bits

■ Phillips Square-Driv® Bit

- S-2 Tool Steel
- Rockwell Hardness 60-64



Bulk

Product	Length	Size	Box/Case
45809	1"	#2 Ph. - #2 Sq.	50 / 250
45810	2"	#2 Ph. - #2 Sq.	25 / 250

Carded - One per card

Product	Length	Size	Box/Case
44250	1"	#2 Ph. - #2 Sq.	10 / 50
44252	2"	#2 Ph. - #2 Sq.	10 / 50

■ JAR Phillips Square-Driv® Bit Jar

Product	Contains Bit #	Length	Size	Jar Qty.
45970	45809	1"	#2	150
45971	45810	2"	#2	100



■ Torx® Insert Bits



- S-2 Tool Steel
- Rockwell Hardness 60-64

Bulk

Product	Length	Size	Box/Case
45290	1"	T6	25 / 250
45292	1"	T7	25 / 250
45294	1"	T8	25 / 250
45296	1"	T9	25 / 250
45298	1"	T10	25 / 250
45300	1"	T15	25 / 250
45302	1"	T20	25 / 250
45304	1"	T25	25 / 250
45306	1"	T27	25 / 250
45308	1"	T30	25 / 250
45310	1"	T40	25 / 250

Carded

Product	Length	Size	Card Qty.	Box/Case
44306	1"	T6	1	10 / 50
44308	1"	T7	1	10 / 50
44310	1"	T8	1	10 / 50
44312	1"	T9	1	10 / 50
44314	1"	T10	1	10 / 50
44316	1"	T15	1	10 / 50
44318	1"	T20	1	10 / 50
44320	1"	T25	1	10 / 50
44322	1"	T25	6	10 / 50
44324	1"	T27	1	10 / 50
44326	1"	T30	1	10 / 50
44328	1"	T40	1	10 / 50

■ JAR Torx® Insert Bit Jars

Product	Contains Bit #	Length	Size	Jar Qty.
45936	45298	1"	T10	200
45937	45300	1"	T15	200
45938	45302	1"	T20	200
45939	45304	1"	T25	200



■ Torx® Power Bits

- S-2 Tool Steel
- Rockwell Hardness 60-64



Bulk

Product	Length	Size	Box/Case
45316	2"	T10	25 / 150
45318	2"	T15	25 / 150
45320	2"	T20	25 / 150
45322	2"	T25	25 / 150
45324	2"	T27	25 / 150
45326	2"	T30	25 / 150
45328	2"	T40	25 / 150

Carded - One per card

Product	Length	Size	Box/Case
44344	2"	T10	10 / 50
44346	2"	T15	10 / 50
44348	2"	T20	10 / 50
44350	2"	T25	10 / 50
44352	2"	T27	10 / 50
44354	2"	T30	10 / 50
44356	2"	T40	10 / 50



■ JAR Torx® Power Bit Jars

Product	Contains Bit #	Length	Size	Jar Qty.
45943	45316	2"	T10	100
45944	45318	2"	T15	100
45945	45320	2"	T20	100
45946	45322	2"	T25	100



■ Torx® Tamper Resistant Insert Bits



- S-2 Tool Steel
- Rockwell Hardness 60-64

Bulk

Product	Length	Size	Box/Case
45400	1"	T8	10 / 100
45402	1"	T9	10 / 100
45404	1"	T10	10 / 100
45406	1"	T15	10 / 100
45408	1"	T20	10 / 100
45410	1"	T25	10 / 100
45412	1"	T27	10 / 100
45414	1"	T30	10 / 100
45416	1"	T40	10 / 100

Carded - One per card

Product	Length	Size	Box/Case
44378	1"	T8	10 / 50
44380	1"	T9	10 / 50
44382	1"	T10	10 / 50
44384	1"	T15	10 / 50
44386	1"	T20	10 / 50
44388	1"	T25	10 / 50
44390	1"	T27	10 / 50
44392	1"	T30	10 / 50
44394	1"	T40	10 / 50



■ Hex Insert Bits



- S-2 Tool Steel
- Rockwell Hardness 60-64

Bulk

Product	Length	Size	Box/Case
45354	1"	5/64"	10 / 100
45356	1"	3/32"	10 / 100
45358	1"	7/64"	10 / 100
45360	1"	1/8"	10 / 100
45361	1"	9/64"	10 / 100
45362	1"	5/32"	10 / 100
45364	1"	3/16"	10 / 100
45366	1"	7/32"	10 / 100
45368	1"	1/4"	10 / 100

Carded - One per card

Product	Length	Size	Box/Case
44404	1"	5/64"	10 / 50
44406	1"	3/32"	10 / 50
44408	1"	7/64"	10 / 50
44410	1"	1/8"	10 / 50
44412	1"	9/64"	10 / 50
44414	1"	5/32"	10 / 50
44416	1"	3/16"	10 / 50
44418	1"	7/32"	10 / 50
44420	1"	1/4"	10 / 50



■ Hex Tamper Resistant Insert Bits



- S-2 Tool Steel
- Rockwell Hardness 60-64

Bulk

Product	Length	Size	Box/Case
45432	1"	3/32"	10 / 100
45434	1"	1/8"	10 / 100
45436	1"	9/64"	10 / 100
45438	1"	5/32"	10 / 100
45440	1"	3/16"	10 / 100
45442	1"	7/32"	10 / 100
45444	1"	1/4"	10 / 100
45446	1"	5/16"	10 / 100

Carded - One per card

Product	Length	Size	Box/Case
44458	1"	3/32"	10 / 50
44460	1"	1/8"	10 / 50
44462	1"	9/64"	10 / 50
44464	1"	5/32"	10 / 50
44466	1"	3/16"	10 / 50
44468	1"	7/32"	10 / 50
44470	1"	1/4"	10 / 50
44472	1"	5/16"	10 / 50



■ Spanner Insert Bits



- S-2 Tool Steel
- Rockwell Hardness 60-64

Bulk

Product	Length	Size	Box/Case
45386	1"	#6	10 / 100
45388	1"	#8	10 / 100
45390	1"	#10	10 / 100
45392	1"	#12	10 / 100

Carded - One per card

Product	Length	Size	Box/Case
44502	1"	#6	10 / 50
44504	1"	#8	10 / 50
44506	1"	#10	10 / 50
44508	1"	#12	10 / 50



■ Tri-Wing® Insert Bits



- S-2 Tool Steel
- Rockwell Hardness 60-64

Bulk

Product	Length	Size	Box/Case
45422	1"	#1	10 / 100
45424	1"	#2	10 / 100
45426	1"	#3	10 / 100
45427	1"	#4	10 / 100
45428	1"	#5	10 / 100

Carded - One per card

Product	Length	Size	Box/Case
44520	1"	#1	10 / 50
44522	1"	#2	10 / 50
44524	1"	#3	10 / 50
44526	1"	#4	10 / 50
44528	1"	#5	10 / 50



■ Pozidriv® Insert Bits



- S-2 Tool Steel
- Rockwell Hardness 60-64

Bulk

Product	Length	Size	Box/Case
45780	1"	#0	10 / 100
45782	1"	#1	10 / 100
45784	1"	#2	10 / 100
45786	1"	#3	10 / 100

Carded - One per card

Product	Length	Size	Box/Case
44512	1"	#0	10 / 50
44514	1"	#1	10 / 50
44516	1"	#2	10 / 50
44518	1"	#3	10 / 50





Mega-Magnetic® Bit Holders

MegaMAGNETIC®

Patented in the USA

40x the Pulling Power

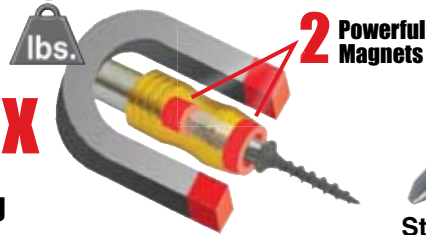

Works with all 1" insert bits.

Step 1
Insert your bit.

Step 2 Magnet #1
holds and
magnetizes the bit.

Step 3
Attach
fastener.

Step 4
Slide Mega-MAGNETIC®
sleeve down and magnet
#2 powerfully holds your
fastener in place!

3" Mega-Magnetic® Bit Holder

Patented in the USA



- One piece stainless steel construction.
- 1/4" hex power shank.

25 per Display Box - A steel plate in the bottom of the box demonstrates the pulling power of the Mega-Magnetic® Bit Holder.

Display Box - 25 per display box

Product	Length	Shank	Box/Case
45834	3"	1/4"	25 / 100

Carded Product	Length	Shank	Box/Case
44628	3"	1/4"	10 / 50



6" Mega-Magnetic® Flexible Bit Holder



- For hard to reach areas.
- Stainless steel front construction.
- 1/4" hex power shank.

Patented in the USA

Carded Product	Length	Shank	Box/Case
44768	6"	1/4"	5 / 50



15" Mega-Magnetic® Bit Holder



- Ideal for cabinetry work.
- Non-rotating outer sleeve for safety.
- Stainless steel front construction.
- 1/4" hex power shank.

Patented in the USA

Carded Product	Length	Shank	Box/Case
45837	15"	1/4"	6 / 24



23" Mega-Magnetic® Bit Holder



- Non-rotating outer sleeve for safety.
- Stainless steel front construction.
- 1/4" hex power shank.

Patented in the USA

Carded Product	Length	Shank	Box/Case
45838	23"	1/4"	6 / 24



Impact Driver Adapter

Patented in the USA

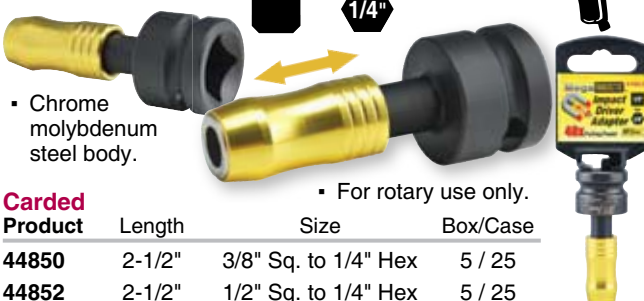

- Chrome molybdenum steel body.

- For rotary use only.

Carded Product	Length	Size	Box/Case
44850	2-1/2"	3/8" Sq. to 1/4" Hex	5 / 25
44852	2-1/2"	1/2" Sq. to 1/4" Hex	5 / 25

SDS® Mega-Magnetic® Bit Holder

Patented in the USA

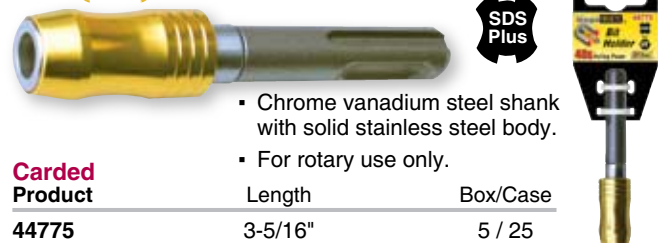

- Chrome vanadium steel shank with solid stainless steel body.
- For rotary use only.

Carded Product	Length	Box/Case
44775	3-5/16"	5 / 25

Magnetic Bit Holders and Drivers



IHM - Mega-Magnetic® Display

Patented in the USA



40x the Pulling Power of Ordinary Magnetic Bit Holders



Size: 10"W, 29"H



Prod.	Description	Qty.
44628	3" Mega-Magnetic® Bit Holder	10
44768	6" Mega-Magnetic® Flexible Bit Holder	5
45837	15" Mega-Magnetic® Bit Holder	2
45838	23" Mega-Magnetic® Bit Holder	2
44775	SDS® Mega-Magnetic® Bit Holder	2
44850	3/8" Mega-Magnetic® Impact Driver Adapter	2
44852	1/2" Mega-Magnetic® Impact Driver Adapter	2
17071	9" Mega-Magnetic® Ratchet Screwdriver	4

1/4" Hex Rapid Reload® Power Bit Holders



- Tapered head allows extension to pass through a 5/8" hole.
- Power bit held in place by ball and spring retention.
- Nickel plated for long life.

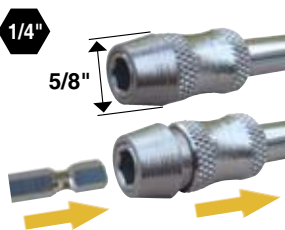

Bulk Product	Length	Box/Case
45636	2-3/8"	10 / 100

Carded - One per card Product	Length	Box/Case
45638	2-3/8"	6 / 24
45640	6"	6 / 24
45642	12"	6 / 24

JAR Rapid Reload Bit Holder Jar

Product	Contains #	Length	Jar Qty.
45078	45636	2-3/8"	30

1/4" Hex Drive Magnetic Bit Holders

- One-piece stainless steel construction with c-ring retainer.



Bulk Product	Length	Size	Box/Case
45050	3"	7/16"	10 / 50
45052	2-3/8"(60mm)	7/16"	10 / 50
45054	6"	7/16"	5 / 50

Carded - One per card

Product	Length	Size	Box/Case
44604	3"	7/16"	5 / 50
44600	2-3/8"(60mm)	7/16"	5 / 50
44608	6"	7/16"	5 / 50

JAR Magnetic Bit Holder Jars

Product	Contains #	Length	Size	Jar Qty.
45098	45050	3"	7/16"	50
45099	45052	2-3/8"(60mm)	7/16"	50

Magnetic Screw Guide Drivers

- Sleeve extends to hold screw in place while fastening.



Bulk Product	Length	Body Dia.	Box/Case
45840	3"	7/16"	10 / 50
45842	5"	7/16"	10 / 50

Carded - One per card

Product	Length	Body Dia.	Box/Case
44620	3"	7/16"	5 / 50
44622	5"	7/16"	5 / 50

JAR Magnetic Screw Guide Driver Jars

Product	Contains #	Length	Size	Jar Qty.
45087	45840	3"	7/16"	50
45089	45842	5"	7/16"	30

1/4" Magnetic Quick Release Holders

- Insert bit held in place by ball and spring retention.
- Pulling back knurled sleeve releases insert bit.



Bulk Product	Length	Body Dia.	Box/Case
45830	3"	9/16"	10 / 50
45832	6"	9/16"	5 / 50

Carded - One per card

Product	Length	Body Dia.	Box/Case
44614	3"	9/16"	5 / 50
44616	6"	9/16"	5 / 50

JAR Magnetic Quick Release Holder Jars

Product	Contains #	Length	Size	Jar Qty.
45068	45830	3"	9/16"	50
45069	45832	6"	9/16"	30



Magnetic Nut Setters

1/4" Hex Drive Magnetic Nut Setters



1/4"



CHROME VANADIUM STEEL

• Lobular Design

Extra strength magnet secured in place with splined brass bushing.

Bulk

Product	Length	Size	Box/Case
45060	1-5/8"	1/4"	10 / 50
45062	1-5/8"	5/16"	10 / 50
45064	1-7/8"	3/8"	10 / 50
45066	1-7/8"	7/16"	10 / 50
45067	1-7/8"	1/2"	10 / 50

Carded - One per card

Product	Length	Size	Box/Case
44636	1-5/8"	1/4"	5 / 50
44638	1-5/8"	5/16"	5 / 50
44640	1-7/8"	3/8"	5 / 50
44642	1-7/8"	7/16"	5 / 50
44644	1-7/8"	1/2"	5 / 50



JAR Magnetic Nut Setter Jars

Product	Contains Bit #	Length	Size	Qty.
45080	45060	1-5/8"	1/4"	50
45082	45062	1-5/8"	5/16"	50
45084	45064	1-7/8"	3/8"	50
45086	45066	1-7/8"	7/16"	50
45950	45067	1-7/8"	1/2"	50



1/4"

CHROME VANADIUM STEEL

• Lobular Design

Bulk

Product	Length	Size	Box/Case
45480	2-9/16"	1/4"	10 / 50
45482	2-9/16"	5/16"	10 / 50
45484	2-9/16"	3/8"	10 / 50
45486	2-9/16"	7/16"	10 / 50
45487	2-9/16"	1/2"	10 / 50
45488	2-9/16"	9/16"	10 / 50

Carded - One per card

Product	Length	Size	Box/Case
44648	2-9/16"	1/4"	5 / 50
44650	2-9/16"	5/16"	5 / 50
44652	2-9/16"	3/8"	5 / 50
44654	2-9/16"	7/16"	5 / 50
44656	2-9/16"	1/2"	5 / 50
44658	2-9/16"	9/16"	5 / 50



JAR Magnetic Nut Setter Jars

Product	Contains Bit #	Length	Size	Qty.
45952	45480	2-9/16"	1/4"	50
45953	45482	2-9/16"	5/16"	50
45954	45484	2-9/16"	3/8"	50
45955	45486	2-9/16"	7/16"	50
45956	45487	2-9/16"	1/2"	50
45957	45488	2-9/16"	9/16"	40



1/4" Hex Drive Magnetic Nut Setters (con't.)

CHROME VANADIUM STEEL



1/4"

• Lobular Design

Bulk

Product	Length	Size	Box/Case
45490	6"	1/4"	5 / 50
45492	6"	5/16"	5 / 50
45494	6"	3/8"	5 / 50

Carded - One per card

Product	Length	Size	Box/Case
44660	6"	1/4"	5 / 25
44662	6"	5/16"	5 / 25
44664	6"	3/8"	5 / 25



5 Pc. Magnetic Nut Setter Sets



CHROME VANADIUM STEEL



1/4"

Quick-Change Power Shank

The Importance of Lobular Geometry

Our lobular design reduces the stripping of the corners of the nut. Fasteners are driven on their flat sides instead of their corners.

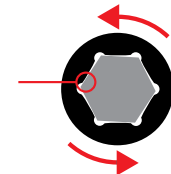

Extra Strength Magnet

An extra strength magnet results in greater retention of your fastener. Fewer dropped fasteners make your job faster and easier.



Carded

Product	Contains	Box/Case
46009	5 Pc. Magnetic Nut Setter Set - Contains: 1/4" x 1-5/8", 5/16" x 1-5/8", 3/8" x 1-7/8", 5/16" x 1-7/8", 1/2" x 1-7/8" Magnetic Nut Setters and 3" Magnetic Guide Driver	6 / 24
46010	5 Pc. Magnetic Nut Setter Set - Length 2-9/16" Contains: 1/4", 5/16", 3/8", 5/16", 1/2" Magnetic Nut Setters and 3" Magnetic Guide Driver	6 / 24

■ Tapered 1/4" Hex Magnetic Nut Setter



- 1/4" Power Hex Shank.
- For driving 1/4" hex nuts in tight spaces.
- Popular for windows and mobile homes.

Bulk

Product	Length	Shank	Box/Case
45525	2"	1/4"	10 / 50

Carded - One per card

Product	Length	Shank	Box/Case
44706	2"	1/4"	5 / 50



■ SDS® Nut Setters

- Lobular design reduces stripping.
- Extra strength magnet results in greater retention of your fastener.



- Rockwell Hardness 60 - 64.



Carded - One per card

Product	Length	Size	Box/Case
44790	2-1/2"	1/4"	5 / 25
44792	2-1/2"	5/16"	5 / 25
44794	2-1/2"	3/8"	5 / 25
44796	2-1/2"	7/16"	5 / 25
44798	2-1/2"	1/2"	5 / 25



■ Non-Magnetic Spring Nut Setters



Specially designed for stainless steel hex head screws and nuts. Ball bearing and spring action hold nut securely in place.

Bulk

Product	Size	Shank	Box/Case
45515	1/4 x 1-3/4"	1/4"	10 / 50
45516	5/16 x 1-3/4"	1/4"	10 / 50
45517	3/8 x 1-3/4"	1/4"	10 / 50

Carded - One per card

Product	Size	Shank	Box/Case
44694	1/4 x 1-3/4"	1/4"	5 / 50
44696	5/16 x 1-3/4"	1/4"	5 / 50
44698	3/8 x 1-3/4"	1/4"	5 / 50



■ Hex to Square Socket Adapters



Bulk

Product	Length	Size	Box/Case
45534	2-1/2"	1/4" Hex - 1/4" Sq.	10 / 100
45548	2-1/2"	1/4" Hex - 3/8" Sq.	10 / 100
45554	3"	1/4" Hex - 1/2" Sq.	10 / 100

Carded - One per card

Product	Length	Size	Box/Case
44732	2-1/2"	1/4" Hex - 1/4" Sq.	5 / 50
44734	2-1/2"	1/4" Hex - 3/8" Sq.	5 / 50
44736	3"	1/4" Hex - 1/2" Sq.	5 / 50



■ Square Socket Adapter Jars

Product	Contains #	Size	Jar Qty.
45973	45534	1/4" Hex - 1/4" Sq.	50
45974	45548	1/4" Hex - 3/8" Sq.	50
45975	45554	1/4" Hex - 1/2" Sq.	50



■ SDS® to Square Socket Adapters



Carded - One per card

Product	Length	Size	Box/Case
44780	3"	SDS to 3/8" SQ	5 / 25
44782	3"	SDS to 1/2" SQ	5 / 25



■ Ceiling Tile Hanger Driver



Bulk

Product	Length	Size	Shank	Box/Case
45056	2-5/8"	9/16"	1/4"	10 / 100

Carded - One per card

Product	Length	Size	Shank	Box/Case
44720	2-5/8"	9/16"	1/4"	5 / 50



■ Hanger Bolt Drivers



- 1/4" Power Hex Shank.
- For driving hanger bolts and threaded rod.

Bulk

Product	Length	Thread Size	Shank	Box/Case
45510	1-5/8"	1/4" - 20	1/4"	10 / 50
45511	1-5/8"	5/16" - 18	1/4"	10 / 50
45512	1-7/8"	3/8" - 16	1/4"	10 / 50

Carded - One per card

Product	Length	Thread Size	Shank	Box/Case
44688	1-5/8"	1/4" - 20	1/4"	5 / 50
44690	1-5/8"	5/16" - 18	1/4"	5 / 50
44692	1-7/8"	3/8" - 16	1/4"	5 / 50





Specialty Drivers & Screwdriving Sets

■ Slotted Sidewalk Driver -

For hurricane shutters



Bulk Product	Length	Size	Shank	Box/Case
45632	3-3/4"	9/16"	1/4"	10 / 100

Carded Product	Length	Size	Shank	Box/Case
44712	3-3/4"	9/16"	1/4"	5 / 50

■ Wing Nut Driver -

For hurricane shutters



Bulk Product	Length	Size	Shank	Box/Case
45630	2-1/2"	1/4" - 20 Wing Nuts	1/4"	10 / 100

Carded Product	Length	Size	Shank	Box/Case
44710	2-1/2"	1/4" - 20 Wing Nuts	1/4"	5 / 50

■ 3/16" Nut Setter for Panelmate® Screws - For hurricane shutters



CHROME VANADIUM STEEL

Bulk Product	Size	Shank	Box/Case
45629	2" x 3/16"	1/4"	10/100

Carded Product	Size	Shank	Box/Case
44708	2" x 3/16"	1/4"	5 / 50

The advantages of IVY Classic® Screwdriving Sets:

- Only IVY Classic® Screwdriving Sets contain the **Mega-Magnetic® Bit Holder** with its unique two magnet design.



- Innovative **hinged bit holder trays** flip up for VERY easy access and removal of bits.
- Trays can **snap lock at 45°** or pivot to any desired angle.
- Trays are **also removable**.
- Bright **color coded insert cards** for quick bit identification.

Sets are carded with full content information on back.



D IHS - Screwdriving & Magnetic Nut Setter Display



Product	Description	Qty.
46000	42 Pc. All Purpose Screwdriving Set	1
46001	41 Pc. Contractor Screwdriving Set	1
46002	42 Pc. Tamper Resistant Screwdriving Set	1
46003	23 Pc. Long Power Bit Screwdriving Set	1
46009	5 Pc. Magnetic Nut Setter - Length 1-5/8 - 1-7/8"	1
46010	5 Pc. Magnetic Nut Setter - Length 2-9/16"	1

Size: 20"W, 31"H

31 Pc. MegaMAGNETIC® DRIVER SET



Patented in the USA



See page 91 for details.

Prod.	Description	Box/Case
60085	31 Pc. Mega-Magnetic Driver Set	1 / 5





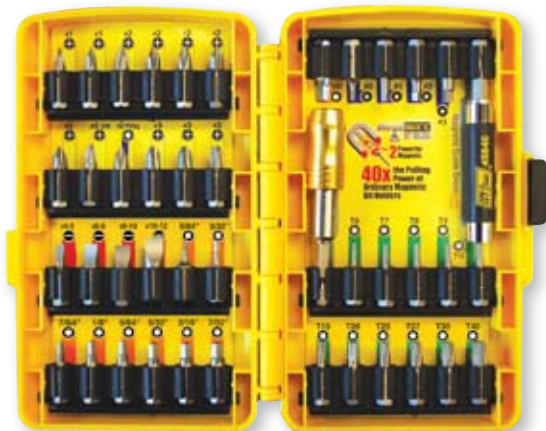

Panelmate® is a registered trademark of Acument Global Technologies.

S2 Tool Steel bits have
Rockwell Hardness 60-64.

Screwdriving Sets





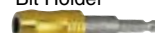

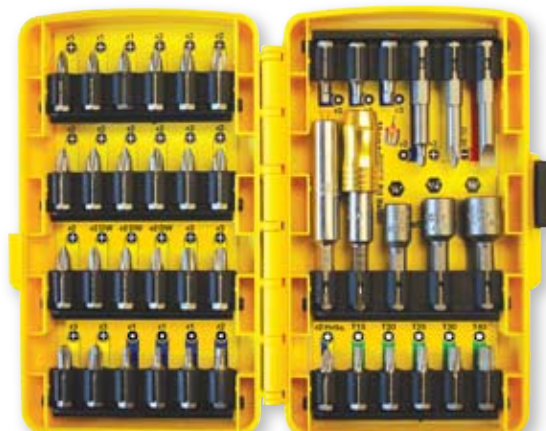

MegaMAGNETIC® ■ 42 Pc. All Purpose



- | | | | |
|--|---|---|---|
| <p> Phillips®:</p> <ul style="list-style-type: none"> 2 45000 - #1 5 45002 - #2 3 45004 - #3 1 45006 - DW #2 <p> Phillips/Square:</p> <ul style="list-style-type: none"> 1 45809 - #2 <p> Square:</p> <ul style="list-style-type: none"> 1 45170 - #0 1 45034 - #1 1 45036 - #2 1 45176 - #3 | <p> Slotted:</p> <ul style="list-style-type: none"> 1 45019 - #4-5 1 45020 - #6-8 1 45022 - #8-10 1 45024 - #10-12 <p> Hex:</p> <ul style="list-style-type: none"> 1 45354 - 5/64" 1 45356 - 3/32" 1 45358 - 7/64" 1 45360 - 1/8" 1 45361 - 9/64" 1 45362 - 5/32" 1 45364 - 3/16" 1 45366 - 7/32" 1 45368 - 1/4" | <p> Torx®:</p> <ul style="list-style-type: none"> 1 45290 - T6 1 45292 - T7 1 45294 - T8 1 45296 - T9 1 45298 - T10 1 45300 - T15 1 45302 - T20 1 45304 - T25 1 45306 - T27 1 45308 - T30 1 45310 - T40 | <p>Magnetic Screw Guide Driver</p> <p></p> <ul style="list-style-type: none"> 1 45840 - 3" <p>Mega-Magnetic® Bit Holder</p> <p></p> <ul style="list-style-type: none"> 1 45834 - 3" |
|--|---|---|---|
- Carded Product** Box/Case
46000 5 / 20











MegaMAGNETIC® ■ 41 Pc. Contractor



- | | | | |
|---|---|--|--|
| <p> Phillips®:</p> <ul style="list-style-type: none"> 3 45000 - 1" #1 10 45002 - 1" #2 4 45004 - 1" #3 3 45006 - 1" DW #2 1 45010 - 2" #2 <p> Slotted:</p> <ul style="list-style-type: none"> 1 45250 - 2" #8-10 <p> Square:</p> <ul style="list-style-type: none"> 3 45034 - 1" #1 3 45036 - 1" #2 1 45176 - 1" #3 1 45200 - 2" #2 | <p> Phillips/Square:</p> <ul style="list-style-type: none"> 1 45809 - 1" #2 <p> Torx®:</p> <ul style="list-style-type: none"> 1 45300 - T15 1 45302 - T20 1 45304 - T25 1 45308 - T30 1 45310 - T40 | <p>1/4" Hex Drive Magnetic Nut Setters</p> <p></p> <ul style="list-style-type: none"> 1 45060 - 1/4" x 1 5/8" 1 45062 - 5/16" x 1 5/8" 1 45064 - 3/8" x 1 7/8" | <p>Mega-Magnetic® Bit Holder</p> <p></p> <ul style="list-style-type: none"> 1 45834 - 3" <p>3" Magnetic Bit Holder</p> <p></p> <ul style="list-style-type: none"> 1 45050 - 3" |
|---|---|--|--|
- Carded Product** Box/Case
46001 5 / 20







MegaMAGNETIC® ■ 42 Pc. Tamper Resistant



- | | | | |
|---|--|---|--|
| <p> ACR Phillips®:</p> <ul style="list-style-type: none"> 2 45700 - #1 4 45702 - #2 1 45703 - Red. #2 1 45704 - #3 <p> Slotted ACR:</p> <ul style="list-style-type: none"> 1 45742 - #6-8 1 45744 - #8-10 1 45746 - #10-12 <p> Pozidriv:</p> <ul style="list-style-type: none"> 1 45780 - #0 1 45782 - #1 1 45784 - #2 1 45786 - #3 | <p> Phillips®/Square:</p> <ul style="list-style-type: none"> 1 45809 - #2 <p> Tri-Wing:</p> <ul style="list-style-type: none"> 1 45422 - #1 1 45424 - #2 1 45426 - #3 <p> Spanner:</p> <ul style="list-style-type: none"> 1 45386 - #6 1 45388 - #8 1 45390 - #10 1 45392 - #12 | <p> Hex Tamper:</p> <ul style="list-style-type: none"> 1 45432 - 3/32" 1 45434 - 1/8" 1 45436 - 9/64" 1 45438 - 5/32" 1 45440 - 3/16" 1 45442 - 7/32" 1 45444 - 1/4" 1 45446 - 5/16" <p>Mega-Magnetic®</p> <p></p> <ul style="list-style-type: none"> 1 45834 - 3" | <p> Torx® Tamper:</p> <ul style="list-style-type: none"> 1 45400 - TT8 1 45402 - TT9 1 45404 - TT10 1 45406 - TT15 1 45408 - TT20 1 45410 - TT25 1 45412 - TT27 1 45414 - TT30 1 45416 - TT40 <p>3" Quick Release</p> <p></p> <ul style="list-style-type: none"> 1 45830 - 3" |
|---|--|---|--|
- Carded Product** Box/Case
46002 5 / 20

Rapid Reload® ■ 23 Pc. Long Power Bit



- | | | | |
|---|--|--|--|
| <p> Phillips®:</p> <ul style="list-style-type: none"> 1 45008 - #1 1 45010 - #2 1 45012 - #3 <p>2-3/4" Phillips®:</p> <ul style="list-style-type: none"> 1 45124 - #1 1 45014 - #2 1 45156 - #3 <p> Phillips/Square:</p> <ul style="list-style-type: none"> 1 45810 - #2 <p>2-1/2" Hex to Square Socket Adapter</p> <p></p> <ul style="list-style-type: none"> 1 45534 - 1/4" - 1/4" 1 45548 - 1/4" - 3/8" | <p> Slotted:</p> <ul style="list-style-type: none"> 1 45250 - #8-10 <p> Square:</p> <ul style="list-style-type: none"> 1 45182 - #1 1 45200 - #2 1 45220 - #3 <p>2-3/4" Square:</p> <ul style="list-style-type: none"> 1 45184 - #1 1 45202 - #2 1 45222 - #3 | <p> Torx®:</p> <ul style="list-style-type: none"> 1 45316 - T10 1 45318 - T15 1 45320 - T20 1 45322 - T25 1 45326 - T30 1 45328 - T40 | <p>1/4" Hex Rapid Reload® Power Bit Holder</p> <p></p> <ul style="list-style-type: none"> 1 45636 - 2-3/8" |
|---|--|--|--|
- Carded Product** Box/Case
46003 5 / 20



Bit Displays

IHD1 contains our best selling combination of carded insert bits and holders.

IHD2 through IHD8 contain all our carded insert bits and holders with no duplication.*

Carded Insert Bit and Holder Displays

Headers are clear and organized with space for retail prices. Barcodes for easy reordering.

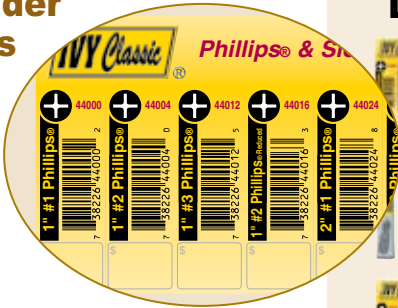

Snap-lock box labels are coordinated for quick & easy identification.



Snap-lock boxes are individually barcoded and provide perfect storage for bits.

Each 12" rack holds 16 snap lock boxes.

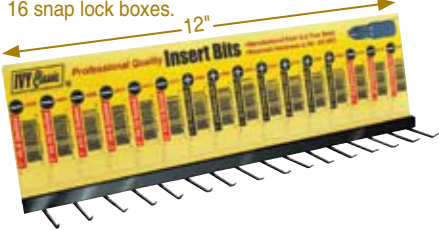

Purchase a ready-made display!

or

Customize a display!

Select 16 carded bit packs of your choice and receive a header with labels to arrange as you like.

IHD9 - Custom Carded Display



Add 16 labels

IHD1 - Display

Top Sellers

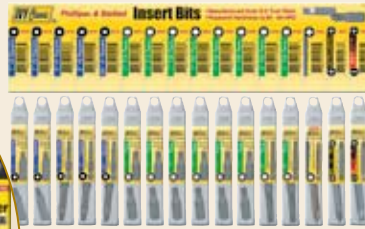

Size: 12"W, 21"H

Prod.	Description	Card Qty.	D Qty.
44000	1" #1 Phillips	2	10
44004	1" #2 Phillips	2	10
44012	1" #3 Phillips	2	10
44016	1" #2 Phillips Red.	2	10
44024	2" #1 Phillips	1	10
44028	2" #2 Phillips	1	10
44034	2" #3 Phillips	1	10
44040	2 3/4" #2 Phillips	1	10
44042	2 3/4" #3 Phillips	1	10
44046	3 1/2" #2 Phillips	1	10
44202	1" #6-8 Slotted	1	10
44212	2" #8-10 Slotted	1	10
44068	1" #2 Phillips ACR	1	10
44082	2" #2 Phillips ACR	1	10
44104	1" #1 Square	1	10
44108	1" #2 Square	2	10
44118	1" #3 Square	1	10
44136	2" #1 Sq. Power	1	10
44140	2" #2 Sq. Power	1	10
44152	2 3/4" #2 Sq. Power	1	10
44314	1" T10 Torx	1	10
44316	1" T15 Torx	1	10
44318	1" T20 Torx	1	10
44320	1" T25 Torx	1	10
44324	1" T27 Torx	1	10
44326	1" T30 Torx	1	10
44348	2" T20 Torx Power	1	10
44350	2" T25 Torx Power	1	10
44352	2" T27 Torx Power	1	10
44258	2" #2 Ph. x #2 Ph. Dbl.	1	10
44260	2" #1 Ph. x #5-6 Sl. Dbl.	1	10
44262	2" #2 Ph. x #6-8 Sl. Dbl.	1	10
44628	3" Mega-Mag. Bit Holder	1	5
44604	3" Mag. Bit Holder	1	5
44620	3" Mag. Guide Driver	1	5
44636	1/4"x1 5/8" Mag. Nut Setter	1	5
44638	5/16"x1 5/8" Mag. Nut Setter	1	5
44640	3/8"x1 7/8" Mag. Nut Setter	1	5

IHD2 - Phillips® & Slotted Display

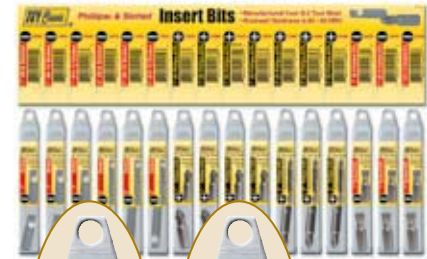

Size: 12"W, 16"H

Prod.	Description	Card Qty.	D Qty.
44000	1" #1 Phillips	2	10
44004	1" #2 Phillips	2	10
44006	1" #2 Phillips	6	10
44012	1" #3 Phillips	2	10
44016	1" #2 Phillips Red.	2	10
44018	1" #2 Phillips Red.	6	10
44024	2" #1 Phillips	1	10
44028	2" #2 Phillips	1	10
44034	2" #3 Phillips	1	10
44038	2 3/4" #1 Phillips	1	10
44040	2 3/4" #2 Phillips	1	10
44042	2 3/4" #3 Phillips	1	10
44044	3 1/2" #1 Phillips	1	10
44046	3 1/2" #2 Phillips	1	10
44048	3 1/2" #3 Phillips	1	10
44200	1" #4-5 Slotted	1	10
44202	1" #6-8 Slotted	1	10
44204	1" #8-10 Slotted	1	10
44206	1" #10-12 Slotted	1	10
44210	2" #6-8 Slotted	1	10
44212	2" #8-10 Slotted	1	10
44214	2" #10-12 Slotted	1	10
44066	1" #1 Phillips ACR	1	10
44068	1" #2 Phillips ACR	1	10
44072	1" #2 Phillips ACR Red.	1	10
44076	1" #3 Phillips ACR	1	10
44078	2" #1 Phillips ACR	1	10
44082	2" #2 Phillips ACR	1	10
44086	2" #3 Phillips ACR	1	10
44238	1" #6-8 Slotted ACR	1	10
44240	1" #8-10 Slotted ACR	1	10
44242	1" #10-12 Slotted ACR	1	10
44052	4" #2 Phillips	1	5
44056	6" #2 Phillips	1	5
44022	1" #2 Ph. Drywall Setter	1	10

Carded Insert Bit and Holder Displays



IHD3 - Square & Torx® Display



Size:
12"W,
16"H

Prod.	Description	Card Qty.	D Qty.
44100	1" #0 Square	1	10
44104	1" #1 Square	1	10
44108	1" #2 Square	2	10
44110	1" #2 Square	6	10
44118	1" #3 Square	1	10
44136	2" #1 Sq. Power	1	10
44140	2" #2 Sq. Power	1	10
44146	2" #3 Sq. Power	1	10
44150	2 3/4" #1 Sq. Power	1	10
44152	2 3/4" #2 Sq. Power	1	10
44154	2 3/4" #3 Sq. Power	1	10
44306	1" T6 Torx	1	10
44308	1" T7 Torx	1	10
44310	1" T8 Torx	1	10
44312	1" T9 Torx	1	10
44314	1" T10 Torx	1	10
44316	1" T15 Torx	1	10
44318	1" T20 Torx	1	10
44320	1" T25 Torx	1	10
44322	1" T25 Torx	6	10
44324	1" T27 Torx	1	10
44326	1" T30 Torx	1	10
44328	1" T40 Torx	1	10
44344	2" T10 Torx Power	1	10
44346	2" T15 Torx Power	1	10
44348	2" T20 Torx Power	1	10
44350	2" T25 Torx Power	1	10
44352	2" T27 Torx Power	1	10
44354	2" T30 Torx Power	1	10
44356	2" T40 Torx Power	1	10
44250	1" Ph. Sq. Driv	1	10
44252	2" Ph. Sq. Driv	1	10
44164	6" #2 Square	1	5
44116	1" #2 Sq. Dr. Setter	1	10

IHD4 - Tamper Resistant Display



Size:
12"W,
16"H

One
insert bit
per card

Prod.	Description	D Qty.
44306	1" T6 Torx	10
44308	1" T7 Torx	10
44378	1" T8 Torx Tamper	10
44380	1" T9 Torx Tamper	10
44382	1" T10 Torx Tamper	10
44384	1" T15 Torx Tamper	10
44386	1" T20 Torx Tamper	10
44388	1" T25 Torx Tamper	10
44390	1" T27 Torx Tamper	10
44392	1" T30 Torx Tamper	10
44394	1" T40 Torx Tamper	10
44458	1" 3/32" Hex Tamper	10
44460	1" 1/8" Hex Tamper	10
44462	1" 9/64" Hex Tamper	10
44464	1" 5/32" Hex Tamper	10
44466	1" 3/16" Hex Tamper	10
44468	1" 7/32" Hex Tamper	10
44470	1" 1/4" Hex Tamper	10
44472	1" 5/16" Hex Tamper	10
44502	1" #6 Spanner	10
44504	1" #8 Spanner	10
44506	1" #10 Spanner	10
44508	1" #12 Spanner	10
44520	1" #1 Tri-Wing	10
44522	1" #2 Tri-Wing	10
44524	1" #3 Tri-Wing	10
44526	1" #4 Tri-Wing	10
44528	1" #5 Tri-Wing	10
44512	1" #0 Pozidriv	10
44514	1" #1 Pozidriv	10
44516	1" #2 Pozidriv	10
44518	1" #3 Pozidriv	10

IHD5 - Hex & Double-End Display

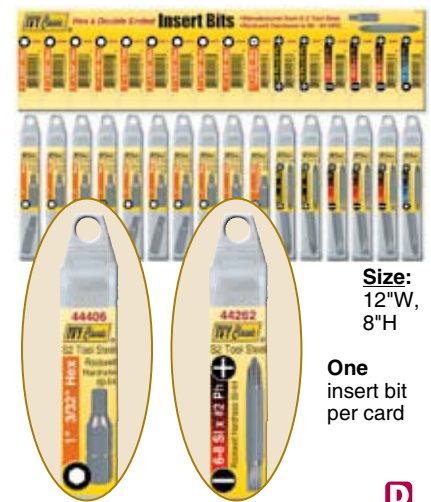

Size:
12"W,
8"H

One
insert bit
per card

Prod.	Description	D Qty.
44404	1" 5/64" Hex	10
44406	1" 3/32" Hex	10
44408	1" 7/64" Hex	10
44410	1" 1/8" Hex	10
44412	1" 9/64" Hex	10
44414	1" 5/32" Hex	10
44416	1" 3/16" Hex	10
44418	1" 7/32" Hex	10
44420	1" 1/4" Hex	10
44472	1" 5/16" Hex Tamper	10
44256	2" #1 Ph. x #2 Ph.	10
44258	2" #2 Ph. x #2 Ph.	10
44260	2" #1 Ph. x #5-6 Sl.	10
44262	2" #2 Ph. x #6-8 Sl.	10
44264	2" #3 Ph. x #8-10 Sl.	10
44266	2" #2 Ph. x #2 Sq.	10

IHD6 SDS® Nut Setters and Holders Display



Size: 7"W, 14"H

Prod.	Description	D Qty.
44775	3" SDS Mega-Magnetic® Holder	5
44790	1/4" x 2 1/2" SDS Mag. Nut Setter	5
44792	5/16" x 2 1/2" SDS Mag. Nut Setter	5
44794	3/8" x 2 1/2" SDS Mag. Nut Setter	5
44796	7/16" x 2 1/2" SDS Mag. Nut Setter	5
44798	1/2" x 2 1/2" SDS Mag. Nut Setter	5
44780	3" SDS to 3/8" SQ Adapter	5
44782	3" SDS to 1/2" SQ Adapter	5

* 1" - T6, T7 and 5/16" Hex Tamper are contained in two displays.



Insert Bit and Holder Displays

IDC1 contains our best selling combination of insert bits and holders.

D IHD7 - Magnetic Nut Setter Display



Size: 17"W, 13"H

Prod.	Dia	Length	Description	Qty.
44636	1/4"	1-5/8"	Mag. Nut Set.	5
44706	1/4"	2" Tapered	Mag. Nut Set.	5
44638	5/16"	1-5/8"	Mag. Nut Set.	5
44640	3/8"	1-7/8"	Mag. Nut Set.	5
44642	7/16"	1-7/8"	Mag. Nut Set.	5
44644	1/2"	1-7/8"	Mag. Nut Set.	5
44648	1/4"	2-9/16"	Mag. Nut Set.	5
44650	5/16"	2-9/16"	Mag. Nut Set.	5
44652	3/8"	2-9/16"	Mag. Nut Set.	5
44654	7/16"	2-9/16"	Mag. Nut Set.	5
44656	1/2"	2-9/16"	Mag. Nut Set.	5
44658	9/16"	2-9/16"	Mag. Nut Set.	5
44660	1/4"	6"	Mag. Nut Set.	5
44662	5/16"	6"	Mag. Nut Set.	5
44664	3/8"	6"	Mag. Nut Set.	5

D IHD8 - Magnetic Holders, Drivers & Adapters



Size: 15"W, 14"H

Prod.	Description	Qty.
44604	3" Magnetic Bit Holder	5
44600	2 3/8" Magnetic Bit Holder	5
44608	6" Magnetic Bit Holder	5
44620	3" Mag. Screw Guide Driver	5
44622	5" Mag. Screw Guide Driver	5
44614	3" Mag. Quick Release	5
44616	6" Mag. Quick Release	5
45638	2 3/8" Rapid Reload® Power	5
45640	6" Rapid Reload® Power	5
44732	2 1/2" Adapter 1/4 Hex - 1/4" SQ	5
44734	2 1/2" Adapter 1/4 Hex - 3/8" SQ	5
44736	3" Adapter 1/4 Hex - 1/2" SQ	5
44720	2 5/8" Ceiling Tile Hanger Driver	5

More selling power in a smaller space!

Our bulk insert bits and holders are available in hex jar displays.



Size: 14"W, 18"H, 13"D

D CJH1 - Hex Jar Display

Prod.	Size	Qty.
Phillips Bits		
45002	1" #2	500
45010	2" #2	100
Screw Setter		
45058	1" #2	20
Square Bit		
45036	1" #2	100
45200	2" #2	50
Mag. Bit Holder		
45050	3"	20
Mag. Nut Setters		
45060	1/4" x 1 5/8"	20
45062	5/16" x 1 5/8"	20
45064	3/8" x 1 7/8"	20
Mag. Screw Guide		
45840	3"	10
45842	5"	10
Mag. Quick Release		
45830	3"	10

D CJH2 - Hex Jar Display

Prod.	Size	Qty.
Phillips Bits		
45000	1" #1	200
45004	1" #3	200
45006	1" #2 Red.	300
45702	1" #2 ACR	300
Mag. Quick Release		
45832	6"	5
Mag. Bit Holder		
45052	2-3/8"	20
Rapid Reload® Holder		
45636	2-3/8"	10
Mag. Nut Setters		
45066	7/16" x 1 7/8"	10
45067	1/2" x 1 7/8"	10
45480	1/4" x 2-9/16"	20
45482	5/16" x 2-9/16"	20
45484	3/8" x 2-9/16"	20

D CJH3 - Custom Hex Jar Display

- You can now create your own hex jar display.
- Receive a FREE hex jar rack with the purchase of any 12 jar combination.

D IDC1 - Cabinet



Prod.	Description	Qty.
Phillips Bits		
45000	1" #1 Phillips	100
45002	1" #2 Phillips	100
45004	1" #3 Phillips	100
45006	1" #2 Phillips Red.	100
Phillips Drivers		
45008	2" #1 Phillips	50
45010	2" #2 Phillips	50
45012	2" #3 Phillips	50
45014	2 3/4" #2 Phillips	50
45156	2 3/4" #3 Phillips	50
45016	3 1/2" #2 Phillips	25
Slotted Bits		
45020	1" #6-8 Slotted	50
45250	2" #8-10 Slotted	25
Phillips ACR Bits		
45702	1" #2 Ph ACR	100
45703	1" #2 Ph ACR Red.	100
45708	2" #2 Ph ACR	50
Square Bits		
45034	1" #1 Square	50
45036	1" #2 Square	50
45176	1" #3 Square	50
Square Drivers		
45182	2" #1 Sq. Power	25
45200	2" #2 Sq. Power	25
45202	2 3/4" #2 Sq. Power	25
Torx Bits		
45298	1" T10 Torx	25
45300	1" T15 Torx	25
45302	1" T20 Torx	25
45304	1" T25 Torx	25
45306	1" T27 Torx	25
45308	1" T30 Torx	25
Torx Power Bits		
45320	2" T20 Torx Power	25
45322	2" T25 Torx Power	25
45324	2" T27 Torx Power	25
Phillips x Phillips		
45277	2" #2 Ph. x #2 Ph.	25
Mag. Bit Holder		
45050	3" Mag. Bit Holder	10
Mag. Guide Driver		
45840	3" Mag. Guide Driver	10
Mag. Nut Setters		
45060	1/4"x1 5/8" Mag. Nut Set.	10
45062	5/16"x1 5/8" Mag. Nut Set.	10
45064	3/8"x1 7/8" Mag. Nut Set.	10

IDC2 through IDC6 contain all our insert bits and holders with no duplication.

Insert Bit and Holder Cabinets



IDC2 - Cabinet



Prod.	Description	Qty.
45000	1" #1 Phillips	100
45002	1" #2 Phillips	100
45004	1" #3 Phillips	100
45006	1" #2 Phillips Red.	100
45008	2" #1 Phillips	50
45010	2" #2 Phillips	50
45012	2" #3 Phillips	50
45124	2 3/4" #1 Phillips	50
45014	2 3/4" #2 Phillips	50
45156	2 3/4" #3 Phillips	50
45126	3 1/2" #1 Phillips	25
45016	3 1/2" #2 Phillips	25
45158	3 1/2" #3 Phillips	25
45144	4" #2 Phillips	10
45148	6" #2 Phillips	10
45019	1" #4-5 Slotted	50
45020	1" #6-8 Slotted	50
45022	1" #8-10 Slotted	50
45024	1" #10-12 Slotted	50
45248	2" #6-8 Slotted	25
45250	2" #8-10 Slotted	25
45260	2" #10-12 Slotted	25
45700	1" #1 Phillips ACR	100
45702	1" #2 Phillips ACR	100
45703	1" #2 Phillips ACR Red.	100
45704	1" #3 Phillips ACR	100
45706	2" #1 Phillips ACR	50
45708	2" #2 Phillips ACR	50
45710	2" #3 Phillips ACR	50
45742	1" #6 - 8 Slotted ACR	50
45744	1" #8 - 10 Slotted ACR	50
45746	1" #10 - 12 Slotted ACR	50
45058	1" #2 Ph. Drywall Setter	20

IDC3 - Cabinet



Prod.	Description	Qty.
45170	1" #0 Square	50
45034	1" #1 Square	50
45036	1" #2 Square	50
45176	1" #3 Square	50
45182	2" #1 Sq. Power	25
45200	2" #2 Sq. Power	25
45220	2" #3 Sq. Power	25
45184	2 3/4" #1 Sq. Power	25
45202	2 3/4" #2 Sq. Power	25
45222	2 3/4" #3 Sq. Power	25
45232	6" #2 Sq. Power	10
45175	1" #2 Sq. Dr. Setter	20
45809	1" Phil. Sq. Driv	50
45810	2" Phil. Sq. Driv	25
45290	1" T6 Torx	25
45292	1" T7 Torx	25
45294	1" T8 Torx	25
45296	1" T9 Torx	25
45298	1" T10 Torx	25
45300	1" T15 Torx	25
45302	1" T20 Torx	25
45304	1" T25 Torx	25
45306	1" T27 Torx	25
45308	1" T30 Torx	25
45310	1" T40 Torx	25
45316	2" T10 Torx Power	25
45318	2" T15 Torx Power	25
45320	2" T20 Torx Power	25
45322	2" T25 Torx Power	25
45324	2" T27 Torx Power	25
45326	2" T30 Torx Power	25
45328	2" T40 Torx Power	25

IDC4 - Cabinet



Prod.	Description	Qty.
45400	1" T8 Torx Tamper	10
45402	1" T9 Torx Tamper	10
45404	1" T10 Torx Tamper	10
45406	1" T15 Torx Tamper	10
45408	1" T20 Torx Tamper	10
45410	1" T25 Torx Tamper	10
45412	1" T27 Torx Tamper	10
45414	1" T30 Torx Tamper	10
45416	1" T40 Torx Tamper	10
45354	1" 5/64" Hex	10
45356	1" 3/32" Hex	10
45358	1" 7/64" Hex	10
45360	1" 1/8" Hex	10
45361	1" 9/64" Hex	10
45362	1" 5/32" Hex	10
45364	1" 3/16" Hex	10
45366	1" 7/32" Hex	10
45368	1" 1/4" Hex	10
45432	1" 3/32" Hex Tamper	10
45434	1" 1/8" Hex Tamper	10
45436	1" 9/64" Hex Tamper	10
45438	1" 5/32" Hex Tamper	10
45440	1" 3/16" Hex Tamper	10
45442	1" 7/32" Hex Tamper	10
45444	1" 1/4" Hex Tamper	10
45446	1" 5/16" Hex Tamper	10
45386	1" #6 Spanner	10
45388	1" #8 Spanner	10
45390	1" #10 Spanner	10
45392	1" #12 Spanner	10
45422	1" #1 Tri-Wing	10
45424	1" #2 Tri-Wing	10
45426	1" #3 Tri-Wing	10
45427	1" #4 Tri-Wing	10
45428	1" #5 Tri-Wing	10
45780	1" #0 Pozidriv	10
45782	1" #1 Pozidriv	10
45784	1" #2 Pozidriv	10
45786	1" #3 Pozidriv	10

IDC5 - Cabinet



Prod.	Description	Qty.
45060	1/4"x1 3/8" Mag. Nut Set.	10
45062	5/16"x1 1/8" Mag. Nut Set.	10
45064	3/8"x1 1/8" Mag. Nut Set.	10
45066	7/16"x1 7/8" Mag. Nut Set.	10
45067	1/2"x1 7/8" Mag. Nut Set.	10
45525	1/4" Tapered Mag. Nut Set. Length 2"	10
45480	1/4" Mag. Nut Setter Length 2-9/16"	10
45482	5/16" Mag. Nut Setter	10
45484	3/8" Mag. Nut Setter	10
45486	7/16" Mag. Nut Setter	10
45487	1/2" Mag. Nut Setter	10
45488	9/16" Mag. Nut Setter	10
45490	1/4" 6" Mag. Nut Setter	5
45492	5/16" 6" Mag. Nut Setter	5
45494	3/8" 6" Mag. Nut Setter	5
45515	1/4" 1 3/4" Non-Mag. Nut Set.	10
45516	5/16" 1 3/4" Non-Mag. Nut Set.	10
45517	3/8" 1 3/4" Non-Mag. Nut Set.	10

IDC6 Cabinet

Prod.	Description	Qty.
45050	3" Mag. Bit Holder	10
45052	2 3/8" Mag. Bit Holder	10
45054	6" Mag. Bit Holder	5
45840	3" Mag. Guide Driver	10
45842	5" Mag. Guide Driver	10
45830	3" Mag. Quick Release	10
45832	6" Mag. Quick Release	5
45636	2 3/8" Rapid Reload Pow.	10
45056	2 5/8" Ceiling Tile Hanger	10
45534	2 1/2" Adapt. 1/4 Hex - 1/4" Sq	10
45548	2 1/2" Adapt. 1/4 Hex - 3/8" Sq	10
45554	3" Adapt. 1/4 Hex - 1/2" Sq	10



Each display includes a free metal cabinet that stacks vertically. Individual Cabinet Size: 18"W, 9"H, 6"D

IDC7 - Custom Cabinet

Order 36 bulk packs of different insert bits and/or holders to receive a FREE cabinet with drawer labels to arrange as you like.



Prod.	Description	Qty.
45275	2" #1 Ph. x #2 Ph.	25
45277	2" #2 Ph. x #2 Ph.	25
45274	2" #1 Ph. x #5-6 Sl.	25
45276	2" #2 Ph. x #6-8 Sl.	25
45284	2" #3 Ph. x #8-10 Sl.	25
45278	2" #2 Ph. x #2 Sq.	25

Prod.	Pg.	Prod.	Pg.	Prod.	Pg.	Prod.	Pg.	Prod.	Pg.	Prod.	Pg.	Prod.	Pg.	Prod.	Pg.	Prod.	Pg.
01004	34	01409	40	01538	40	03007	32	06002	35	10506	36	10846	54	11154	72	15254	78
01005	34	01410	40	01539	40	03008	32	06003	35	10507	36	10848	54	11156	73	15260	78
01006	34	01411	40	01540	40	03009	32	06004	35	10508	36	10850	54	11158	75	15262	78
01007	34	01412	40	01541	40	03010	32	06005	35	10509	36	10852	54	11159	75	15316	78
01008	34	01413	40	01542	40	03011	32	06006	35	10510	36	10854	54	11160	74	15320	78
01009	34	01414	40	01543	40	03012	32	06007	35	10511	36	10856	54	11162	74	15322	78
01010	34	01415	40	01544	40	03013	32	06008	35	10512	36	10858	54	11163	73	15416	78
01011	34	01416	40	01545	40	03014	32	06009	35	10513	36	10860	55	11172	72	15420	78
01012	34	01417	40	01546	40	03015	32	06020	35	10514	36	10862	55	11174	73	15444	79
01013	34	01418	40	01547	40	03016	32	09001	43	10515	36	10864	55	11175	74	15448	79
01014	34	01419	40	01548	40	03017	32	09002	43	10516	36	10866	55	11176	73	15452	79
01015	34	01420	40	01549	40	03018	32	09003	43	10517	36	10868	55	11178	72	15454	80
01016	34	01421	40	01550	40	03019	32	09004	43	10518	36	10870	55	11180	73	15456	80
01017	34	01422	40	01551	40	03020	32	09008	43	10519	36	10872	55	11182	73	15500	83
01018	34	01423	40	01552	40	03021	32	09011	43	10520	36	10874	55	11184	75	15502	83
01019	34	01424	40	01553	40	03022	32	09014	43	10521	36	10876	55	11185	75	15504	82
01020	34	01425	40	01554	40	03023	32	09020	43	10522	36	10878	55	11187	73	15505	82
01021	34	01426	40	01555	40	03024	32	09021	43	10523	36	10884	54	11190	73	15506	82
01022	34	01427	40	01556	40	03025	32	09050	33	10524	36	10886	54	11604	82	15510	82
01023	34	01428	40	01557	40	03026	32	09051	33	10525	36	10888	55	11608	82	15600	78
01024	34	01429	40	01558	40	03027	32	09052	33	10526	36	10892	54	11612	82	15602	78
01025	34	01430	40	01559	40	03028	32	10208	49	10527	36	10894	54	11616	82	15604	78
01026	34	01431	40	01560	40	03029	32	10212	49	10528	36	10896	54	11620	82	15610	78
01027	34	01432	40	01581	41	03030	32	10216	49	10529	36	10900	53	11624	82	15650	80
01028	34	01433	40	01606	41	03031	32	10217	49	10530	36	10902	53	11634	82	15652	80
01029	34	01434	40	01609	41	03032	32	10220	49	10531	36	10904	53	12000	83	15654	80
01030	34	01435	40	01617	41	04004	38	10221	49	10532	36	10908	48	12002	83	15656	80
01031	34	01436	40	01621	41	04005	38	10224	49	10590	37	10910	55	12004	83	15658	80
01032	34	01437	40	01646	41	04006	38	10225	49	10592	37	10916	54	12006	83	15668	79
01036	33	01438	40	01649	41	04007	38	10231	49	10593	37	10918	54	12100	86	15669	79
01040	33	01439	40	01657	41	04008	38	10232	49	10594	37	10920	54	12101	86	15671	80
01044	33	01440	40	01661	41	04009	38	10240	49	10700	46	10922	56	12102	86	15700	80
01048	33	01441	40	01668	41	04010	38	10248	49	10702	46	10928	56	12104	86	15720	80
01052	33	01442	40	01707	41	04011	38	10249	49	10704	46	10930	56	12105	86	16002	118
01056	33	01443	40	01708	41	04012	38	10250	49	10705	46	10932	56	12106	86	16004	118
01060	33	01444	40	01709	41	04013	38	10256	49	10706	46	10934	56	12107	86	16008	118
01064	33	01445	40	01710	41	04014	38	10268	50	10707	46	10936	56	12108	86	16010	85
01104	34	01446	40	01711	41	04015	38	10270	50	10708	46	10938	56	12110	86	16020	85
01105	34	01447	40	01712	41	04016	38	10274	50	10709	46	10940	56	12112	86	16030	85
01106	34	01448	40	01713	41	04017	38	10276	50	10710	46	10959	55	12113	86	16040	85
01107	34	01449	40	01730	41	04018	38	10279	50	10711	46	10962	56	12114	86	16050	85
01108	34	01450	40	01731	41	04019	38	10280	50	10712	46	10964	56	12115	86	16060	85
01109	34	01451	40	01732	41	04020	38	10282	50	10713	46	10965	56	12116	86	16080	85
01110	34	01452	40	01808	33	04021	38	10283	50	10714	46	10966	56	12117	86	16104	85
01111	34	01453	40	01810	33	04022	38	10298	50	10715	46	10967	56	12119	86	16106	85
01112	34	01454	40	01812	33	04023	38	10299	50	10716	46	10970	56	12120	86	16109	85
01113	34	01455	40	01814	33	04024	38	10300	49	10718	46	10973	55	12126	86	16150	85
01114	34	01456	40	01816	33	04025	38	10301	49	10720	46	11005	100	12127	86	16212	85
01115	34	01457	40	01817	33	04026	38	10302	49	10722	46	11006	100	12128	86	16218	85
01116	34	01458	40	01908	45	04027	38	10303	49	10724	46	11008	99	12130	86	16224	85
01117	34	01459	40	01912	45	04028	38	10304	49	10726	46	11014	99	13012	92	16236	85
01118	34	01460	40	01916	45	04029	38	10305	49	10740	47	11015	99	13112	92	16300	85
01119	34	01501	40	01920	45	04030	38	10306	49	10742	47	11018	99	13116	92	17002	91
01120	34	01502	40	01924	45	04031	38	10307	49	10744	47	11019	99	13125	92	17004	91
01121	34	01503	40	01928	45	04032	38	10308	49	10746	47	11024	99	13133	92	17008	91
01122	34	01504	40	01932	45	04104	39	10309	49	10748	47	11025	99	13216	92	17012	91
01123	34	01505	40	01955	45	04105	39	10316	49	10750	47	11036	99	13217	92	17014	91
01124	34	01506	40	02004	36	04106	39	10320	49	10761	47	11037	99	13225	92	17017	91
01125	34	01507	40	02005	36	04107	39	10324	49	10763	47	11042	99	13226	92	17022	91
01126	34	01508	40	02006	36	04108	39	10332	49	10764	47	11043	99	13233	92	17023	91
01127	34	01509	40	02007	36	04109	39	10340	49	10765	47	11046	100	13316	92	17050	118
01128	34	01510	40	02008	36	04110	39	10348	49	10766	47	11047	100	13325	92	17066	90
01129	34	01511	40	02009	36	04111	39	10349	49	10768	47	11050	74	13326	92	17071	90
01130	34	01512	40	02010	36	04112	39	10350	49	10769	47	11051	74	13333	92	17073	90
01131	34	01513	40	02011	36	04113	39	10351	49	10774	47	11052	74	13500	93	17075	90
01132	34	01514	40	02012	36	04114	39	10352	49	10775	47	11054	74	13576	93	17085	90
01308	37	01515	40	02013	36	04115	39	10353	49	10776	47	11060	74	13577	93	17106	90
01312	37	01516	40	02014	36	04116	39	10354	49	10777	47	11061	74	14000	119	17181	88
01316	37	01517	40	02015	36	04117	39	10355	49	10778	47	11091	94	14002	119	17185	88
01320	37	01518	40	02016	36	04118	39	10356	49	10804	53	11092	94	14004	119	17186	88
01324	37	01519	40	02017	36	04119	39	10357	49	10806	53	11099	94	14006	119	17188	88
01350	37	01520	40	02018	36	04120	39	10358	49	10808	53	11100	94	15004	82	17190	88
01351	37	01521	40	02019	36	04121	39	10360	52	10810	53	11101	94	15005	80	17191	88
01352	37	01522	40	02020	36	04122	39	10362	52	10812	53	11102	94	15012	80	17192	88
01353	37	01523	40	02021	36	04123	39	10364	52	10814	53	11104	94	15016	79	17194	88
01354	37	01524	40	02022	36	04124	39	10366	52	10816	53	11105	93	15024	79	17196	88
01355	37	01525	40	02023	36	04125	39	10368	52	10818	53	11106	84				

Prod.	Pg.	Prod.	Pg.	Prod.	Pg.	Prod.	Pg.	Prod.	Pg.	Prod.	Pg.	Prod.	Pg.	Prod.	Pg.	Prod.	Pg.
17265	88	19072	102	24015	115	25061	116	27070	15	28111	13	28534	10	36078	16	37807	23
17285	88	19073	102	24016	115	25063	116	27072	15	28112	13	28536	10	36080	16	37808	23
17286	88	19076	102	24017	115	25065	116	27076	15	28114	13	28538	10	36082	16	37809	23
17287	88	19077	102	24018	115	25067	116	27080	15	28115	13	28540	11	36084	16	37810	23
17288	88	19084	102	24019	115	25068	116	27088	15	28116	14	28541	11	36086	16	37811	23
17289	88	19085	102	24020	116	25069	116	27092	15	28117	14	28543	11	36090	16	37826	31
17290	88	19086	102	24022	116	25072	115	27096	15	28118	14	28544	11	36102	16	37952	23
17292	88	19087	102	24023	116	25073	115	27810	12	28120	14	28545	11	36103	16	37954	23
17330	88	19088	103	24024	117	25080	111	27812	12	28132	13	28555	11	36104	16	37956	23
17331	88	19089	103	24025	117	25082	111	27814	12	28136	13	28556	11	36105	16	37957	23
17332	88	19090	103	24026	112	25100	117	27816	12	28140	13	28557	11	36106	16	37958	23
17333	88	19092	103	24028	112	25106	117	27818	12	28141	13	28568	11	36107	16	38040	21
17334	88	19093	103	24030	108	25120	116	27820	12	28142	13	28570	11	36108	16	38042	21
17335	88	19094	103	24032	108	25122	116	27822	12	28143	13	28571	11	36109	16	38044	21
17336	88	19095	103	24034	108	25220	110	27824	12	28144	13	28573	11	36110	16	38045	21
17400	88	19100	104	24036	109	25221	110	27826	12	28150	13	28574	11	36112	16	38046	21
17401	88	19101	104	24037	109	25222	110	27828	12	28200	10	28575	11	36116	16	38047	21
17405	88	19120	105	24038	109	25223	110	27830	12	28202	10	28587	11	36118	16	38050	21
17410	88	19123	106	24039	109	25224	110	27832	12	28204	10	28588	11	36120	16	38052	21
18106	95	19124	106	24040	115	25225	110	27834	12	28206	10	28589	11	36122	16	38054	21
18108	95	19125	106	24041	115	26000	107	27836	12	28208	10	28598	11	36170	17	38055	21
18110	95	19126	106	24047	111	26001	107	27838	12	28210	10	28602	9	36171	17	38056	21
18112	95	19127	106	24048	111	26002	107	27840	12	28212	10	28604	9	36172	17	38057	21
18115	95	19128	106	24049	111	26004	107	27842	12	28214	10	28606	9	36173	17	38060	21
18117	95	19131	106	24050	111	26006	74	27844	12	28216	10	28608	9	36174	17	38062	21
18119	29	19132	106	24051	111	26030	31, 107	27846	12	28218	10	28610	9	36175	17	38064	21
18120	96	19134	104	24052	111	26031	31, 107	27848	12	28230	10	28612	9	36176	17	38070	21
18122	96	19136	106	24053	111	26035	31, 107	27850	12	28232	10	28614	9	36177	17	38072	21
18124	96	19137	105	24060	116	26110	108	27852	12	28234	10	28616	9	36180	17	38074	21
18126	96	19139	106	24062	116	26111	108	27854	12	28236	10	28618	9	36181	17	38075	21
18128	96	19140	106	24064	116	26120	108	27856	12	28238	10	28620	9	36202	17	38084	21
18130	96	19141	106	24066	116	26121	108	27858	12	28302	8	28621	9	36203	17	38086	21
18134	96	19146	104	24067	116	26130	108	27860	12	28304	8	28622	9	36204	17	38087	21
18136	96	19149	105	24068	116	26140	108	27862	12	28306	8	28624	9	36205	17	38090	21
18138	96	19150	105	24069	116	26150	108	27864	12	28308	8	28628	9	36206	17	38092	21
18140	96	19151	105	24070	116	26500	30	27866	12	28310	8	28630	9	36207	17	38094	21
18142	96	19152	105	24086	117	26502	30	27868	12	28312	8	28631	9	36210	17	38140	22
18144	96	19153	105	24088	117	26504	30	27870	12	28314	8	28632	9	36216	17	38142	22
18148	95	19155	105	24090	117	26507	30	27872	12	28316	8	28634	9	36218	17	38144	22
18180	97	19158	105	24092	117	26508	30	27876	12	28318	8	28636	9	36226	17	38150	22
18182	97	19159	105	24093	117	26509	30	27880	12	28320	8	28710	10	36312	18	38152	22
18183	97	19160	105	24094	117	26510	31	27888	12	28321	8	28718	10	36314	18	38154	22
18184	97	19190	105	24095	117	26512	31	27892	12	28322	8	28724	10	36320	18	38160	22
18185	97	19191	105	24100	117	26600	30	27896	12	28324	8	28732	10	36322	18	38162	22
18192	97	19196	105	24104	87	26620	30	28010	12	28328	8	28776	9	36328	18	38164	22
18193	97	20000	98	24106	117	26622	30	28012	12	28330	8	28778	9	36340	18	38184	22
18194	97	20002	98	24112	116	26628	30	28014	12	28331	8	28779	9	36346	18	38186	22
18195	97	20004	98	24116	116	26632	30	28016	12	28332	8	28780	9	36348	18	38187	22
18197	97	20005	98	24120	118	26640	30	28018	12	28334	8	28782	9	36350	18	38190	22
18198	97	20006	98	24122	118	26720	30	28020	12	28336	8	28784	9	36356	18	38192	22
18199	97	20008	98	24132	116	26722	30	28022	12	28338	8	28785	9	36358	18	38194	22
18201	95	20010	98	24134	118	26728	30	28024	12	28352	8	28788	9	36360	18	39035	27
18202	95	20012	98	24135	112	26732	30	28026	12	28354	8	28790	9	36366	18	39038	27
18203	95	20014	98	24136	111	26740	30	28028	12	28356	8	28791	9	36368	18	39041	27
18204	95	20032	98	24140	111	27000	15	28030	12	28358	8	30000	119	36385	18	39047	27
18220	95	20034	98	24141	111	27001	14	28032	12	28360	8	30002	119	36496	18	39050	27
18231	100	22000	118	24146	109	27002	14	28034	12	28362	8	30004	119	37018	20	39051	27
18233	100	22105	119	24156	109	27003	14	28036	12	28364	8	30006	119	37019	20	39056	27
18235	100	22150	119	24157	109	27006	14	28038	12	28366	8	30010	119	37023	20	39057	27
18500	101	23000	77	24158	109	27010	15	28040	12	28368	8	30012	119	37025	20	39058	27
18504	101	23001	77	24160	109	27012	15	28042	12	28370	8	30014	119	37030	20	39080	27
18510	101	23007	77	24164	113	27014	15	28044	12	28372	8	30016	119	37032	20	39083	27
18518	101	23008	77	24165	113	27016	15	28046	12	28374	8	30020	119	37038	20	39084	27
18520	101	23009	77	24181	113	27018	15	28048	12	28376	8	30022	119	37039	20	39091	27
18524	101	23010	77	24190	113	27020	15	28050	12	28378	8	30024	119	37040	20	39092	27
19008	104	23011	77	24200	118	27022	15	28052	12	28379	8	30026	119	37042	20	39093	27
19010	104	23013	77	24210	113	27024	15	28054	12	28380	8	30030	119	37044	20	39120	29
19014	104	23050	76	25000	110	27026	15	28056	12	28386	8	30032	119	37045	20	39121	29
19018	104	23052	76	25002	110	27028	15	28058	12	28388	8	30034	119	37046	20	39125	29
19024	104	23053	76	25004	110	27030	15	28060	12	28410	10	30036	119	37047	20	39131	29
19026	104	23057	76	25005	110	27032	15	28062	12	28418	10	30040	119	37048	20	39132	29
19028	104	23058	76	25006	110	27034	15	28064	12	28424	10	30041	119	37049	20	39133	29
19030	104	23059	76	25008	110	27036	15	28066	12	28432	10	30043	119	37050	20	40051	24
19032	104	23061	76	25009	108	27038	15	28068	12	28450	11	30045	119	37052	20	40054	24
19036	104	23062	76	25010	110	27040	15	28070	12	28454	11	30120	119	37054	20	40062	24
19037	104	23063	76	25011	110	27042	15	28072	12	28458	11	30122	119	37055			

Prod.	Pg.	Prod.	Pg.	Prod.	Pg.	Prod.	Pg.	Prod.	Pg.	Prod.	Pg.	Prod.	Pg.	Prod.	Pg.	Prod.	Pg.
40224	24	43066	28	44350	60	44852	62	45316	60	45810	60	46316	44	48156	52	IDC3	71
40226	24	43070	28	44352	60	45000	57	45318	60	45830	63	46317	44	48162	52	IDC4	71
40232	24	43072	28	44354	60	45002	57	45320	60	45832	63	46318	44	48168	52	IDC5	71
40234	24	43074	28	44356	60	45004	57	45322	60	45834	62	46320	44	48300	52	IDC6	71
40244	24	43076	28	44378	60	45006	57	45324	60	45837	62	46326	45	48301	52	IDC7	71
40246	24	43100	28	44380	60	45008	57	45326	60	45838	62	46328	45	48302	52	IHD1	68
40252	24	43102	28	44382	60	45010	57	45328	60	45840	63	46330	45	48304	52	IHD2	68
40254	24	43104	28	44384	60	45012	57	45354	61	45842	63	46332	45	48310	52	IHD3	69
40256	24	43106	28	44386	60	45014	57	45356	61	45936	60	46334	45	48314	52	IHD4	69
40258	24	44000	57	44388	60	45016	57	45358	61	45937	60	46336	45	48318	52	IHD5	69
40648	24	44004	57	44390	60	45019	58	45360	61	45938	60	46338	45	48320	52	IHD6	69
40650	24	44006	57	44392	60	45020	58	45361	61	45939	60	46339	45	48322	52	IHD7	70
40652	24	44008	57	44394	60	45022	58	45362	61	45943	60	46416	42	48324	52	IHD8	70
41010	25	44012	57	44404	61	45024	58	45364	61	45944	60	46420	42	48334	52	IHD9	68
41012	25	44016	57	44406	61	45034	59	45366	61	45945	60	46424	42	48338	52	IHM	63
41018	25	44018	57	44408	61	45036	59	45368	61	45946	60	46432	42	48340	52	IHS	66
41020	25	44020	57	44410	61	45050	63	45386	61	45950	64	46508	42	50000	118	JHD1	10
41022	25	44022	57	44412	61	45052	63	45388	61	45952	64	46512	42	50002	118	JHD2	10
41024	25	44024	57	44414	61	45054	63	45390	61	45953	64	46516	42	50004	118	JSD	11
41030	25	44028	57	44416	61	45056	65	45392	61	45954	64	46520	42	50005	118	KBD1	75
41032	25	44030	57	44418	61	45058	57	45400	60	45955	64	46524	42	50006	118	LMT	93
41050	25	44034	57	44420	61	45060	64	45402	60	45956	64	46528	42	50008	118	LPD	97
41056	25	44038	57	44458	61	45062	64	45404	60	45957	64	46532	42	50010	118	LSB	47
41250	25	44040	57	44460	61	45064	64	45406	60	45959	59	47002	51	50012	118	MAS1	26
41252	25	44042	57	44462	61	45066	64	45408	60	45960	59	47004	51	51002	82	MAS2	26
41254	25	44044	57	44464	61	45067	64	45410	60	45961	59	47006	51	60085	91	MAS3	26
41256	25	44046	57	44466	61	45068	63	45412	60	45962	57	47008	51	60100	94	MAX	52
41262	25	44048	57	44468	61	45069	63	45414	60	45963	57	47012	51	80000	113	MET1	26
41264	25	44052	57	44470	61	45070	59	45416	60	45964	57	47020	51	80010	113	MET2	26
41294	25	44056	57	44472	61	45071	59	45422	61	45965	57	47032	51	ADD	42	MET3	26
41296	25	44066	58	44502	61	45072	59	45424	61	45967	59	47034	51	APD	104	MXC	52
41302	25	44068	58	44504	61	45074	58	45426	61	45968	59	47036	51	APD2	104	NDD	89
41304	25	44070	58	44506	61	45075	58	45427	61	45970	60	47038	51	ASD1	99	NFT1	115
41306	25	44072	58	44508	61	45076	58	45428	61	45971	60	47052	51	ASD2	99	NFT2	114
41308	25	44076	58	44512	61	45078	63	45432	61	45973	65	47054	51	AWD1	95	NLD	41
41648	25	44078	58	44514	61	45080	64	45434	61	45974	65	47056	51	AWD3	95	OSD	29
41650	25	44082	58	44516	61	45082	64	45436	61	45975	65	47060	51	BCD	99	PAL	44
41652	25	44086	58	44518	61	45084	64	45438	61	45976	59	47062	51	BID	42	PAS	44
42000	87	44100	59	44520	61	45086	64	45440	61	45980	41	47064	51	CBD1	19	PBD	118
42001	87	44104	59	44522	61	45087	63	45442	61	45988	41	47068	51	CBD2	19	PBN	83
42002	87	44108	59	44524	61	45088	57	45444	61	46000	67	47072	51	CBD3	19	PDD1	23
42003	87	44110	59	44526	61	45089	63	45446	61	46001	67	47074	51	CBD4	19	PDD2	23
42011	87	44112	59	44528	61	45090	57	45448	64	46002	67	47078	51	CBD5	19	PKD1	77
42013	87	44116	59	44600	63	45091	57	45482	64	46003	67	47080	51	CBD6	19	PKD2	76
42020	87	44118	59	44604	63	45092	57	45484	64	46009	64	47082	51	CBD7	19	PMD1	49
42022	87	44136	59	44608	63	45094	57	45486	64	46010	64	47086	51	CBD8	17	PMD2	49
42023	87	44140	59	44614	63	45095	57	45487	64	46104	48	47090	51	CCD	85	PMM1	92
42040	87	44142	59	44616	63	45096	57	45488	64	46106	48	47096	51	CDD	39	PMM2	92
42041	87	44146	59	44620	63	45098	63	45490	64	46108	48	47100	51	CGD	31	PSM1	89
42200	28	44150	59	44622	63	45099	63	45492	64	46110	48	47102	51	CJH1	70	PSD2	89
42201	28	44152	59	44628	62	45124	57	45494	64	46112	48	47106	51	CJH2	70	PTM1	113
42202	28	44154	59	44636	64	45126	57	45510	65	46114	48	47116	51	CJH3	70	PTM2	111
42203	28	44164	59	44638	64	45144	57	45511	65	46116	48	47118	51	COD	33	PWD	104
42206	28	44200	58	44640	64	45148	57	45512	65	46118	48	47122	51	CRD1	56	QCD	33
42207	28	44202	58	44642	64	45156	57	45515	65	46120	48	47130	51	CRD2	56	RBD1	8
42208	28	44204	58	44644	64	45158	57	45516	65	46122	48	47134	51	CSD	50	RBD2	9
42209	28	44206	58	44648	64	45170	59	45517	65	46124	48	47138	51	DBD1	32	RBD3	9
42218	28	44210	58	44650	64	45175	59	45525	65	46126	48	47142	51	DBD2	34	RFD	29
42219	28	44212	58	44652	64	45176	59	45534	65	46128	48	47185	50	DBD3	36	RSD	89
42220	28	44214	58	44654	64	45182	59	45548	65	46130	48	47187	50	DBD4	38	SAD	33
42221	28	44230	58	44656	64	45184	59	45554	65	46132	48	47190	51	DBD5	40	SAM	45
42300	29	44232	58	44658	64	45200	59	45600	50	46134	48	47202	51	DHS	23	SBD	46
42301	29	44234	58	44660	64	45202	59	45602	50	46152	48	47204	51	DMC2	34	SDC	50
42302	29	44238	58	44662	64	45220	59	45604	50	46180	48	47206	51	DMC3	36	SDD	43
42303	29	44240	58	44664	64	45222	59	45606	50	46182	48	47208	51	DMC4	39	SDS1	51
42306	29	44242	58	44688	65	45232	59	45608	50	46184	48	47232	51	DPD	22	SFD	47
42307	29	44250	60	44690	65	45248	58	45616	50	46204	44	47234	51	DSD1	32	SJD	96
42308	29	44252	60	44692	65	45250	58	45629	66	46205	44	47236	51	DSD2	35	SPD	83
42309	29	44256	59	44694	65	45260	58	45630	66	46206	44	47252	51	DSD3	37	SPL	52
42324	29	44258	59	44696	65	45266	58	45632	66	46207	44	47260	51	DSD4	39	SSE	37
42325	29	44260	59	44698	65	45268	58	45636	63	46208	44	47278	51	DTD	35	TCD1	103
42326	29	44262	59	44706	65	45270	58	45638	46, 63	46209	44	47300	50	FCT	109	TCD2	103
42327	29	44264	59	44708	66	45274	59	45640	46, 63	46210	44	47302	50	FDD	28	TCD3	103
42370	29	44266	59	44710	66	45275	59	45642	46, 63	46211	44	47304	50	FRD	87	TSD	89
42371	29	44306	60	44712	66	45276	59	45700	58	46212	44	48068	52	FSB	48	TTD	107
42372	29	44308	60	44720	65	45277	59	45702	58	46213	44	48080	52	FSD1	81	WCD	82
42373	29	44310	60	44732	65	45278	59	45703	58	46214	44	48082	52	FSD2	81	WSC	101
42374	29	44312	60	44734	65	45284	59	45704	58	46215	44	48083	52	FSD3	81		
42390	29	44314	60	44736	65	45290	60	45706	58	46216	44	48084	52	FSD4	81		
42391	29	44316	60														

A

Abrasives	
Blades and Wheels	24 - 26
Flap Discs	28
Sanding Belts & Discs	28 - 29
Sanding Sponges	87
Wire Wheels & Brushes	27
Adapters, Steel	13, 23
Arbors	
Hole Saw	13, 30
Router Bit	56
Auger Bits	44 - 45
Awl	82
Axes & Hatchets	80

B

Ball Bearings, Router Bit	56
Bit Extensions	46 - 48, 62 - 63
Bolt Cutters	99
Brick Jointers	111
Brick Tonges	111
Buffing Wheels	29

C

Carbide Glass Cutter	74
Carbide Grit Blades & Saws	30 - 31
Casters	119
Caution & Warning Tape	119
Chisels	
SDS Plus®, SDS Max®	50, 52
Wood	82
Circular Saw Blades	
Abrasive, Metal & Masonry	24 - 26
Carbide Tipped	16 - 19
Diamond	20 - 23
Fiber Cement	18, 21
Non-Ferrous, Plastic, Steel	17 - 18
Clamps	85
Corner Bead Tool	118
Countersinks	33
Cut-off Blades	24 - 26

D

Deburring Tools	105
Depressed Center Wheels	24 - 26
Diamond Saw Blades	20 - 23
Drill Bits	
Aircraft	42
Auger Bits	44 - 45
Bell Hanger	42
Brad Point	45
Cobalt	38 - 39
Concrete (Tapcon®)	50
Double-End	41
Forstner Bits	48
Glass & Tile	52
High Molybdenum Steel	36 - 37
High Speed Steel, Forged	32 - 33
M2 High Speed Steel, Ground	34 - 35
Installer	42
Left Hand	37
Letter	41
Masonry	49 - 52
Pilot	13
Quick Change	33
SDS Plus® Hammer	50 - 51
SDS Max® Hammer	52
Spline	52
Self-Feed	47
Silver & Deming	33
Spade Bits	46 - 47
Wire Gauge	40 - 41
Drywall Tools	116 - 118
Dust Masks	119

E

Electrical Wire Cutters/Strippers	101
-----------------------------------	-----

F

Files	86 - 87
Flap Discs	28
Flaring Tool	105
Floats	108 - 109
Floor Scraper & Blades	75
Forstner Bits & Sets	48

G

Glass Cutter, Carbide	74
Glue Gun & Hot Melt Glue	118
Grout Saws	31, 107

H

Hacksaw Blades	10 - 11, 30
Hacksaws	93 - 94
Hammers	78 - 81
Hand Saws	84 - 85
Hawks, Aluminum	116
Hex & Torx Key Sets	91
Hole Saws	
Bi-Metal	12 - 15
Carbide Grit	30
Diamond Grit	23, 31
Hole Saw Kits	
Bi-Metal	14 - 15
Carbon-steel	14

I

Insert, Power Bits, & Holders	57 - 71
Installation Kits	
Concrete Screw (Tapcon®)	50
Lock	14 - 15

J

Jig Saw Blades	10 - 11, 30
----------------	-------------

K

Knives	
Break-Away & Blades	74
Carpet	74
Folding	73
Linoleum	74
Putty	76 - 77
Roofing	73
Taping	76 - 77, 116
Utility - Fixed, Folding & Retractable	72 - 73

L

Lock Installation Kits	14 - 15
Locking Pliers	97

M

Mallets, Rubber	79
Masonry Bits	49 - 52
Measuring Tapes	92 - 93
Mega-Magnetic® Bit Holders	62 - 63
Mega-Magnetic® Screwdrivers	90 - 91
Mud Mixers & Pans	116 - 117

N

Nail Claw & Puller	82 - 83
--------------------	---------

P

Paint Brushes	118
Pegboard Hooks	119
Pipe Clamp	85
Pipe Cutters	102 - 103
Pliers	95 - 97, 100
Planes	83
Plumbing Tools	102 - 106
Power Bit Holders & Drivers	62 - 71
Pry Bar, IVY Bar	82 - 83
Putty Knives	76 - 77
PVC Cutters	102 - 103

R

Razor Blades	73
Rebar Cutter & Bender	100
Reciprocating Saw Blades	8 - 9, 30
Rivet Tool	85
Router Bits, Carbide	53 - 56

S

Safety Goggles	118
Sanding Tools	
Flap Discs	28
Hand Sanders - Drywall	117
Sanding Belts	28
Sanding Discs	29
Sanding Sponges	87
Universal Pole Sander	117
Saw Blades	
Circular	16 - 19
Reciprocating	8 - 9, 30
Saws	
Hand Saws	84 - 85
PVC Cable Saw	103
Rod Saws	31
Scrapers	
Floor	75
Heavy-Duty Pole	75
Paint	73, 75 - 77
Razor Blade	73
Wall Stripper	75
Screw Extractors - Spiral	37
Screwdrivers	88 - 91
Screwdriving Sets	67, 88, 91
Shaping Planes	83
Sharpening Stone	82
Snips	98 - 99
Spade Bits	46 - 47
Step Drills	43
Swaging Tool	105

T

Tap/Drill Bit Combo	35
Taping Tools	76 - 77, 116 - 118
Tie Wire Twister	112
Tile Cutters & Nippers	107
Tile Cutting Machines	108
Trowels	110 - 115
Tubing Benders	105
Tubing Cutters	102 - 103

U

Utility Knives & Blades	72 - 74
-------------------------	---------

W

Wall Scraper & Blades	75
Wire Cutters	99 - 101
Wire Wheels & Brushes	27
Wood Bits	44 - 48
Wood Chisels	82
Wool Bonnets	29
Wrenches	
Adjustable	95
Basin	104
Grinder Pin	89
Pipe	95, 104
Plumbing Specialty	106
Socket, 16-in-1	94



IVY Classic Industries, Inc.

40 Plain Avenue • New Rochelle, NY 10801

Tel: 914-632-8200 Fax: 914-632-6449

800-435-3867 800-552-2997

www.ivyclassic.com

e-mail: sales@ivyclassic.com

IVY Classic®



IVY Classic Industries, Inc.

40 Plain Avenue • New Rochelle, NY 10801 USA

Tel: 914-632-8200

Fax: 914-632-6449

800-435-3867

800-552-2997

www.ivyclassic.com

e-mail: sales@ivyclassic.com