

# Deep hole drilling

Product catalogue and application guide





# Sandvik Coromant Not only a tool supplier

Sandvik Coromant is the world leading supplier of cutting tools and tooling systems for the metal working industry represented by sales personnel and specialists in 60 countries.

Three central stocking points ensure efficient distribution to customers all over the world, in most markets, within 24 hours.

## Our mission is simple:

To help our customers improve their productivity and profitability. Our products, know-how and services shall give maximum value to our customers in terms of performance, quality, security, flexibility and total economy.

## Full control from powder...

With the most advanced production system and the latest technology we control the entire process from raw material to final product.

## ... to recycling

And we also play our part when it comes to the future of our world – by collecting used carbide for recycling in an eco-friendly way. Sandvik Coromant is certified according to ISO 9001, ISO 14001 and OHSAS18001.

## No limits with Sandvik Coromant

### Tailor Made options ...

Tools to your dimensions on standard tool terms. With our Tailor Made Service you are free to specify your own dimensions without paying the price of a special tool.

- Prompt delivery of drawing and quote.
- Tools within 10 to 20 days.

### and engineered solutions

When standard and Tailor Made solutions do not fulfil your needs you can depend on Sandvik Coromant's wide experience in engineered tool solutions to cope with particularly demanding criteria.

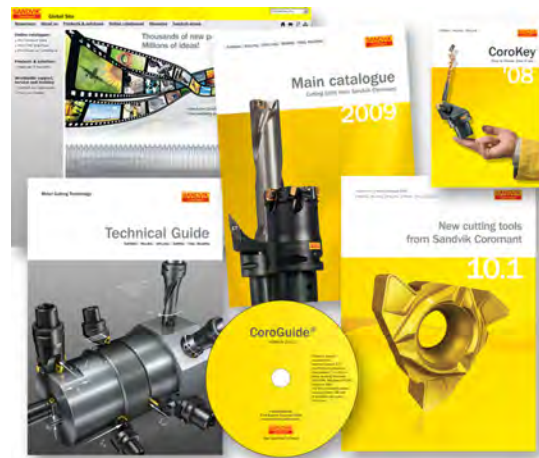

## More information?

Useful information and application techniques are found in our special catalogues, application guides and handbooks.

CoroGuide Web is an internet based catalogue, including a cutting data module (also available on CD) where you can find cutting data recommendations for your specific application.

Visit our web site for the latest news! And you will also find many applicable functions and services.

[www.coromant.sandvik.com](http://www.coromant.sandvik.com)

## ShopOnline

ShopOnline is our ordering service on the Internet – an easy way to order products. By using this service you will get online information about net prices and the stock situation.

ShopOnline is now available to customers in about 46 markets.

How to register? See our website [www.coromant.sandvik.com](http://www.coromant.sandvik.com)

This work is published with the understanding that Sandvik Coromant and its editors are supplying information aimed to present a general orientation and direction for metal cutting and related sciences. If professional services are required for specific applications, the assistance of an appropriate professional should be acquired. The information is provided "AS-IS." SANDVIK COROMANT AND ITS EDITORS DISCLAIM ALL REPRESENTATIONS AND WARRANTIES, EXPRESS OR IMPLIED, OF ANY KIND, INCLUDING, WITHOUT LIMITATION, ANY WARRANTIES OF MERCHANTABILITY, FITNESS FOR A PARTICULAR PURPOSE, TITLE OR NONINFRINGEMENT. IN NO EVENT WILL SANDVIK OR ITS EDITORS BE LIABLE TO ANY PARTY FOR ANY DIRECT, INDIRECT, SPECIAL OR OTHER CONSEQUENTIAL DAMAGES FOR ANY USE OF THE INFORMATION, EVEN IF SANDVIK OR ITS EDITORS ARE ADVISED OF THE POSSIBILITY OF SUCH DAMAGES.

# DEEP HOLE DRILLING

<b>Introduction</b>	4
<b>Ejector system</b>	7
<b>STS system</b>	43
<b>CoroDrill® 805</b>	109
Deep holes in conventional machines	
<b>Gun drilling</b>	111
<b>Application guide</b>	119
<b>Index</b>	161



# Deep hole drilling

high material removal rate with high accuracy

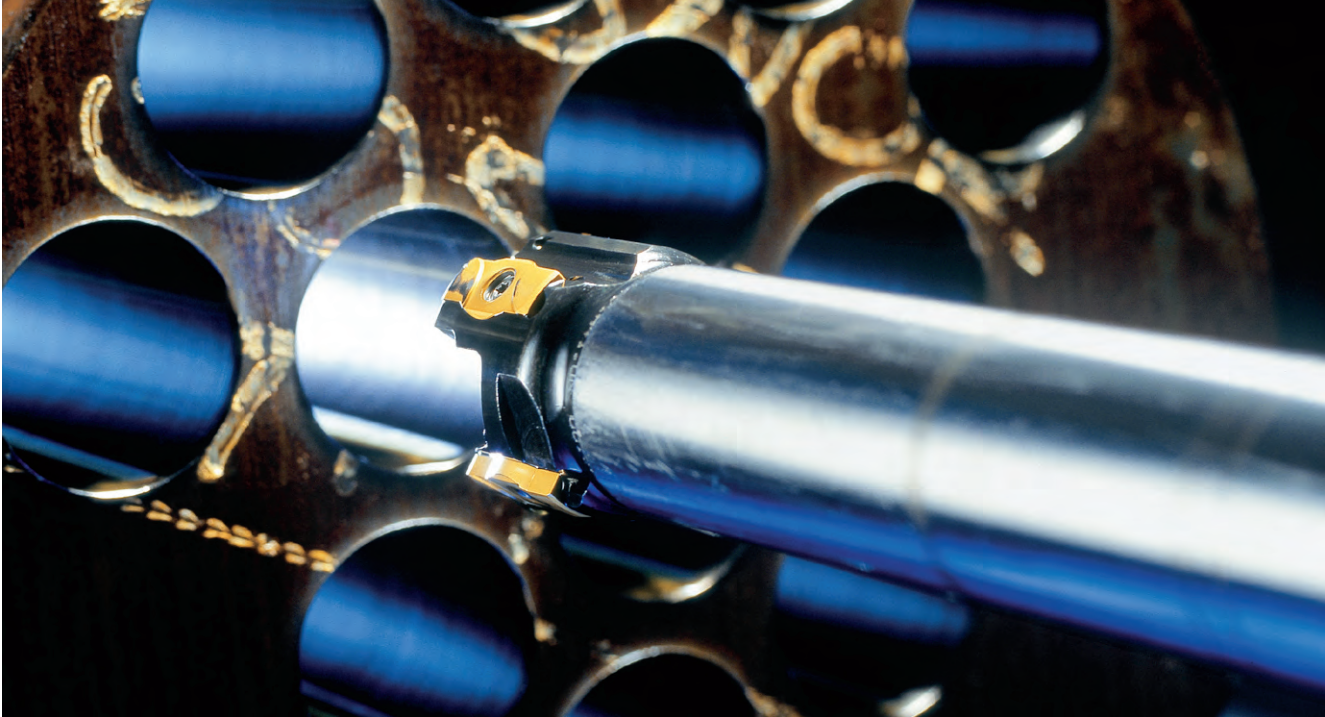

For troublefree production – try the first deep hole drill for Ejector/STS with indexable inserts and fixed insert pockets.

Deep hole drilling is the machining of holes with a relatively large depth to diameter ratio. Whereas normal drilling techniques produce holes where the depth is rarely more than five times the diameter. In deep hole drilling the ratio may reach 150:1, and any hole deeper than ten times the diameter should certainly be considered a deep hole, requiring a specialised drilling technique.

Deep hole drilling can employ various machine set-ups: rotating workpiece, rotating tool, or both tool and workpiece rotating. The most common, however, is for the workpiece to rotate, while the tool supplies the linear feed movement.

Whichever set-up is employed, the basic principles of drilling still apply, and the correct choice of cutting speeds and feeds are still crucial. Satisfactory chip breaking, and removing the chips from the cutting edges without damaging tool or workpiece, is essential.

Gun drilling is capable of producing smaller holes than the Single Tube System (STS), but the STS system is far more productive (4 – 6 times) and should always be the first choice when possible. The Ejector system is an alternative to STS when drilling smaller batch quantities while it does not require a special machine.





# Different deep hole drilling systems

In deep hole drilling, a combination of tool design and cutting fluid pressure are used to flush the chips out of the hole. Three different drill systems are common.

All three systems can produce holes with excellent surface finish, close dimensional tolerance and concentricity.

## The Ejector system

Is similar to STS, except that the drill is connected to an inner and outer tube. Cutting fluid is pumped down the drill between the two tubes, ie. entirely within the drill body rather than externally, and the chips are flushed back out through the inner one, also within the drill body.

This self-contained system requires less fluid pressure than the STS system and can usually be installed in conventional machine tools without major reconstruction.

## The single tube system or STS

High pressure pumps supply cutting fluid down the outside of the drill tube, between the drill and the drilled hole.

The drill shank itself is hollow, and the fluid pressure flushes the chips into the drill body through chiprooms in the drill head, and back out through the drill tube.

The high cutting fluid pressure makes the STS-system more reliable than the Ejector system especially when drilling materials where good chipbreaking is difficult to obtain i.e. low carbon steels and stainless.

The STS-system is always the first choice for long series production.

## The Gun drill system

The gun drill shank is hollow, and cutting fluid is pumped inside it down the length of the tube from an external supply, and forced out through holes in the cutting head.

The drill shank has an exterior V-shaped groove or flute along its length, and the fluid pressure flushes the cut chips back along this groove, along the outside of the drill, and so out of the hole. The gun drill can be applied to a conventional machining centre, but high cutting fluid pressure is required.

For more information about the systems see Application guide, page 120.

# We are dedicated to supply your needs



Our technical staff will help you to reach your objectives in your applications.

We provide you with quality products suitable for your business. Add to that our technical service, delivery and commercial service.

Together, we can strengthen your competitiveness. By working partner-oriented we contribute to improve your productivity, production economy and machine utilization.

Sandvik Coromant also recognizes your increasing demands for environmental concerns and offer a service to collect used carbide inserts, which are broken down to their original raw material state – in the most eco-friendly way.

# DEEP HOLE DRILLING

<b>Ejector system</b>	
Choice of tools	<b>8-9</b>
Tool mounting – solid drilling and counterboring	<b>10-11</b>
Ground drill head 424.6	<b>12-15</b>
CoroDrill® 800.24	<b>16-19</b>
T-Max® drill 424.10	<b>20-24</b>
Drill tubes manufactured by customer request	<b>25</b>
Calculation of special length tubes	<b>25</b>
T-Max® 424.31F and 424.31 counterboring heads	<b>26-33</b>
Mounting parts for rotating and non-rotating connectors	<b>34-35</b>
Rotating connectors	<b>36</b>
Non-rotating connectors	<b>37</b>
Drill mounted connectors-non-rotating	<b>38</b>
Drill tubes suitable for drill mounted connectors	<b>38</b>
Varilock adapted connector for automatic tool change	<b>39-41</b>
Vibration dampers	<b>76</b>
Adaptors converting from external to internal tube threads	<b>77</b>
Setting the diameter on T-Max® heads	<b>78</b>
Inserts	<b>79-85</b>
Cutting data and graphs	<b>86-98</b>
Spare parts	<b>99-108</b>
<b>Application guide</b>	<b>119</b>
<b>Trouble shooting</b>	<b>151-152</b>
<b>Material cross reference list</b>	<b>153-157</b>
<b>Insert mounting</b>	<b>158</b>
<b>Safety information</b>	<b>159</b>
<b>Index</b>	<b>161</b>

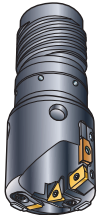

Data and applications	Ejector Solid drilling		Ejector Solid drilling	Ejector Counterboring		
	424.6	800.24	424.10	424.31F	424.31	424.32
<ul style="list-style-type: none"> <li>• Solid drill heads</li> <li>• Trepanning heads</li> <li>• Counterboring heads</li> <li>• Gun drills</li> </ul>  <p>Drill diameter, <math>D_c</math> Drilling depth, <math>l_4</math></p>						
	18,40–65,00 $100 \times D_c$	25,00–65,00 $100 \times D_c$	$\geq 63,50$ $100 \times D_c$	20,00–124,99 $100 \times D_c$	$\geq 65,00$ $100 \times D_c$	$\geq 75,00$ $100 \times D_c$
Page	12	16	20	26	26	71
Surface finish Ra	2 $\mu\text{m}$	2 $\mu\text{m}$	3 $\mu\text{m}$	1 $\mu\text{m}$	3 $\mu\text{m}$	3 $\mu\text{m}$
Hole tolerance	IT9	IT10	IT10	IT9 – 10	IT10	IT10
Machine						
– DHD machines		Yes	Yes		Yes	
– NC machines		Yes	Yes		Yes	
– Lathes		Yes	Yes		Yes	
– Most conventional machines		Yes	Yes		Yes	
– Machining centres		Yes	Yes		Yes	
– Special gun drilling machines		–	–		–	
Workpiece material						
– Steel	<b>P</b> ◆◆◆	◆◆◆	◆◆◆	◆◆◆	◆◆◆	◆◆◆
– Stainless steel	<b>M</b> ◆	◆◆	◆◆◆	◆◆◆	◆◆◆	◆◆◆
– Cast iron	<b>K</b> ◆◆◆	◆◆◆	◆◆◆	◆◆◆	◆◆◆	◆◆◆
– Aluminium alloys	<b>N</b> ◆◆	◆◆◆	◆◆◆	◆◆	◆◆	◆◆
– Heat resistant alloys	<b>S</b> ◆	◆◆	◆◆◆			
Tool						
– Internal cutting fluid supply	Yes	Yes	Yes	Yes	Yes	Yes
– Insert type	–	800-XX T3 08M 800-XX T3 08H	TPMT/R424.9 TPMX/TPUN	R424.31F/ SNMG/SNMM	TPMX/TPUN SNMG/SNMM	TPMT/R424.9
Cutting data	See pages 86-98					

Good = ◆◆◆ ←————→ ◆ = Fair

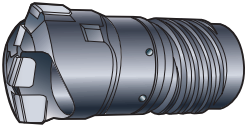
**Ground drill head 424.6**

- 4-6 times faster than gun drilling
- The first choice for hole diameters 18,40-24,99 mm or for dia. 25,00-65,00 mm when extra close diameter tolerance is demanded
- Low investment cost for small batch production
- Standard programme

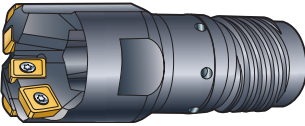
**CoroDrill® 800.24**

- The most productive choice for diameter range 25,00-65,00
- Lowest cost per hole
- Consistent performance within a wide application range
- Standard programme
- Developed and manufactured with the latest technology

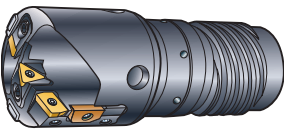
**T-MAX® drill 424.10**

- The choice for larger diameters starting from 63,50 mm
- Setting possibilities on diameter
- Good hole straightness in long workpieces
- Stocked standard programme
- Wide range of Tailor Made and engineered solutions

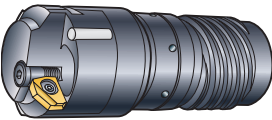
**T-MAX® 424.31F counterboring head – on request**

- When demands for precision, productivity and versatility are high
- Single insert design
- Adjustable insert cartridge head
- Stocked standard components

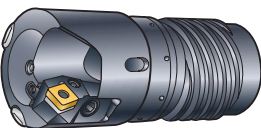
**T-MAX® 424.31 counterboring head – on request**

- When demands for productivity and versatility are high
- Single insert design
- Adjustable insert cartridge head
- Stocked standard components

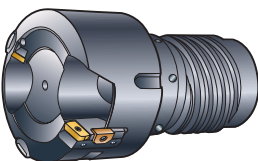
**T-MAX® 424.32 counterboring head – on request**

- Multi-insert design
- Adjustable insert cartridge head
- Wide range of engineered solutions
- Stocked standard components

### Tool mounting – solid drilling and counterboring

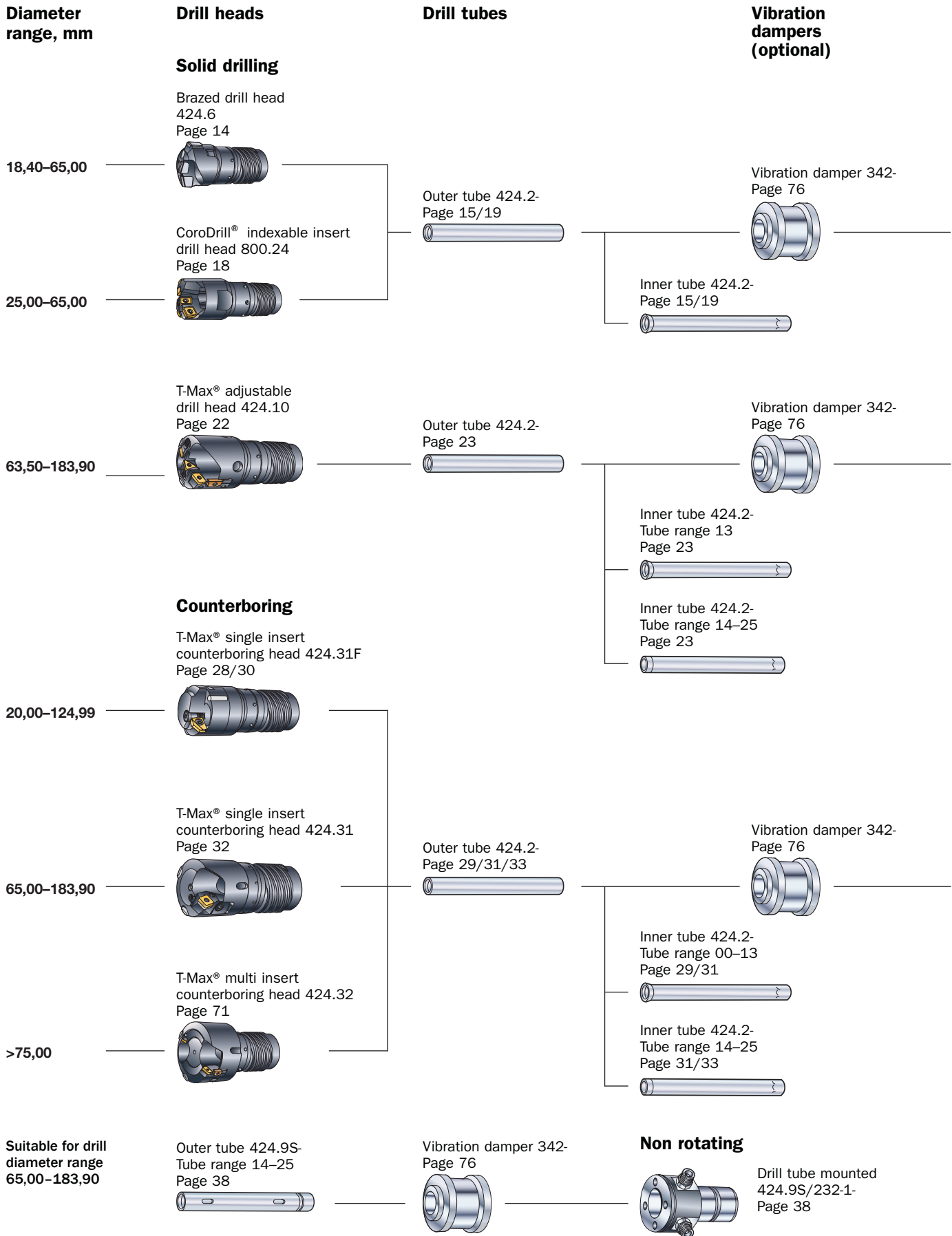



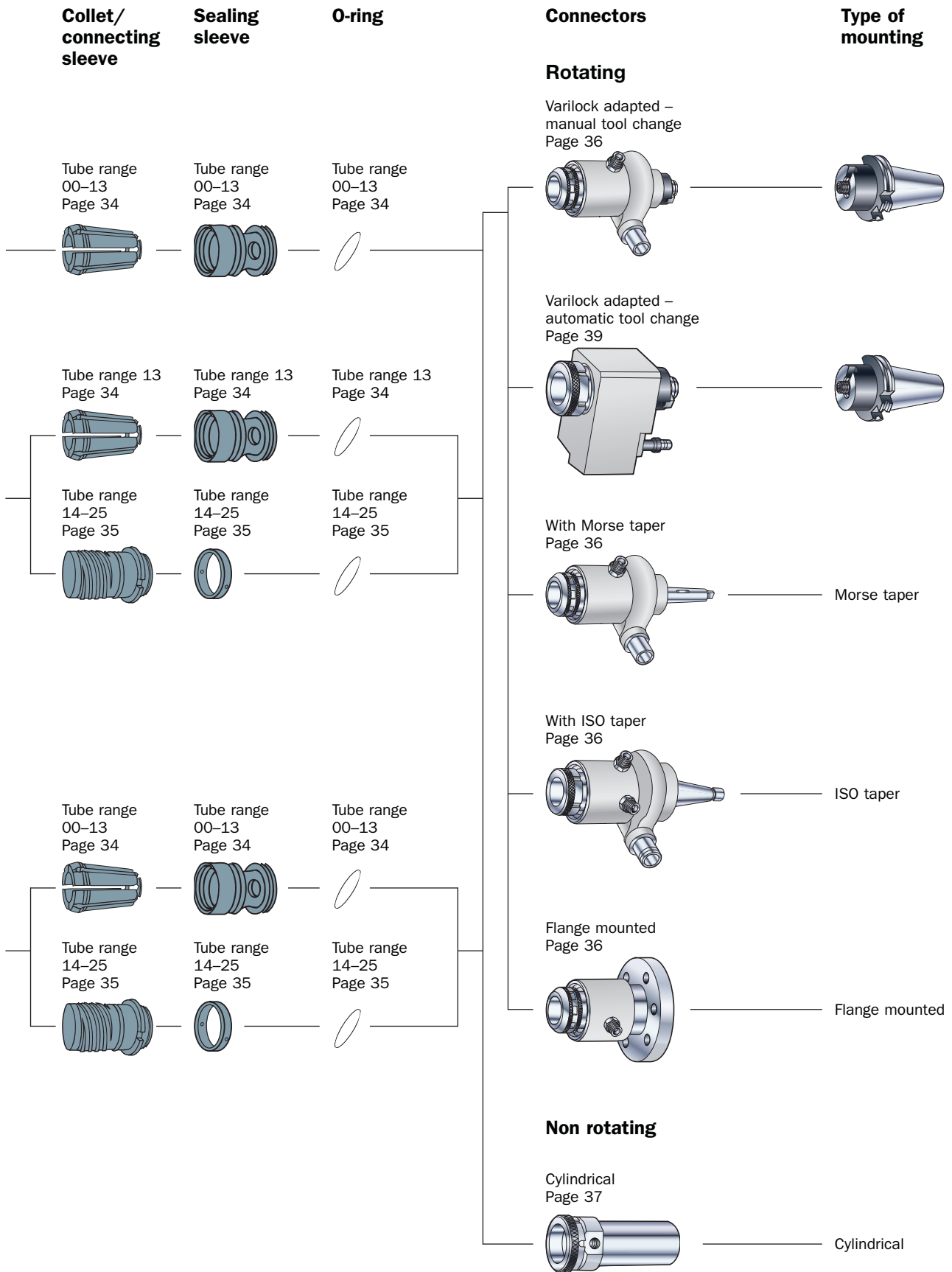

# Ground drill head 424.6

*"The original" precision drill*

Diameter range 18,40 – 65,00 mm

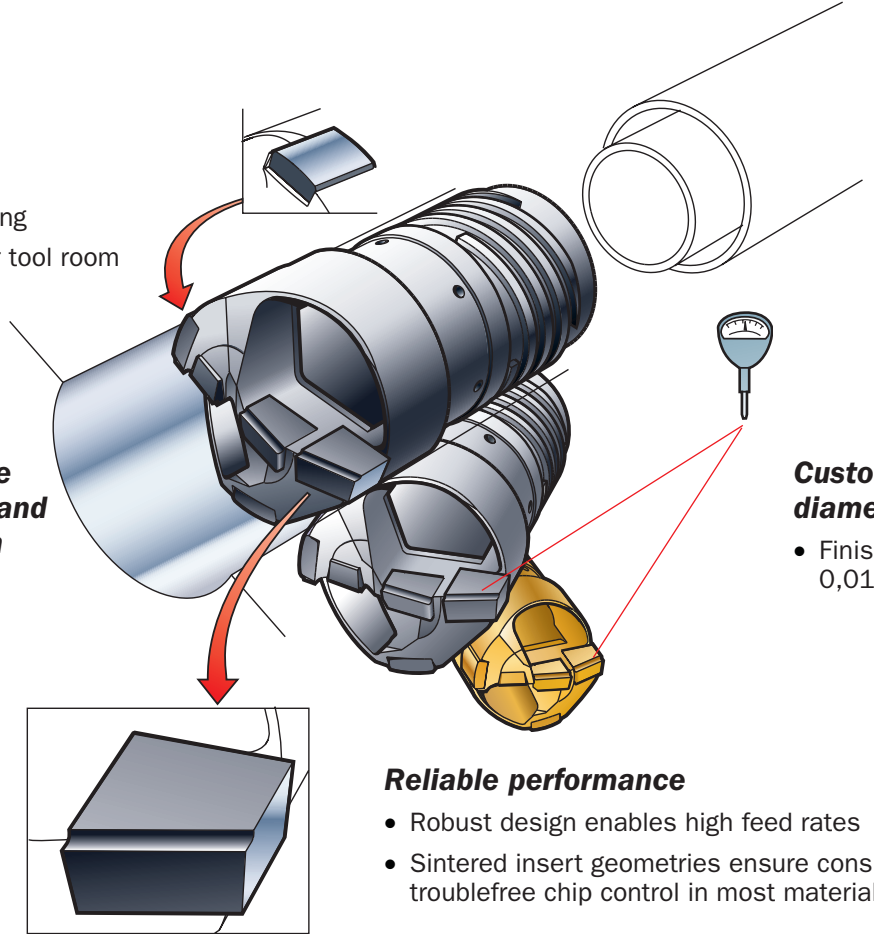

**Easy to use**

- No pre-setting
- No need for tool room service

**Excellent hole straightness and surface finish**

**Customer specified diameter**

- Finish ground within 0,01 mm increments

**Reliable performance**

- Robust design enables high feed rates
- Sintered insert geometries ensure constant troublefree chip control in most materials

**Wide application area**

- Optimized grade- and geometry combinations for most workpiece materials

## Ground drill head 424.6

- 4 to 6 times faster than gun drilling
- The first choice for hole diameters 18,40 – 24,99 mm, or in diameter range 25,00 – 65,00 when extra close diameter tolerance is demanded
- Low investment cost for small batch production
- Standard programme

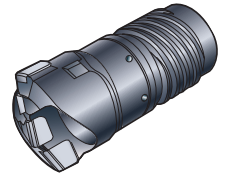

### Preferred Ejector applications

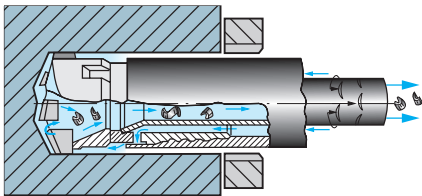

- Modified lathes
- Economical and easy to apply to horizontal boring machines
  - NC lathes
  - Maching centres
- Transfer lines
- Easy machining workpiece materials

### Typical components – Industry segments

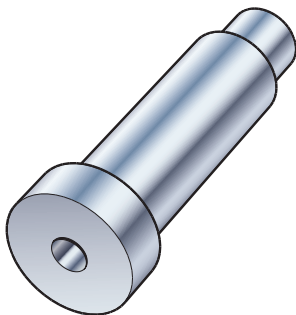

#### Automotive/truck industry

- Axles, piston pins
- Engine block (diesel)
- Hydraulic cylinder
- Track links

#### Process industry

- Oil holes

#### Ship yard

- Coolant/oil holes in engine blocks

#### General engineering workshops

- M/C applications
- Mixed production – short series

#### Machine spindle

Drill dia,  $D_C$  : 39,10 mm

Drill depth,  $l_4$  : 457 mm

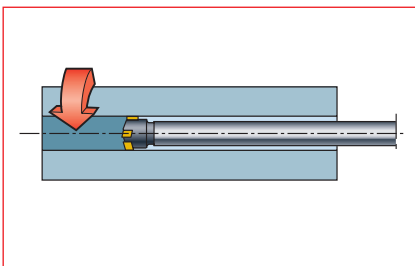

#### Shank

Drill dia,  $D_C$  : 50,00 mm

Drill depth,  $l_4$  : 2000 mm

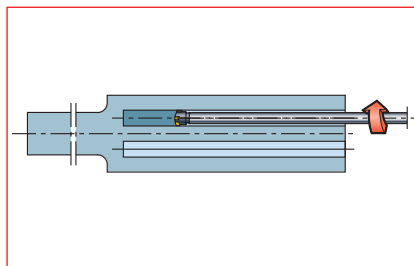

#### Stay axle

Drill dia,  $D_C$  : 24,00 mm

Drill depth,  $l_4$  : 1360 mm

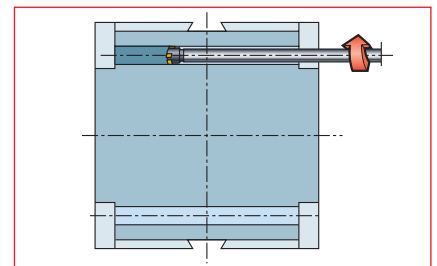

#### Cylinder

Drill dia,  $D_C$  : 32,00 mm (x 26)

Drill depth,  $l_4$  : 900 mm



## Ejector drill programme - Ground brazed solid drill head 424.6

Diameter range  
18,40 – 65,00 mm

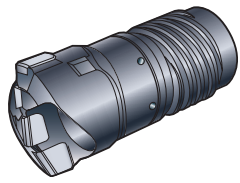

Diameter range: 18,40–65,00 mm  
 Hole depth horizontal: 100 × Dia.  
 Hole depth vertical: 50 × Dia.  
 Hole tolerance: IT 9  
 Surface finish:  $R_a$  2  $\mu$ m  
 Cutting fluid: Neat oil or soluble

Drill heads are delivered with standard chipbreaker, finish ground to the desired diameter to tolerance ISO h6.

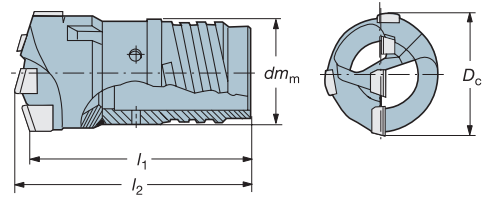

$dm_m$  is the same as  $dm_t$  for the drill tube

Diameter range, mm	Tube range	Ordering code, Drill head	P	M	K	N	S	Dimensions, mm			
			Chipbreaker (w)						Tolerances, mm		
			4	4	3	4	4	4	$l_2 = \pm 1,0$	$l_1 = \pm 1,0$	$dm_m = h8$
$D_c$ mm			Coromant grade combination (zz) <sup>1)</sup>						$dm_m$	$l_2$	$l_1$
			70	63	67	72	72	72			
18,40–19,20 19,21–20,00	00	424.6- 001w Dxx.xx zz 002w Dxx.xx zz	★ ☆ ★	★	★	★	★	★	16	50,0	47,1
20,01–20,90 20,91–21,80	01	424.6- 011w Dxx.xx zz 012w Dxx.xx zz	★ ☆ ★	★	★	★	★	★	18	56	52,9
21,81–22,90 22,91–24,10	02	424.6- 021w Dxx.xx zz 022w Dxx.xx zz	★ ☆ ★	★	★	★	★	★	19,5	56,0	52,8
24,11–25,20 25,21–26,40	03	424.6- 031w Dxx.xx zz 032w Dxx.xx zz	★ ☆ ★	★	★	★	★	★	21	57,5	54,0
26,41–27,50 27,51–28,70	04	424.6- 041w Dxx.xx zz 042w Dxx.xx zz	★ ☆ ★	★	★	★	★	★	23,5	60,5	56,8
28,71–29,80 29,81–31,00	05	424.6- 051w Dxx.xx zz 052w Dxx.xx zz	★ ☆ ★	★	★	★	★	★	25,5	63,5	59,5
31,01–32,10 32,11–33,30	06	424.6- 061w Dxx.xx zz 062w Dxx.xx zz	★ ☆ ★	★	★	★	★	★	28	63,5	59,4
33,31–34,80 34,81–36,20	07	424.6- 071w Dxx.xx zz 072w Dxx.xx zz	★ ☆ ★	★	★	★	★	★	30	70,5	66,0
36,21–37,30 37,31–38,40 38,41–39,60	08	424.6- 081w Dxx.xx zz 082w Dxx.xx zz 083w Dxx.xx zz	★ ☆ ★	★	★	★	★	★	33	73,5	68,7
39,61–40,60 40,61–41,80 41,81–43,00	09	424.6- 091w Dxx.xx zz 092w Dxx.xx zz 093w Dxx.xx zz	★ ☆ ★	★	★	★	★	★	36	73,5	68,2
43,01–44,30 44,31–45,60 45,61–47,00	10	424.6- 101w Dxx.xx zz 102w Dxx.xx zz 103w Dxx.xx zz	★ ☆ ★	★	★	★	★	★	39	75,0	69,5
47,01–48,50 48,51–50,10 50,11–51,70	11	424.6- 111w Dxx.xx zz 112w Dxx.xx zz 113w Dxx.xx zz	★ ☆ ★	★	★	★	★	★	43	79,0	72,8
51,71–53,20 53,21–54,70 54,71–56,20	12	424.6- 121w Dxx.xx zz 122w Dxx.xx zz 123w Dxx.xx zz	★ ☆ ★	★	★	★	★	★	47	82,0	75,2
56,21–58,40 58,41–60,60 60,61–62,80 62,81–65,00	13	424.6- 131w Dxx.xx zz 132w Dxx.xx zz 133w Dxx.xx zz 134w Dxx.xx zz	★ ☆ ★	★	★	★	★	★	51	84,0	77,2

<sup>1)</sup> Drills with other grade combinations are available on request.

★ = First choice

When ordering drill heads, state chipbreaker No (w) drill diameter (xx.xx) and grade combination (zz) in the ordering code.

Ordering example: 2 pieces 424.6-0014 D\*18,40\* 70

### SAFETY INFORMATION

Precautions when grinding and brazing of cemented carbide, see page 159.



**Drill head**

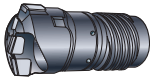

**424.6**  
Diameter range  
18,40–65,00 mm

**Outer tube**

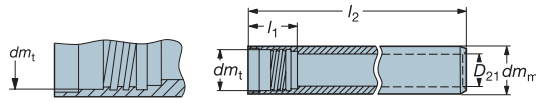

**Inner tube**

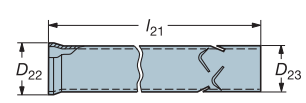

**Note!**

Drill tubes are supplied threaded in both ends, with an internal thread, the E-thread.

$dm_t$  is the same as  $dm_m$  for the drill

Diameter range, mm	Tube range	Ordering code Outer tube <sup>1)</sup>	Dimensions, mm						Ordering code Inner tube <sup>1)</sup>	Dimensions, mm					
			Standard length $l_2$							Standard length $l_{21}$					
			400	630	1070	$dm_m$	$dm_t$	$D_{21}$		$l_1$	430	660	1100	$D_{22}$	$D_{23}$
$D_c$ mm															
18,40–19,20 19,21–20,00	00	424.2-800-	2	3	4	18	16	12	27,5	424.2-850-	2	3	4	12	10
20,01–20,90 20,91–21,80	01	424.2-801-	2	3	4	19,5	18	4	30	424.2-851-	2	3	4	14	12
21,81–22,90 22,91–24,10	02	424.2-802-	2	3	4	21,5	19,5	15	30	424.2-852-	2	3	4	15	13
24,11–25,20 25,21–26,40	03	424.2-803-	2	3	4	23,5	21	16	30	424.2-853-	2	3	4	16	14
26,41–27,50 27,51–28,70	04	424.2-804-	2	3	4	26	23,5	18	33	424.2-854-	2	3	4	18	16
28,71–29,80 29,81–31,00	05	424.2-805-	2	3	4	28	25,5	20	33	424.2-855-	2	3	4	20	18
31,01–32,10 32,11–33,30	06	424.2-806-	2	3	4	30,5	28	22	33	424.2-856-	2	3	4	22	20
33,31–34,80 34,81–36,20	07	424.2-807-	2	3	4	33	30	24	40	424.2-857-	2	3	4	24	22
36,21–37,30 37,31–38,40 38,41–39,60	08	424.2-808-	2	3	4	35,5	33	26	40	424.2-858-	2	3	4	26	24
39,61–40,60 40,61–41,80 41,81–43,00	09	424.2-809-	2	3	4	39	36	29	40	424.2-859-	2	3	4	29	27
43,01–44,30 44,31–45,60 45,61–47,00	10	424.2-810-	2	3	4	42,5	39	32	40	424.2-860-	2	3	4	32	30
47,01–48,50 48,51–50,10 50,11–51,70	11	424.2-811-	2	3	4	46,5	43	35	44	424.2-861-	2	3	4	35	32
51,71–53,20 53,21–54,70 54,71–56,20	12	424.2-812-	2	3	4	51	47	39	44	424.2-862-	2	3	4	39	36
56,21–58,40 58,41–60,60 60,61–62,80 62,81–65,00	13	424.2-813-	2	3	4	55,5	51	43	44	424.2-863-	2	3	4	43	40

<sup>1)</sup> Other lengths can be manufactured by **customer request**, see page 25.

Ordering example for outer tube length 400 mm and inner tube 430 mm fitting drill head  $D_c = 18,40$  mm:

**1 piece 424.2-800-2 and 1 piece 424.2-850-2**

**NOTE!**

The inner tube must be ordered 30 mm longer than the outer tube.

Vibration dampers



76

Mounting parts



34-35

Connectors



36-40

Cutting data



$v_c$  86

Application guide



117

# CoroDrill® 800.24

*The productivity drill*

**Diameter range 25,00 – 65,00 mm**

## **Unique support pad design**

- Indexable economy – two pads in one drill head
- Higher cutting speed – productivity
- Excellent surface finish
- Improves cutting fluid supply

## **Easy to identify**

- Lasermarking of code, dimension and tube range

## **Reliable performance**

- Robust design – high feed per rev. – productivity
- Wear resistant drill body manufactured in hardened steel
- Customer specified diameters
- Close tolerances

## **Excellent hole straightness and surface finish**

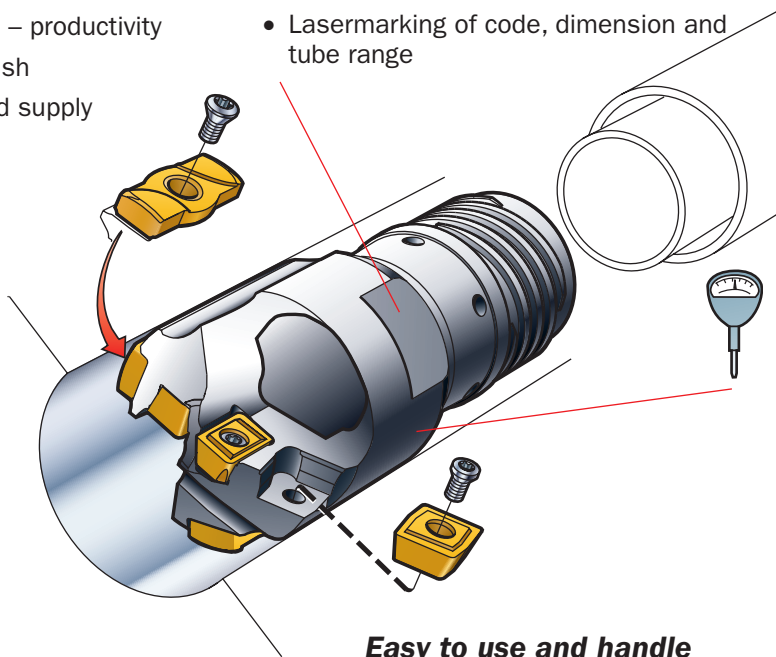

## **Easy to use and handle**

- Fixed insert seats. No pre-setting – no need for tool room services
- Few spare parts – low inventory costs

## **"Coolant accelerator"**

- Patent pending design
- Ensures outstanding chip evacuation
- No chip clogging – no production stops

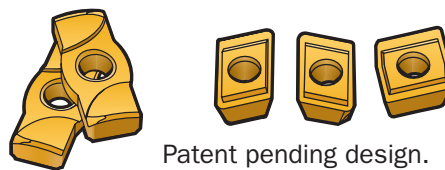
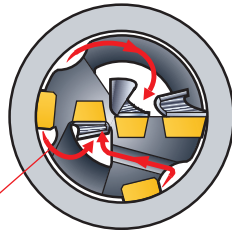

## **Productivity in a wide application range**

- Modern grade and geometry programme cover most work-piece materials
- Few inserts and support pad sizes cover the whole diameter range
- Excellent chip control in both low and high feeds

## CoroDrill® 800.24

- **The most productive choice for diameter range 25,00 – 65,00 mm**
- **Lowest cost per hole**
- **Consistent performance within a wide application area**
- **Standard programme**
- **Developed and manufactured with the latest technology**

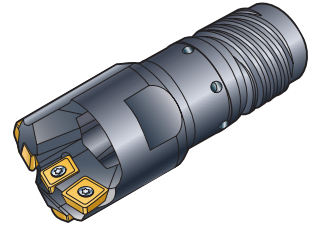

### Preferred Ejector applications

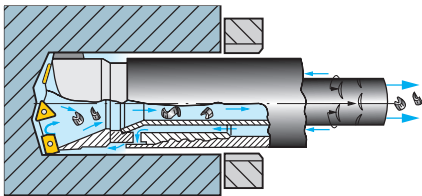

- Modified lathes
- Economical and easy to apply to horizontal boring machines – NC lathes
- Machining centres with horizontal spindle
- Transfer lines
- Easy machining materials

### Typical components – Industry segments

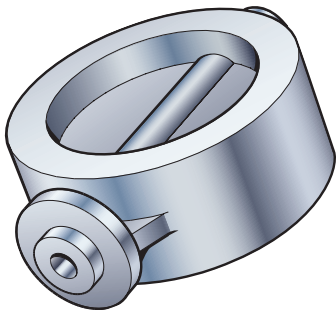

#### Automotive industry

- Axles, piston pins
- Engine block (diesel)
- Hydraulic cylinder
- Track links

#### Process industry

- Oil holes

#### Ship yard

- Coolant/oil holes in engine blocks

#### General engineering workshops

- M/C applications
- Mixed production – short series

#### Throttle valve

Drill dia,  $D_C$  : 30,50 mm

Drill depth,  $l_4$  : 410 mm

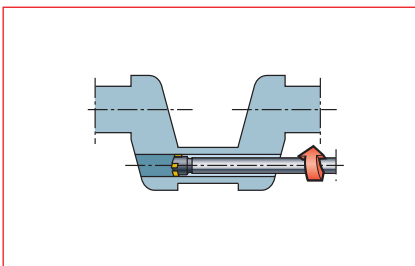

#### Crank shaft

Drill dia,  $D_C$  : 35,00 mm

Drill depth,  $l_4$  : 400 mm

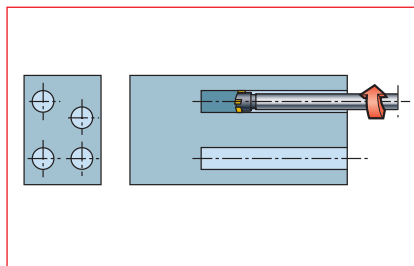

#### Valve body

Drill dia,  $D_C$  : 39,50 mm (x4)

Drill depth,  $l_4$  : 415 mm

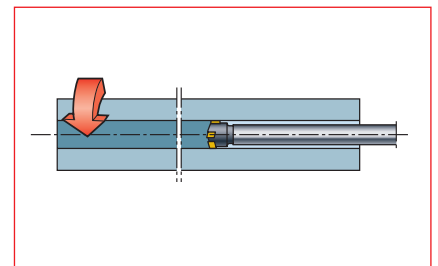

#### Hydraulic cylinder

Drill dia,  $D_C$  : 60,00 mm

Drill depth,  $l_4$  : 1500 mm

## Ejector programme – CoroDrill® solid drill head 800.24

Indexable insert design  
Diameter range  
25,00 – 65,00 mm

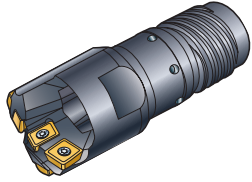

**Diameter range:** 25,00–65,00 mm  
**Hole depth:** 100 × Dia.  
**Hole tolerance:** IT 10  
**Surface finish:**  $R_a$  2 µm  
**Cutting fluid:** Neat oil or soluble with EP-additives

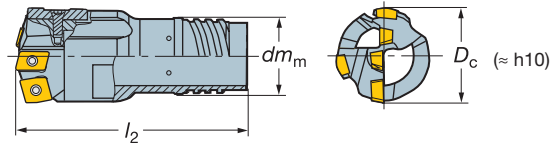

**Note!**  
The drill is manufactured to minus tolerance so that it will not exceed the drill bush diameter, see page 136.

$dm_m$  is the same as  $dm_t$  for the drill tube

Diameter range, mm $D_c$ mm	Tube range	Ordering code, Drill head	Dimensions, mm		Inserts			Support pads	
			$dm_m$	$\leq l_2$	Central	Intermediate	Peripheral	Pad	No.
25,00–26,40	03	800.24-03Dxx.xx	21	75	800-05 03 08M-C-G	800-05 03 08M-I-G	800-06 03 08H-P-G	800-06A	2
26,41–28,70	04	800.24-04Dxx.xx	23,5	78	800-05 03 08M-C-G	800-05 03 08M-I-G	800-06 03 08H-P-G	800-06A	2
28,71–31,00	05	800.24-M05Dxx.xx	25,5	80	800-06 T3 08M-C-G	800-05 03 08M-I-G	800-06 03 08H-P-G	800-06A	2
31,01–33,30	06	800.24-06Dxx.xx	28,0	80,0	800-06 T3 08M-C-G	800-06 T3 08M-I-G	800-08 T3 08H-P-G	800-07A	2
33,31–36,20	07	800.24-07Dxx.xx	30,0	90,0	800-06 T3 08M-C-G <sup>1)</sup> 800-08 T3 08M-C-G <sup>1)</sup>	800-06 T3 08M-I-G <sup>1)</sup> 800-08 T3 08M-I-G <sup>1)</sup>	800-08 T3 08H-P-G	800-07A	2
36,21–39,60	08	800.24-08Dxx.xx	33,0	90,0	800-08 T3 08M-C-G	800-08 T3 08M-I-G	800-08 T3 08H-P-G <sup>1)</sup> 800-09 T3 08H-P-G <sup>1)</sup>	800-07A	2
39,61–43,00	09	800.24-09Dxx.xx	36,0	95,0	800-08 T3 08M-C-G	800-08 T3 08M-I-G	800-09 T3 08H-P-G	800-08A	2
43,01–47,00	10	800.24-10Dxx.xx	39,0	100,0	800-10 T3 08M-C-G	800-08 T3 08M-I-G	800-09 T3 08H-P-G	800-08A	2
47,01–51,70	11	800.24-11Dxx.xx	43,0	110,0	800-12 T3 08M-C-G <sup>1)</sup> 800-10 T3 08M-C-G <sup>1)</sup>	800-08 T3 08M-I-G	800-09 T3 08H-P-G <sup>1)</sup> 800-11 T3 08H-P-G <sup>1)</sup>	800-10A	2
51,71–56,20	12	800.24-12Dxx.xx	47,0	115,0	800-10 T3 08M-C-G	800-08 T3 08M-I-G <sup>1)</sup> 800-12 T3 08M-I-G <sup>1)</sup>	800-11 T3 08H-P-G	800-10A <sup>1)</sup> 800-12A <sup>1)</sup>	2 2
56,21–65,00	13	800.24-13Dxx.xx	51,0	125,0	800-10 T3 08M-C-G <sup>1)</sup> 800-12 T3 08M-C-G <sup>1)</sup>	800-12 T3 08M-I-G	800-11 T3 08H-P-G	800-12A	2

<sup>1)</sup> To match insert/support pad sizes to required drill diameter, see below table.

When ordering drill heads, state drill diameter (xx.xx) in the ordering code.

**Ordering example, drill head: 2 pieces 800.24-03D\*25.00\***

### Drill diameter range – insert and pad sizes

Inserts (Ordered separately)						Support pads (Ordered separately)				
Intermediate and peripheral inserts are also available in L- geometry (for long chipping materials) see page 81.										
Diameter range, mm	Insert	Central	Diameter range, mm	Insert	Intermediate	Diameter range, mm	Insert	Peripheral	Diameter range, mm	Pad
25,00–28,70	05	800-05 03 08M-C-G	25,00–31,00	05	800-05 03 08M-I-G	25,00–31,00	06	800-06 03 08H-P-G	25,00–31,00	800-06A
28,71–33,99	06	800-06 T3 08M-C-G	31,01–34,99	06	800-06 T3 08M-I-G	31,01–38,99	08	800-08 T3 08H-P-G	31,01–39,60	800-07A
34,00–43,00	08	800-08 T3 08M-C-G	35,00–54,99	08	800-08 T3 08M-I-G	39,00–49,99	09	800-09 T3 08H-P-G	39,61–47,00	800-08A
43,01–47,00	10	800-10 T3 08M-C-G	55,00–65,00	12	800-12 T3 08M-I-G	50,00–65,00	11	800-11 T3 08H-P-G	47,01–54,99	800-10A
47,01–49,99	12	800-12 T3 08M-C-G							55,00–65,00	800-12A
50,00–57,99	10	800-10 T3 08M-C-G								
58,00–65,00	12	800-12 T3 08M-C-G								



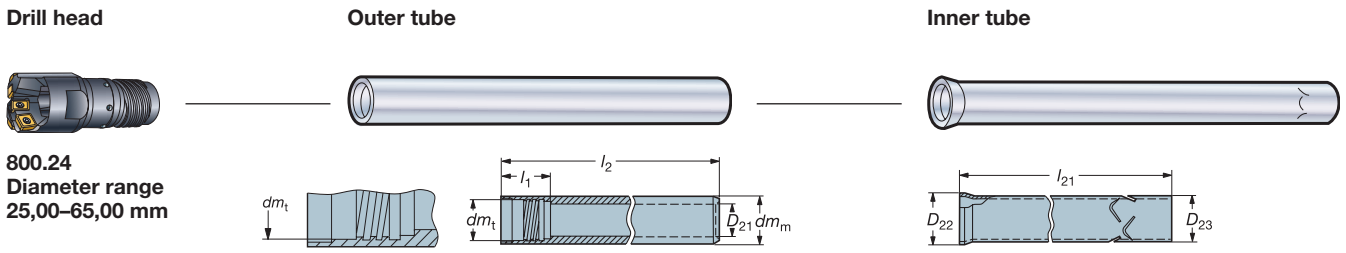

**Note!**  
 Drill tubes are supplied threaded in both ends, with an internal thread, the E-thread.

$dm_t$  is the same as  $dm_m$  for the drill

Diameter range, mm $D_c$ mm	Tube range	Ordering code Outer tube <sup>1)</sup>	Dimensions, mm Standard length $l_2$							Ordering code Inner tube <sup>1)</sup>	Dimensions, mm Standard length $l_{21}$				
			400	630	1070	$dm_m$	$dm_t$	$D_{21}$	$l_1$		430	660	1100	$D_{22}$	$D_{23}$
25,00–26,40	03	424.2-803-	2	3	4	23,5	21	16	30	424.2-853-	2	3	4	16	14
26,41–28,70	04	424.2-804-	2	3	4	26	23,5	18	33	424.2-854-	2	3	4	18	16
28,71–31,00	05	424.2-805-	2	3	4	28	25,5	20	33	424.2-855-	2	3	4	20	18
31,01–33,30	06	424.2-806-	2	3	4	30,5	28	22	33	424.2-856-	2	3	4	22	20
33,31–36,20	07	424.2-807-	2	3	4	33	30	24	40	424.2-857-	2	3	4	24	22
36,21–39,60	08	424.2-808-	2	3	4	35,5	33	26	40	424.2-858-	2	3	4	26	24
39,61–43,00	09	424.2-809-	2	3	4	39	36	29	40	424.2-859-	2	3	4	29	27
43,01–47,00	10	424.2-810-	2	3	4	42,5	39	32	40	424.2-860-	2	3	4	32	30
47,01–51,70	11	424.2-811-	2	3	4	46,5	43	35	44	424.2-861-	2	3	4	35	32
51,71–56,20	12	424.2-812-	2	3	4	51	47	39	44	424.2-862-	2	3	4	39	36
56,21–65,00	13	424.2-813-	2	3	4	55,5	51	43	44	424.2-863-	2	3	4	43	40

<sup>1)</sup> Other lengths can be manufactured by **customer request**, see page 25.

Ordering example for outer tube, length 400 mm and inner tube 430 mm, fitting drill head  $D_c = 25,00$  mm:

**1 piece 424.2-803-2 and 1 piece 424.2-853-2**

**NOTE!**  
 The inner tube must be ordered 30 mm longer than the outer tube.

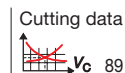
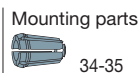
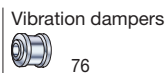

# T-MAX<sup>®</sup> drill 424.10

*The adjustable drill*

**Diameter range 63,50 – 130,00\* mm**

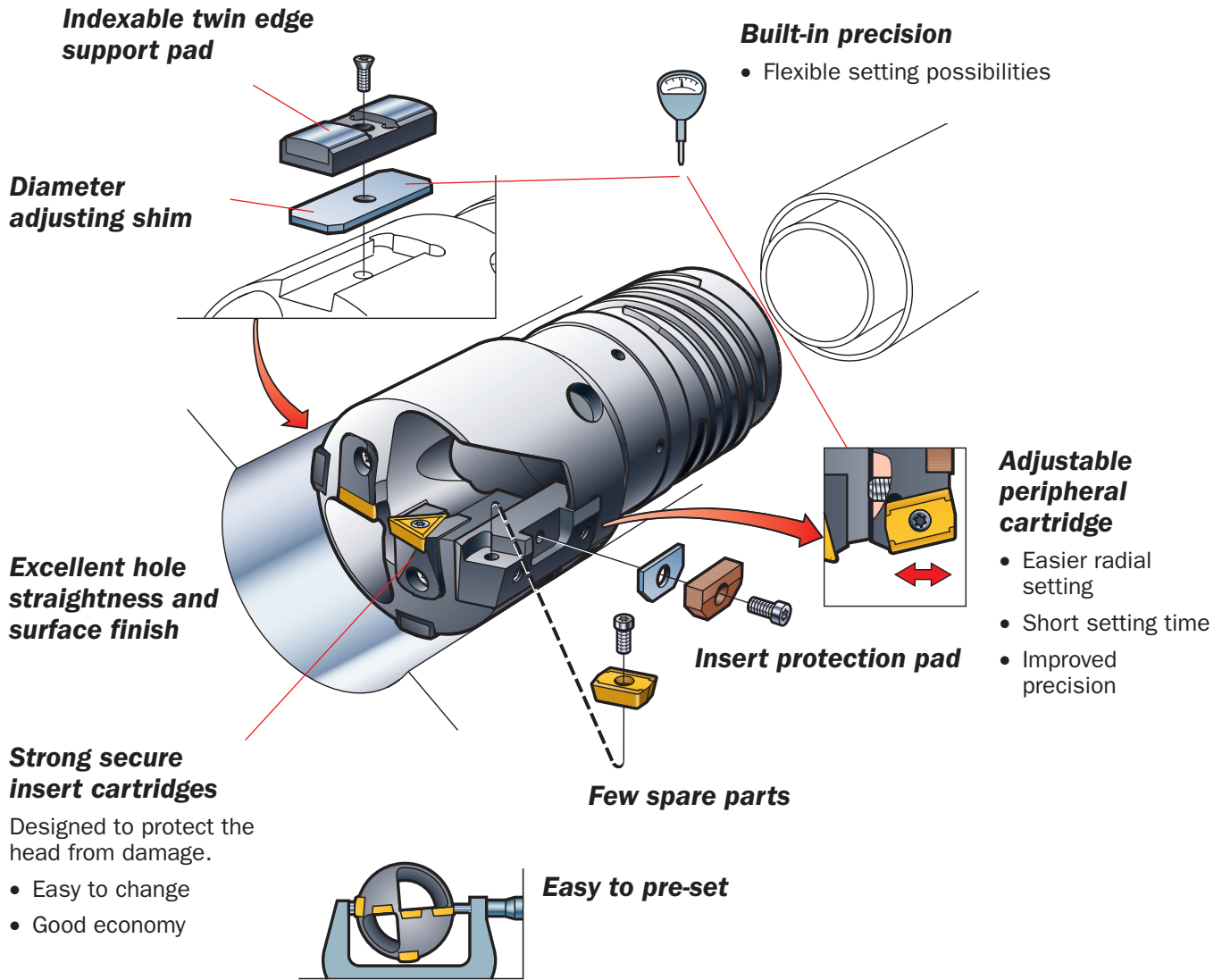

**Strong secure insert cartridges**

Designed to protect the head from damage.

- Easy to change
- Good economy

- Intermediate diameters from 63,50 to 183,99\* mm
- Two thread size options per head size

\*)Larger diameter on request

**Easy to pre-set**

**Modern inserts – machining economy**

- Four insert types cover the whole diameter range
- Geometries and grades for drilling most materials
- Grade GC1025 the best choice for both steel and stainless steel
- High feed rate

**Adjustable peripheral cartridge**

- Easier radial setting
- Short setting time
- Improved precision

**Built-in precision**

- Flexible setting possibilities

## T-MAX<sup>®</sup> drill 424.10

### Setting possibilities on diameter

- Close diameter tolerance and high surface finish
- Good hole straightness in long workpieces
- Wide application area
- High penetration rate in most materials
- Stocked standard programme
- Wide range of engineered solutions

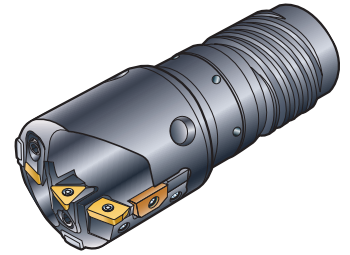

### Preferred Ejector applications

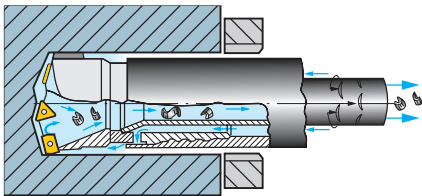

- Modified lathes
- Economical and easy to apply to horizontal boring machines – NC lathes
- Machining centres with tool changer and horizontal spindle
- Transfer lines
- Easy machining materials

### Typical components – Industry segments

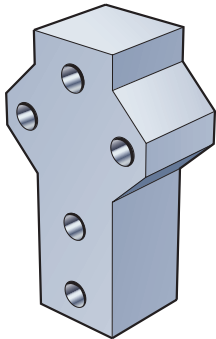

#### Valve body

Drill dia,  $D_C$  : 120,00 mm (x 5)  
Drill depth,  $l_4$  : 549 mm

#### Automotive industry

- Engine block (diesel)

#### Process industry

- Oil holes

#### Aerospace industry

- Landing gear

#### Ship yard

- Coolant/ oil holes in engine blocks

#### General engineering workshops

- Mixed production – short series

#### Defence industry

- Barrels

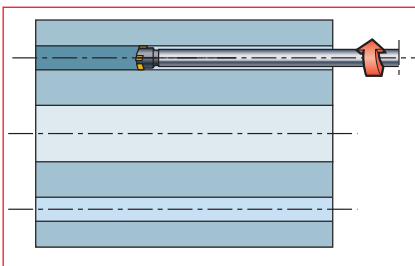

#### Hydroblock

Drill dia,  $D_C$  : 160,00 mm (x 2)  
Drill depth,  $l_4$  : 2000 mm

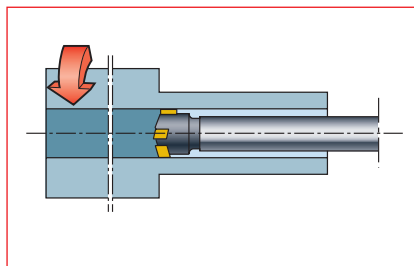

#### Shank

Drill dia,  $D_C$  : 80,00 mm  
Drill depth,  $l_4$  : 3072 mm

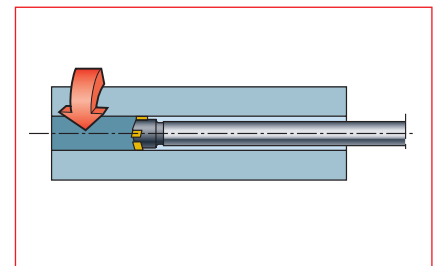

#### Shank

Drill dia,  $D_C$  : 70,00 mm  
Drill depth,  $l_4$  : 1900 mm

# Ejector programme – T-MAX<sup>®</sup> adjustable solid drill head A424.10 / 424.10

Indexable insert design  
Diameter range  
63,50 – 183,90 mm

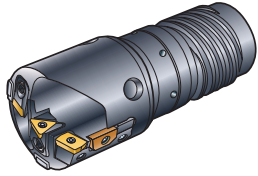

Diameter range: 63,50–183,90 mm  
Hole depth: 100 × Dia.  
Hole tolerance: IT 10  
Surface finish: R<sub>a</sub> 3 μm  
Cutting fluid: Neat oil or soluble with EP-additives

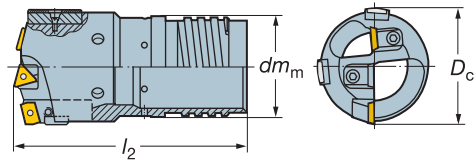

$dm_m$  is the same as  $dm_t$  for the drill tube

Diameter <sup>2)</sup> range, mm	Tube range	Ordering code, Drill head <sup>1)</sup>	Dimensions, mm			Cartridges							
			$dm_m$	$l_2$	Radial <sup>3)</sup> adjustment	Central	No.	Intermediate	No.	Peripheral	No.	Support pad	No.
63,50 65,00	13	A424.10-2500 424.10-0650 E	51	115	+1	L430.31-1216-16	1	R430.30-1216-16	1	R430.28-1516-16	1	430.32-12 D65,0	2
			51	115	+1,5	L430.31-1216-16	1	R430.30-1216-16	1	R430.28-1516-16	1	430.32-12 D65,0	2
65,00	14	424.10-0650	52	150	+1,5	L430.31-1216-16	1	R430.30-1216-16	1	R430.28-1516-16	1	430.32-12 D65,0	2
69,85 70,00 71,45	15	A424.10-2750 424.10-0700 A424.10-2813	58	150	+1	L430.31-1216-16	1	R430.30-1216-16	1	R430.28-1516-16	1	430.32-12 D65,0	2
			58	150	+1	L430.31-1216-16	1	R430.30-1216-16	1	R430.28-1516-16	1	430.32-12 D70,0	2
			58	150	+0,75	L430.31-1216-16	1	R430.30-1216-16	1	R430.28-1516-16	1	430.32-12 D70,0	2
75,00 76,20	16	424.10-0750 A424.10-3000	63	160	+2	L430.31-1216-16	1	R430.30-1216-16	1	R430.28-1822-22	1	430.32-12 D75,0	2
			63	160	+2	L430.31-1216-16	1	R430.30-1216-16	1	R430.28-1822-22	1	430.32-12 D75,0	2
80,00 82,55 85,00	17	424.10-0800 A424.10-3250 424.10-0850	70	190	+1,25	L430.31-1216-16	1	R430.30-1216-16	1	R430.28-1822-22	1	430.32-12 D80,0	2
			70	190	+0,75	L430.31-1216-16	1	R430.30-1216-16	1	R430.28-1822-22	1	430.32-12 D80,0	2
			70	190	+1,75	L430.31-1522-22	1	R430.30-1216-16	1	R430.28-1822-22	1	430.32-12 D85,0	2
88,90 90,00 95,00 95,25	18	A424.10-3500 424.10-0900 424.10-0950 A424.10-3750	77	190	+1,75	L430.31-1522-22	1	R430.30-1216-16	1	R430.28-1822-22	1	430.32-12 D85,0	2
			77	190	+1,75	L430.31-1522-22	1	R430.30-1216-16	1	R430.28-1822-22	1	430.32-12 D90,0	2
			77	190	+2	L430.31-1522-22	1	R430.30-15 22-22	1	R430.28-1822-22	1	430.32-12 D95,0	2
			77	190	+2	L430.31-1522-22	1	R430.30-15 22-22	1	R430.28-1822-22	1	430.32-12 D95,0	2
100,00 101,60 105,00 107,95 110,00	19	424.10-1000 A424.10-4000 424.10-1050 A424.10-4250 424.10-1100	89	195	+1	L430.31-1522-22	1	R430.30-15 22-22	1	R430.28-1822-22	1	430.32-16 D100,0	2
			89	195	+1,25	L430.31-1522-22	1	R430.30-15 22-22	1	R430.28-1822-22	1	430.32-16 D100,0	2
			89	195	+0,5	L430.31-1522-22	1	R430.30-15 22-22	1	R430.28-1822-22	1	430.32-16 D105,0	2
			89	195	+2	L430.31-1216-16	1	R430.30-1216-16	1	R430.28-1516-16	1	430.32-16 D105,0	2
			89	195	+1,5	L430.31-1216-16	1	R430.30-1216-16	1	R430.28-1516-16	1	430.32-16 D110,0	2
114,30 115,00 120,00 120,65	20	A424.10-4500 424.10-1150 424.10-1200 A424.10-4750	101	220	+1,75	L430.31-1216-16	1	R430.30-1216-16	3	R430.28-1516-16	1	430.32-16 D110,0	2
			101	220	+1,5	L430.31-1216-16	1	R430.30-1216-16	3	R430.28-1516-16	1	430.32-16 D115,0	2
			101	220	+1,5	L430.31-1216-16	1	R430.30-1216-16	3	R430.28-1516-16	1	430.32-16 D120,0	2
			101	220	+1,5	L430.31-1216-16	1	R430.30-1216-16	3	R430.28-1822-22	1	430.32-16 D120,0	2
125,00 127,00 130,00	21	424.10-1250 A424.10-5000 424.10-1300	113	220	+1,75	L430.31-1216-16	1	R430.30-1216-16	3	R430.28-1822-22	1	430.32-16 D125,0	2
			113	220	+1,25	L430.31-1216-16	1	R430.30-1216-16	3	R430.28-1822-22	1	430.32-16 D125,0	2
			113	220	+0,5	L430.31-1216-16	1	R430.30-1216-16	3	R430.28-1822-22	1	430.32-16 D130,0	2
136,00-147,90	22	Tailor Made											
148,00-159,90	23	Tailor Made											
160,00-171,90	24	Tailor Made											
172,00-183,90	25	Tailor Made											

1) "A" in the ordering code indicates drill with inch dimensions.

2) Drills in other dimensions are available on request.

3) For radial adjustment, see page 78.

Ordering example, complete drill head: 2 pieces 424.10-0650E

For Ordering additional cartridge/support pad:  
2 pieces L430.31-1216-16  
4 pieces 430.32-12 D65,0

Inserts (Ordered separately)								
Central cartridge	△	Insert	Intermediate cartridge	△	Insert	Peripheral cartridge	△	Insert
L430.31-1216-16	16	TPMT 16T312R-22	R430.30-1216-16	16	TPMT 16T312R-22	R430.28-1516-16	13	R424.9-13T308-22
	16	TPMT 16T312TR-23		16	TPMT 16T312TR-23		13	R424.9-13T308-23
L430.31-1522-22	22	TPMT 220612R-22	R430.30-1522-22	22	TPMT 220612R-22	R430.28-1822-22	18	R424.9-180608-22
	22	TPMT 220612TR-23		22	TPMT 220612TR-23		18	R424.9-180608-23



**Drill head**



**A424.10 / 424.10**  
**Diameter range**  
**63,50–183,90 mm**

**Outer tube, range 13–25**

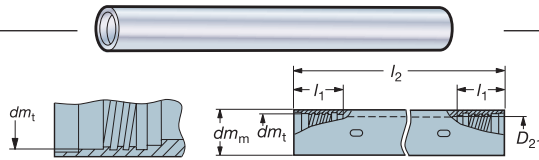

**Inner tube, range 13**

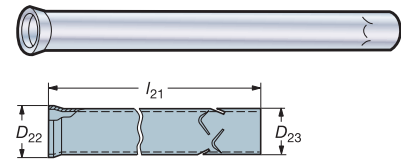

**Inner tube, range 14–25**

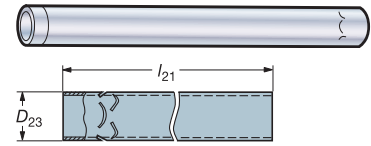

**Note!**  
 Drill tubes are supplied threaded in both ends,  
 with an internal thread, the E-thread.

$dm_t$  is the same as  $dm_m$  for the drill

Diameter range, mm $D_c$ mm	Tube range	Ordering code Outer tube <sup>1)</sup>	Dimensions, mm						Ordering code Inner tube <sup>1)</sup>	Dimensions, mm					
			Standard length $l_2$			$dm_m$	$dm_t$	$D_{21}$		$l_1$	Standard length $l_{21}$			$D_{22}$	$D_{23}$
			400	630	1070						430	660	1100		
63,50 65,00	13	424.2-813- 424.2-813-	2	3	4	55,5	51	43	44	424.2-863- 424.2-863-	2	3	4	43	40
65,00	14	424.2-814-L <sup>1)</sup>	-	-	-	56	52	43	75	424.2-864-L <sup>1)</sup>	-	-	-	-	40
69,85 70,00 71,45	15	424.2-815-L <sup>1)</sup>	-	-	-	62	58	48	75	424.2-865-L <sup>1)</sup>	-	-	-	-	44
75,00 76,20	16	424.2-816-L <sup>1)</sup>	-	-	-	68	63	53	75	424.2-866-L <sup>1)</sup>	-	-	-	-	48
80,00 82,55 85,00	17	424.2-817-L <sup>1)</sup>	-	-	-	75	70	59	97	424.2-867-L <sup>1)</sup>	-	-	-	-	54
88,90 90,00 95,00 95,25	18	424.2-818-L <sup>1)</sup>	-	-	-	82	77	66	97	424.2-868-L <sup>1)</sup>	-	-	-	-	60
100,00 101,60 105,00 107,95 110,00	19	424.2-819-L <sup>1)</sup>	-	-	-	94	89	78	97	424.2-869-L <sup>1)</sup>	-	-	-	-	70
114,30 115,00 120,00 120,65	20	424.2-820-L <sup>1)</sup>	-	-	-	106	101	90	118	424.2-870-L <sup>1)</sup>	-	-	-	-	80
125,00 127,00 130,00	21	424.2-821-L <sup>1)</sup>	-	-	-	118	113	92	118	424.2-871-L <sup>1)</sup>	-	-	-	-	80
136,00–147,90	22	424.2-822-L <sup>1)</sup>	-	-	-	130	125	104	118	424.2-872-L <sup>1)</sup>	-	-	-	-	95
148,00–159,90	23	424.2-823-L <sup>1)</sup>	-	-	-	142	137	116	139	424.2-873-L <sup>1)</sup>	-	-	-	-	100
160,00–171,90	24	424.2-824-L <sup>1)</sup>	-	-	-	154	149	128	139	424.2-874-L <sup>1)</sup>	-	-	-	-	120
172,00–183,90	25	424.2-825-L <sup>1)</sup>	-	-	-	166	161	140	139	424.2-875-L <sup>1)</sup>	-	-	-	-	130

<sup>1)</sup> Lengths are manufactured by **customer request**, see page 25.

Ordering example for outer tube, length 400 mm and inner tube 430 mm,  
 fitting drill head  $D_c = 63,50$  mm:

**1 piece 424.2-813-2 and 1 piece 424.2-863-2**

**Note!**

Inner tube 424.2 for drilling diameter 65,00–123,90 mm must be ordered 190 mm longer than the outer tube.

Inner tube 424.2 for drilling diameter 124,00–183,90 mm must be ordered 220 mm longer than the outer tube.

See page 35 for connecting sleeve:

- Normal type
- Reinforced type A (available on request)

Ordering example for drill tube, design to customer request,  
 outer tube length 3000 mm and inner tube 3190 mm,  
 fitting drill head  $D_c = 65,00$  mm:

**1 piece 424.2-814-L3000 and 1 piece 424.2-864-L3190**

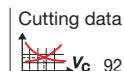
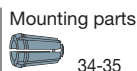



- Quick quotation
- Easy to order
- Competitive delivery

**Even more possibilities thanks to tailored design!**  
 If you do not find what you need in our comprehensive standard programme, choose the tool shape you require and we will tailor it for you to *your* dimensions.

**T-Max® adjustable solid drill head 424.10**

**$D_c = 63,50 - 183,99$  mm, with E-thread**

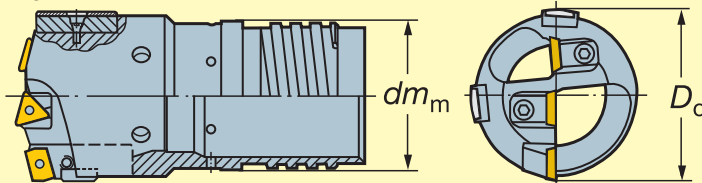

$D_c$	$dm_m$	E-thread range <sup>1)</sup>
63,50- 64,99	51	13
65,00- 66,99	51 / 52	13 / 14
67,00- 72,99	52 / 58	14 / 15
73,00- 79,99	58 / 63	15 / 16
80,00- 86,99	63 / 70	16 / 17
87,00- 99,99	70 / 77	17 / 18
100,00-111,99	77 / 89	18 / 19
112,00-123,99	89 / 101	19 / 20
124,00-135,99	101 / 113	20 / 21
136,00-147,99	113 / 125	21 / 22
148,00-159,99	125 / 137	22 / 23
160,00-171,99	137 / 149	23 / 24
172,00-183,99	149 / 161	24 / 25

<sup>1)</sup> Compare with drill tube  
 (424.2 – 8xx Ejector / 420.5 – 8xx STS)

**Options**

**Note** For specific details regarding the options, contact your Sandvik Coromant sales representative.

$D_c$  Diameter – **63,50–183,90** mm  
 $dm_m$  Thread size – **51–161**

**Drill tubes manufactured by customer request**

**Note!** For specific details regarding the options, contact your Coromant sales representative.

Drill head	Tube range	Outer tube Dimensions, mm Length to customer request $l_2$ (Min – Max)	Tube range	Inner tube Dimensions, mm Length to customer request $l_{21}$ (Min – Max)	For drawings and complementary dimensions, see page:
424.6	03 – 13	220 – 5300	00 – 13	300 – 5500	15
800.24	00 – 13	220 – 5300	00 – 13	300 – 5500	19
424.10	13 14 – 18 19 – 25	220 – 5300 220 – 5000 220 – 3000	13 – 25	300 – 5500	23
424.31F	00 – 09	220 – 5300	00 – 09	300 – 5500	29
424.31F	10 – 13 14 – 18	220 – 5300 220 – 5000	10 – 21	300 – 5500	31
424.31	14 – 18 19 – 25	220 – 5000 220 – 3000	14 – 25	300 – 5500	33

**Note:**  
The inner tube must always be ordered 30 mm longer than the outer tube.

Ordering example for drill tube, design to customer request, outer tube length 800 mm and inner tube 830 mm, fitting drill head  $D_c = 29,50$  mm:

**1 piece 424.2-805-L800 and 1 piece 424.2-855-L830**

### Calculation of special length tubes – Ejector system

For solid drill heads 424.6, 800.24 and 424.10

$l_{24}$  = End of drill tube to tip of central Insert  
 $l_{23}$  = End of drill tube to tip of peripheral insert  
 $l_{21}$  = Hole depth  
 $l_{22}$  = Minimum bushing length  
 $l_c$  = Length of drill tube in connector  
 $l_2$  = Tube Length =  $l_{21} + l_{22} + l_c - l_{24}$   
 (for brazed ejector drills)

Diameter range, mm				Diameter range, mm			
$D_c$ mm	$l_{24}$	$l_{23}$	$l_{22}$ min	$D_c$ mm	$l_{24}$	$l_{23}$	$l_{22}$ min
18,40-20,00	22,5	19,6	28	33,31-36,20	30,5	26	36
20,01-21,80	26	22,9	31	36,21-39,60	33,5	28,7	39
21,81-24,10	26	22,8	31	39,61-43,00	33,5	28,2	39
24,11-26,40	27,5	24	33	43,01-47,00	35	29,5	40
26,41-28,70	27,5	23,8	33	47,01-51,70	35	28,8	40
28,71-31,00	30,5	26,5	36	51,71-56,20	38	31,5	43
31,01-33,30	30,5	26,4	36	56,21-65,00	40	33,2	45

Diameter range, mm				Diameter range, mm			
$D_c$ mm	$l_{24}$	$l_{23}$	$l_{22}$ min	$D_c$ mm	$l_{24}$	$l_{23}$	$l_{22}$ min
25,00-26,40	45	42	50	43,01-47,00	60	54	65
26,41-28,70	45	42	50	47,01-51,70	66	59	71
28,71-31,00	47	43	52	51,71-56,20	71	63,5	76
31,01-33,30	47	42,5	52	56,21-65,00	81	72	86
33,31-36,20	50	45	55				
36,21-39,60	50	45	55				
39,61-43,00	55	49	60				

Diameter range, mm			Diameter range, mm		
$D_c$ mm	$l_{24}$	$l_{22}$ min	$D_c$ mm	$l_{24}$	$l_{22}$ min
63,5- 65,0	71	76	112,0-123,9	77	82
65,0- 66,9	75	80	124,0-135,9	102	107
67,0- 72,9	75	80	136,0-147,9	112	117
73,0- 79,9	85	90			
80,0- 86,9	93	98			
87,0- 99,9	93	98			
100,0-111,9	98	103			

	$l_c$
424.2-400M 424.9S/170-1 and 424.2-410	120
424.2-401M 424.9S/231-1 and 424.2-411	103

# T-MAX<sup>®</sup> 424.31F and 424.31 counterboring heads

*The productivity and precision single insert counterboring heads*

**Diameter range 20,00- 183,90 mm**

### Strong cartridges

Designed to protect from damage.

- Easy to change
- Good economy

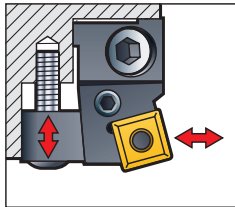

### Built-in precision

- Radial adjustment

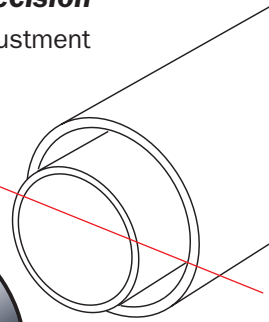

### Adjustable peripheral cartridge

- Easier radial setting
- Short setting time
- Improved precision

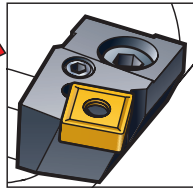

**Excellent hole straightness and surface finish**

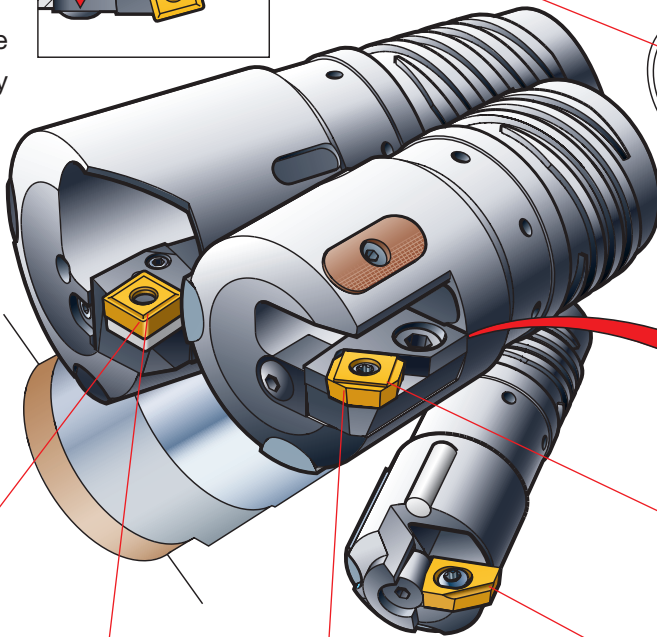

### Precision

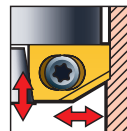

**424.31F**  
Dia. range  
**20,00–43,00 mm**  
 $a_p = 3 \text{ mm}$   
Tol. IT9

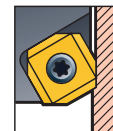

**424.31F**  
Dia. range  
**43,01–124,99 mm**  
 $a_p = 4,5 \text{ mm}$   
Tol. IT9

### Productivity



**424.31**  
TPxx insert  
Dia. range  
**65,00–183,90 mm**  
 $a_p = 12–17 \text{ mm}$   
Tol. IT10

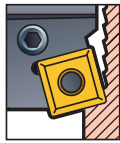

**424.31**  
SNxx insert  
Dia. range  
**65,00–183,90 mm**  
 $a_p = 10–16 \text{ mm}$   
Tol. IT10

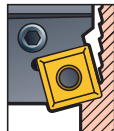

**424.31F**  
SNxx insert  
Dia. range  
**43,01–124,99 mm**  
 $a_p = 6 \text{ mm}$   
Tol. IT10

### Machining economy

- Insert grades for counterboring in most materials.
- Insert types, sizes and geometries to get higher productivity, closer hole tolerances and higher surface finish.

### Note!

For applications requiring radial cut depths above 17 mm we recommend 424.32, see page 71.



# T-MAX<sup>®</sup> 424.31F and 424.31 counterboring heads

*Designed for precision, productivity and versatility*

- **Stocked standard components**
- **A complement to solid drilling**
  - for final diameter and surface finish operations
  - to extend hole diameter when machine power is limited.

*The same tube can normally be used*
- **Wide range of engineered solutions**

424.31F

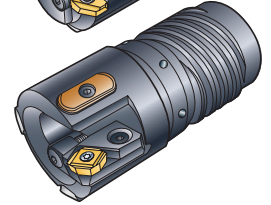
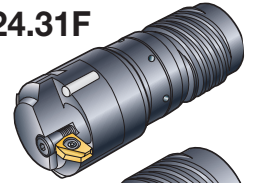

424.31

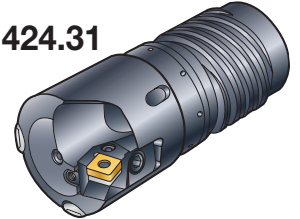

## Preferred Ejector applications

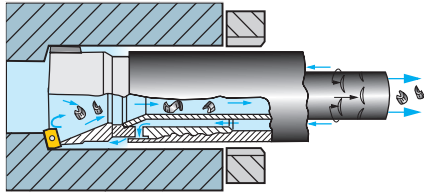

- Modified lathes
- Economical and easy to apply to horizontal boring machines - NC lathes.

- Machining centres with tool changer and horizontal spindle
- Transfer lines
- Easy machining materials

## Typical components – Industry segments

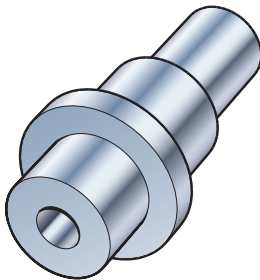

### Process industry

- Oil holes

### Aerospace industry

- Landing gears

### Ship yard

- Coolant/oil holes in engine blocks

### General engineering workshops

- Mixed production – short series

### Defence industry

- Barrels

### Rotor shaft

Bore dia,  $D_C$  : 73,00 mm (61,20 mm)

Drill depth,  $l_4$  : 550 mm

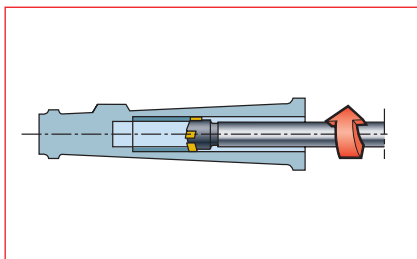

### Fork leg

Bore dia,  $D_C$  : 35,00 mm (30,00 mm)

Drill depth,  $l_4$  : 305 mm

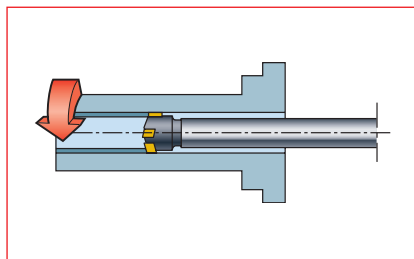

### Lathe spindle

Bore dia,  $D_C$  : 90,50 mm (61,20 mm)

Drill depth,  $l_4$  : 914 mm

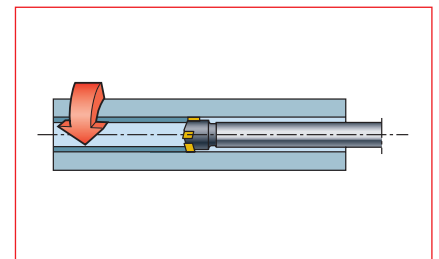

### Hollow bar

Bore dia,  $D_C$  : 40,00 mm (35,00 mm)

Drill depth,  $l_4$  : 373,00 mm

**T-MAX® counterboring head 424.31F – manufactured by customer request**  
**Single indexable insert design – close tolerance**  
**Diameter range 20,00 – 43,00 mm**

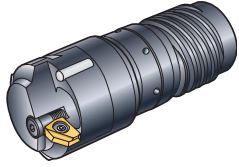

**Diameter range:** 20,00–43,00 mm  
**Hole depth:** 100 × diameter  
**Hole tolerance:** IT 9  
**Surface finish:**  $R_a$  1  $\mu$ m  
**Cutting fluid:** Neat oil or emulsion with EP-additives

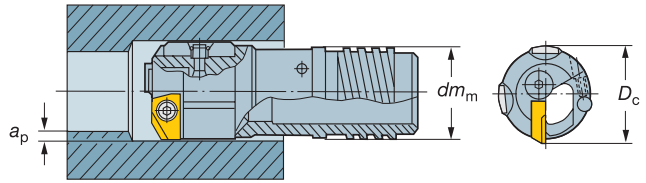

$dm_m$  is the same as  $dm_t$  for the drill tube

Diameter range, mm	Max. cutting depth	Inserts <sup>1)</sup>	Support pad set	Pressure pad set
$D_c$ mm	$a_p$ mm	R424.31F 	No.	No.
20,00–22,99	3,0	04	430.21 -06 D20,0 2	5636 010-011 1
23,00–25,99	3,0	04	430.21 -06 D23,0 2	5636 010-011 1
26,00–31,00	3,0	04	430.21 -06 D26,0 2	5636 010-011 1
31,01–33,99	3,0	04	430.21 -08 D31,0 2	5636 010-021 1
34,00–37,99	3,0	04	430.21 -08 D34,0 2	5636 010-021 1
38,00–43,00	3,0	04	430.21 -08 D38,0 2	5636 010-021 1

<sup>1)</sup> Inserts are ordered separately.

Ordering example: 2 pieces 430.21-06 D20,0

**Ordering**

When ordering counterboring heads the following must be stated:

- Drill diameter,  $D_c$ .
- Depth of cut or pre-bored size.
- Cartridges to be used – cartridge for close tolerances or for normal tolerances.
- Drilling system to be used – Ejector or STS.
- Drill tubes to be used and size  $dm_t$ .

**For more information and advice, please contact your nearest Sandvik representative.**



Counterboring head

Outer tube

Inner tube

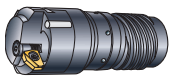

424.31F  
Diameter range  
20,00–43,00 mm

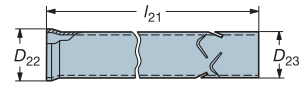
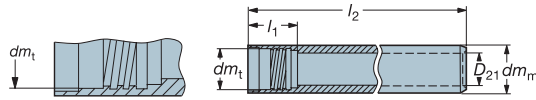

**Note!**  
Drill tubes are supplied threaded in both ends,  
with an internal thread, the E-thread.

$dm_t$  is the same as  $dm_m$  for the drill

Diameter range, mm  $D_c$ mm	Tube range	Ordering code Outer tube <sup>1)</sup>	Dimensions, mm						Ordering code Inner tube <sup>1)</sup>	Dimensions, mm					
			Standard length $l_2$			$dm_m$	$dm_t$	$D_{21}$		$l_1$	Standard length $l_{21}$			$D_{22}$	$D_{23}$
			400	630	1070						430	660	1100		
20,00-22,99	00	424.2-800-	2	3	4	18	16	12	27,5	424.2-850-	2	3	4	12	10
	01	424.2-801-	2	3	4	19,5	18	14	30	424.2-851-	2	3	4	14	12
	02	424.2-802-	2	3	4	21,5	19,5	15	30	424.2-852-	2	3	4	15	13
23,00-25,99	02	424.2-802-	2	3	4	21,5	19,5	15	30	424.2-852-	2	3	4	15	13
	03	424.2-803-	2	3	4	23,5	21	16	30	424.2-853-	2	3	4	16	14
26,00-31,00	03	424.2-803-	2	3	4	23,5	21	16	30	424.2-853-	2	3	4	16	14
	04	424.2-804-	2	3	4	26	23,5	18	33	424.2-854-	2	3	4	18	16
	05	424.2-805-	2	3	4	28	25,5	20	33	424.2-855-	2	3	4	20	18
31,01-33,99	06	424.2-806-	2	3	4	30,5	28	22	33	424.2-856-	2	3	4	22	20
	07	424.2-807-	2	3	4	33	30	24	40	424.2-857-	2	3	4	24	22
34,00-37,99	07	424.2-807-	2	3	4	33	30	24	40	424.2-857-	2	3	4	24	22
	08	424.2-808-	2	3	4	35,5	33	26	40	424.2-858-	2	3	4	26	24
38,00-43,00	08	424.2-808-	2	3	4	35,5	33	26	40	424.2-858-	2	3	4	26	24
	09	424.2-809-	2	3	4	39	36	29	40	424.2-859-	2	3	4	29	27

<sup>1)</sup> Other lengths can be manufactured by customer request, see page 25.

Ordering example for outer tube length 400 mm and inner tube 430 mm fitting drill head  $D_c = 20,00$  mm:

**1 piece 424.2-800-2 and 1 piece 424.2-850-2**

**NOTE!**

The inner tube must be ordered 30 mm longer than the outer tube.

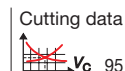
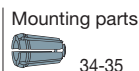

**T-MAX® counterboring head 424.31F – manufactured by customer request**  
 Single indexable insert design – close and normal tolerances  
 Diameter range 43,01 – 124,99 mm

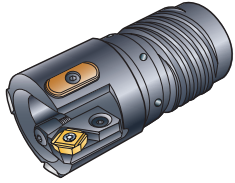

**Diameter range:** 43,01–124,99 mm  
**Hole depth:** 100 × diameter  
**Hole tolerance:** IT 9 or IT 10  
**Surface finish:**  $R_a$  1  $\mu$ m  
**Cutting fluid:** Neat oil or emulsion with EP-additives

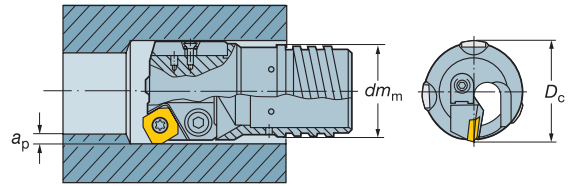

$dm_m$  is the same as  $dm_t$  for the drill tube

Diameter range, mm	Cartridge	Max. cutting depth	Inserts <sup>1)</sup>		Max. cutting depth	Inserts <sup>1)</sup>		Support pad set	Pressure pad set	
			R424.31F			SNMG SNMM			No.	No.
$D_c$ mm	For close tolerances (IT9)	$a_p$ mm			For normal tolerances (IT10)	$a_p$ mm				
43,01– 46,99	R430.24-1118-06	4,5	06		R430.24-1018-09	6,0	09		430.21-10 D43,0	2 5636 020-011 1
47,00– 51,99	R430.24-1118-06	4,5	06		R430.24-1018-09	6,0	09		430.21-10 D47,0	2 5636 020-011 1
52,00– 57,99	R430.24-1118-06	4,5	06		R430.24-1018-09	6,0	09		430.21-10 D52,0	2 5636 020-011 1
58,00– 65,00	R430.24-1118-06	4,5	06		R430.24-1018-09	6,0	09		430.21-10 D58,0	2 5636 020-011 1
65,00– 69,99	R430.24-1118-06	4,5	06		R430.24-1018-09	6,0	09		430.21-12 D65,0	2 420.37-410-01 3
70,00– 74,99	R430.24-1118-06	4,5	06		R430.24-1018-09	6,0	09		430.21-12 D70,0	2 420.37-410-01 3
75,00– 79,99	R430.24-1118-06	4,5	06		R430.24-1018-09	6,0	09		430.21-12 D75,0	2 420.37-410-01 3
80,00– 84,99	R430.24-1118-06	4,5	06		R430.24-1018-09	6,0	09		430.21-12 D80,0	2 420.37-415-01 3
85,00– 89,99	R430.24-1118-06	4,5	06		R430.24-1018-09	6,0	09		430.21-12 D85,0	2 420.37-415-01 3
90,00– 94,99	R430.24-1118-06	4,5	06		R430.24-1018-09	6,0	09		430.21-16 D90,0	2 420.37-510-01 3
95,00– 99,99	R430.24-1118-06	4,5	06		R430.24-1018-09	6,0	09		430.21-16 D95,0	2 420.37-510-01 3
100,00–104,99	R430.24-1118-06	4,5	06		R430.24-1018-09	6,0	09		430.21-16 D100,0	2 420.37-510-01 3
105,00–109,99	R430.24-1118-06	4,5	06		R430.24-1018-09	6,0	09		430.21-16 D105,0	2 420.37-510-01 3
110,00–114,99	R430.24-1118-06	4,5	06		R430.24-1018-09	6,0	09		430.21-16 D110,0	2 420.37-510-01 3
115,00–119,99	R430.24-1118-06	4,5	06		R430.24-1018-09	6,0	09		430.21-16 D115,0	2 420.37-510-01 3
120,00–124,99	R430.24-1118-06	4,5	06		R430.24-1018-09	6,0	09		430.21-16 D120,0	2 420.37-510-01 3

<sup>1)</sup> Inserts are ordered separately.

Ordering example: 2 pieces R430.24-1118-06

**Ordering**

When ordering counterboring heads the following must be stated:

- Drill diameter,  $D_c$ .
- Depth of cut or pre-bored size.
- Cartridges to be used – cartridge for close tolerances or for normal tolerances.
- Drilling system to be used – Ejector or STS.
- Drill tubes to be used and size  $dm_t$ .

For more information and advice, please contact your nearest Sandvik representative.



Counterboring head



424.31F  
Diameter range  
43,01-124,99 mm

Outer tube, range 10-21

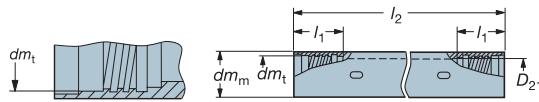

Inner tube, range 10-13

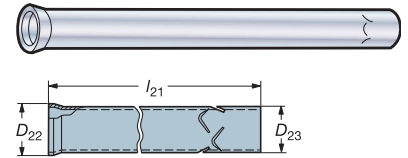

Inner tube, range 14-21

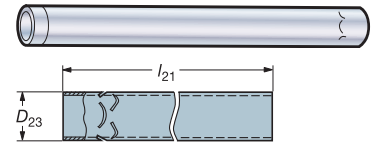

**Note!**  
Drill tubes are supplied threaded in both ends,  
with an internal thread, the E-thread.

$dm_t$  is the same as  $dm_m$  for the drill

Diameter range, mm	Tube range	Ordering code Outer tube <sup>1)</sup>	Dimensions, mm							Ordering code Inner tube <sup>1)</sup>	Dimensions, mm				
			Standard length $l_2$				$dm_m$	$dm_t$	$D_{21}$		$l_1$	Standard length $l_{21}$			
			400	630	1070							430	660	1100	$D_{22}$
$D_c$ mm															
43,01-46,99	10	424.2-810-	2	3	4	42,5	39	32	40	424.2-860-	2	3	4	32	30
47,00-51,99	11	424.2-811-	2	3	4	46,5	43	35	44	424.2-861-	2	3	4	35	32
	12	424.2-812-	2	3	4						51	47	39		
52,00-57,99	12	424.2-812-	2	3	4	51	47	39	44	424.2-862-	2	3	4	39	36
	13	424.2-813-	2	3	4						55,5	51	43		
58,00-65,00	13	424.2-813-	2	3	4	55,5	51	43	44	424.2-863-	2	3	4	43	40
65,00-69,99	14	424.2-814-L <sup>1)</sup>	-	-	-	62	58	48	75	424.2-864-L <sup>1)</sup>	-	-	-	-	40
70,00-74,99	15	424.2-815-L <sup>1)</sup>	-	-	-	62	58	48	75	424.2-865-L <sup>1)</sup>	-	-	-	-	44
	16	424.2-816-L <sup>1)</sup>	-	-	-						68	63	53	75	424.2-866-L <sup>1)</sup>
75,00-79,99	16	424.2-816-L <sup>1)</sup>	-	-	-	68	63	53	75	424.2-866-L <sup>1)</sup>	-	-	-	-	48
80,00-84,99	17	424.2-817-L <sup>1)</sup>	-	-	-	75	70	59	97	424.2-867-L <sup>1)</sup>	-	-	-	-	54
85,00-89,99	17	424.2-817-L <sup>1)</sup>	-	-	-	75	70	59	97	424.2-867-L <sup>1)</sup>	-	-	-	-	54
	18	424.2-818-L <sup>1)</sup>	-	-	-						82	77	86	97	424.2-868-L <sup>1)</sup>
90,00-94,99	18	424.2-818-L <sup>1)</sup>	-	-	-	82	77	86	97	424.2-868-L <sup>1)</sup>	-	-	-	-	60
	18	424.2-818-L <sup>1)</sup>	-	-	-						82	77	86	97	424.2-868-L <sup>1)</sup>
100,00-104,99	19	424.2-819-L <sup>1)</sup>	-	-	-	94	89	78	97	424.2-869-L <sup>1)</sup>	-	-	-	-	70
105,00-109,99	19	424.2-819-L <sup>1)</sup>	-	-	-	94	89	78	97	424.2-869-L <sup>1)</sup>	-	-	-	-	70
110,00-114,99	19	424.2-819-L <sup>1)</sup>	-	-	-	94	89	78	97	424.2-869-L <sup>1)</sup>	-	-	-	-	70
	20	424.2-820-L <sup>1)</sup>	-	-	-						106	101	90	118	424.2-870-L <sup>1)</sup>
115,00-119,99	20	424.2-820-L <sup>1)</sup>	-	-	-	106	101	90	118	424.2-870-L <sup>1)</sup>	-	-	-	-	80
	20	424.2-821-L <sup>1)</sup>	-	-	-						118	113	92	118	424.2-871-L <sup>1)</sup>

<sup>1)</sup> Lengths are manufactured by customer request, see page 25.

Ordering example for outer tube length 400 mm and inner tube 430 mm fitting drill head  $D_c = 43,01$  mm:

**1 piece 424.2-810-2 and 1 piece 424.2-860-2**

Ordering example for drill tube, design to customer request, outer tube length 800 mm and inner tube 830 mm, fitting drill head  $D_c = 65,01$  mm:

**1 piece 424.2-814-L800 and 1 piece 424.2-864-L830**

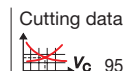
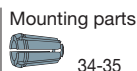



**T-MAX® counterboring head 424.31 – manufactured by customer request**

Single indexable insert design  
Diameter range ≥ 65,00 mm

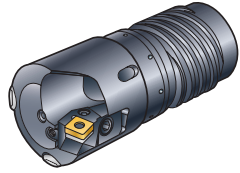

**Diameter range:** 65,00 – Max dia is dependent on machine capacity  
**Hole depth:** 100 × diameter  
**Hole tolerance:** IT 10  
**Surface finish:** R<sub>a</sub> 3 μm  
**Cutting fluid:** Neat oil or soluble with EP-additives

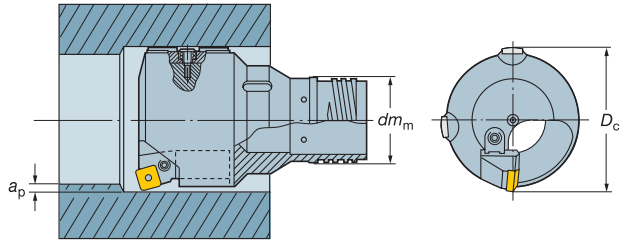

$dm_m$  is the same as  $dm_t$  for the drill tube

Diameter range, mm $D_C$ mm	T-Max P cartridge	Max. cutting depth $a_p$ mm	Inserts (Ordered separately)	T-Max S cartridge	Max. cutting depth $a_p$ mm	Inserts (Ordered separately)	Support pad set No.
			SNMG SNMM 			TPMX TPUN <sup>2)</sup> 	
65,00– 69,99	R430.24-2024-12	10	12	R430.23-2024-16	12	16	430.21-12 D65,0 2
70,00– 74,99	R430.24-2024-12	10	12	R430.23-2024-16	12	16	430.21-12 D70,0 2
75,00– 79,99	R430.24-2024-12	10	12	R430.23-2024-16	12	16	430.21-12 D75,0 2
80,00– 84,99	R430.24-2024-12	10	12	R430.23-2024-16	12	16	430.21-12 D80,0 2
85,00– 89,99	R430.24-2024-12	10	12	R430.23-2024-16	12	16	430.21-12 D85,0 2
90,00– 94,99	R430.24-2532-19 <sup>1)</sup>	16	19	R430.23-2532-22 <sup>1)</sup>	17	22	430.21-16 D90,0 2
95,00– 99,99	R430.24-2532-19 <sup>1)</sup>	16	19	R430.23-2532-22 <sup>1)</sup>	17	22	430.21-16 D95,0 2
100,00–104,99	R430.24-2532-19 <sup>1)</sup>	16	19	R430.23-2532-22 <sup>1)</sup>	17	22	430.21-16 D100,0 2
105,00–109,99	R430.24-2532-19 <sup>1)</sup>	16	19	R430.23-2532-22 <sup>1)</sup>	17	22	430.21-16 D105,0 2
110,00–114,99	R430.24-2532-19 <sup>1)</sup>	16	19	R430.23-2532-22 <sup>1)</sup>	17	22	430.21-18 D110,0 2
115,00–119,99	R430.24-2532-19 <sup>1)</sup>	16	19	R430.23-2532-22 <sup>1)</sup>	17	22	430.21-18 D115,0 2
120,00–124,99	R430.24-2532-19 <sup>1)</sup>	16	19	R430.23-2532-22 <sup>1)</sup>	17	22	430.21-18 D120,0 2
125,00–129,99	R430.24-2532-19 <sup>1)</sup>	16	19	R430.23-2532-22 <sup>1)</sup>	17	22	430.21-18 D125,0 2
130,00–139,99	R430.24-2532-19 <sup>1)</sup>	16	19	R430.23-2532-22 <sup>1)</sup>	17	22	430.21-18 D130,0 2
140,00–149,99	R430.24-2532-19 <sup>1)</sup>	16	19	R430.23-2532-22 <sup>1)</sup>	17	22	430.21-18 D140,0 2
150,00–159,99	R430.24-2532-19 <sup>1)</sup>	16	19	R430.23-2532-22 <sup>1)</sup>	17	22	430.21-18 D150,0 2
160,00–169,99	R430.24-2532-19 <sup>1)</sup>	16	19	R430.23-2532-22 <sup>1)</sup>	17	22	430.21-18 D160,0 2
170,00–179,99	R430.24-2532-19 <sup>1)</sup>	16	19	R430.23-2532-22 <sup>1)</sup>	17	22	430.21-18 D170,0 2
180,00–183,90	R430.24-2532-19 <sup>1)</sup>	16	19	R430.23-2532-22 <sup>1)</sup>	17	22	430.21-18 D180,0 2

<sup>1)</sup> For small cutting depth use cartridges R430.24-2024-12 or R430.23-2024-16. Must be stated in order.

When ordering additional support pads, D and the drilling diameter must be specified in the ordering code.

<sup>2)</sup> Loose chipbreakers are to be used see page 102.

**Ordering example for cartridge for counterboring head**  
 Ø 65 mm: 1 piece R430.24-2024-12

**Ordering example for support pad for counterboring head**  
 Ø 65 mm: 1 piece 430.21-12 D65,0

**Note!** for radial adjustment, see page 78.

**Ordering**

When ordering counterboring heads the following must be stated:

- Drill diameter,  $D_C$ .
- Depth of cut or pre-bored size.
- Insert clamping system to be used – T-Max P lever or T-Max S top clamp.
- Drilling system to be used – Ejector or STS.
- Drill tubes to be used and size  $dm_t$ .

**For more information and advice, please contact your nearest Sandvik representative.**



## Counterboring head



424.31  
Diameter range  
≥ 65,00 mm

## Outer tube, range 14–25

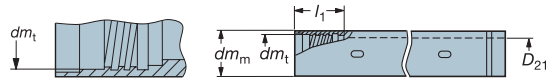

## Inner tube, range 14–25

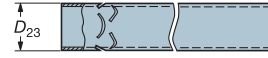
**Note!**

Drill tubes are supplied threaded in both ends,  
with an internal thread, the E-thread.

$dm_t$  is the same as  $dm_m$  for the drill

Diameter range, mm $D_C$ mm	Tube range	Ordering code Outer tube <sup>1)</sup>	Dimensions, mm				Ordering code Inner tube <sup>1)</sup>	Dimensions, mm $D_{23}$
			$dm_m$	$dm_t$	$D_{21}$	$l_1$		
65,00-69,99	14	424.2-814-L <sup>1)</sup>	56	52	43	75	424.2-864-L <sup>1)</sup>	40
70,00-74,99	15	424.2-815-L <sup>1)</sup>	62	58	48	75	424.2-865-L <sup>1)</sup>	44
75,00-79,99	16	424.2-816-L <sup>1)</sup>	68	63	53	75	424.2-866-L <sup>1)</sup>	48
80,00-84,99	17	424.2-817-L <sup>1)</sup>	75	70	59	97	424.2-867-L <sup>1)</sup>	54
85,00-89,99	17	424.2-817-L <sup>1)</sup>	75	70	59	97	424.2-867-L <sup>1)</sup>	54
	18	424.2-818-L <sup>1)</sup>	82	77	66	97	424.2-868-L <sup>1)</sup>	60
90,00-94,99	18	424.2-818-L <sup>1)</sup>	82	77	66	97	424.2-868-L <sup>1)</sup>	60
95,00-99,99	18	424.2-818-L <sup>1)</sup>	82	77	66	97	424.2-868-L <sup>1)</sup>	60
100,00-104,99	19	424.2-819-L <sup>1)</sup>	94	89	78	97	424.2-869-L <sup>1)</sup>	70
105,00-109,99	19	424.2-819-L <sup>1)</sup>	94	89	78	97	424.2-869-L <sup>1)</sup>	70
110,00-114,99	19	424.2-819-L <sup>1)</sup>	94	89	78	97	424.2-869-L <sup>1)</sup>	70
	20	424.2-820-L <sup>1)</sup>	106	101	90	118	424.2-870-L <sup>1)</sup>	80
115,00-119,99	20	424.2-820-L <sup>1)</sup>	106	101	90	118	424.2-870-L <sup>1)</sup>	80
120,00-124,99	20	424.2-820-L <sup>1)</sup>	106	101	90	118	424.2-870-L <sup>1)</sup>	80
	21	424.2-821-L <sup>1)</sup>	118	113	92	118	424.2-871-L <sup>1)</sup>	80
125,00-129,99	21	424.2-821-L <sup>1)</sup>	118	113	92	118	424.2-871-L <sup>1)</sup>	80
130,00-139,99	21	424.2-821-L <sup>1)</sup>	118	113	92	118	424.2-871-L <sup>1)</sup>	80
	22	424.2-822-L <sup>1)</sup>	130	125	104	118	424.2-872-L <sup>1)</sup>	95
140,00-149,99	22	424.2-822-L <sup>1)</sup>	130	125	104	118	424.2-872-L <sup>1)</sup>	95
	23	424.2-823-L <sup>1)</sup>	142	137	116	139	424.2-873-L <sup>1)</sup>	100
150,00-159,99	23	424.2-823-L <sup>1)</sup>	142	137	116	139	424.2-873-L <sup>1)</sup>	100
160,00-169,99	24	424.2-824-L <sup>1)</sup>	154	149	128	139	424.2-874-L <sup>1)</sup>	120
170,00-179,99	24	424.2-824-L <sup>1)</sup>	154	149	128	139	424.2-874-L <sup>1)</sup>	120
	25	424.2-825-L <sup>1)</sup>	166	161	140	139	424.2-875-L <sup>1)</sup>	130
180,00-183,90	25	424.2-825-L <sup>1)</sup>	166	161	140	139	424.2-875-L <sup>1)</sup>	80

<sup>1)</sup> Lengths are manufactured by **customer request**,  
see page 25.

**Note!**

Inner tube 424.2 for drilling diameter 65,00–123,90 mm must be  
ordered 190 mm longer than the outer tube.

Inner tube 424.2 for drilling diameter 124,00–183,90 mm must be  
ordered 220 mm longer than the outer tube.

See page 35 for connecting sleeve:

- Normal type
- Reinforced type A (available on request)

Ordering example for drill tube, design to customer request,  
outer tube length 800 mm and inner tube 830 mm,  
fitting drill head  $D_C = 65,00$  mm:

**1 piece 424.2-814-L800 and 1 piece 424.2-864-L830**

## Inserts



## Vibration dampers



## Mounting parts



## Connectors



## Spare parts









## Cutting data



## Application guide

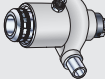
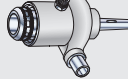

**Mounting parts for rotating and non-rotating connectors, in diameter range 18,40 – 65,00**

Diameter range, mm  <i>D<sub>c</sub></i> mm	Tube range	Mounting parts				Connectors			Non- rotating  Cylindrical
		Collet 	Sealing sleeve 	O-rings: Two outer and one inner. Outer  Inner 		Varilock adapted 	Morse taper 	Flange <sup>1)</sup> mounting 	
18,40-19,20 19,21-20,00	00	424.2-421-00 424.2-420-00	424.2-431-00 424.2-430-00	3671 010-033 3671 010-137	3671 010-024 3671 010-024	424.2-400M-V63	424.2-401M 424.2-400M	424.9S/231-1 424.9S/170-1	424.2-411 424.2-410
20,01-20,90 20,91-21,80	01	424.2-421-01 424.2-420-01	424.2-431-01 424.2-430-01	3671 010-033 3671 010-137	424.2-445-01 424.2-445-01	424.2-400M-V63	424.2-401M 424.2-400M	424.9S/231-1 424.9S/170-1	424.2-411 424.2-410
21,81-22,90 22,91-24,10	02	424.2-421-02 424.2-420-02	424.2-431-02 424.2-430-02	3671 010-033 3671 010-137	424.2-445-02 424.2-445-02	424.2-400M-V63	424.2-401M 424.2-400M	424.9S/231-1 424.9S/170-1	424.2-411 424.2-410
24,11-25,20 25,21-26,40	03	424.2-421-03 424.2-420-03	424.2-431-03 424.2-430-03	3671 010-033 3671 010-137	3671 010-026 3671 010-026	424.2-400M-V63	424.2-401M 424.2-400M	424.9S/231-1 424.9S/170-1	424.2-411 424.2-410
26,41-27,50 27,51-28,70	04	424.2-421-04 424.2-420-04	424.2-431-04 424.2-430-04	3671 010-033 3671 010-137	424.2-445-04 424.2-445-04	424.2-400M-V63	424.2-401M 424.2-400M	424.9S/231-1 424.9S/170-1	424.2-411 424.2-410
28,71-29,80 29,81-31,00	05	424.2-421-05 424.2-420-05	424.2-431-05 424.2-430-05	3671 010-033 3671 010-137	424.2-445-05 424.2-445-05	424.2-400M-V63	424.2-401M 424.2-400M	424.9S/231-1 424.9S/170-1	424.2-411 424.2-410
31,01-32,10 32,11-33,30	06	424.2-421-06 424.2-420-06	424.2-431-06 424.2-430-06	3671 010-033 3671 010-137	3671 010-029 3671 010-029	424.2-400M-V63	424.2-401M 424.2-400M	424.9S/231-1 424.9S/170-1	424.2-411 424.2-410
33,31-34,80 34,81-36,20	07	424.2-421-07 424.2-420-07	424.2-431-07 424.2-430-07	3671 010-033 3671 010-137	3671 010-030 3671 010-030	424.2-400M-V63	424.2-401M 424.2-400M	424.9S/231-1 424.9S/170-1	424.2-411 424.2-410
36,21-37,30 37,31-38,40 38,41-39,60	08	424.2-420-08	424.2-430-08	3671 010-137	3671 010-031	424.2-400M-V63	424.2-400M	424.9S/170-1	424.2-410
39,61-40,60 40,61-41,80 41,81-43,00	09	424.2-420-09	424.2-430-09	3671 010-137	424.2-445-09	424.2-400M-V63	424.2-400M	424.9S/170-1	424.2-410
43,01-44,30 44,31-45,60 45,61-47,00	10	424.2-420-10	424.2-430-10	3671 010-137	424.2-445-10	424.2-400M-V63	424.2-400M	424.9S/170-1	424.2-410
47,01-48,50 48,51-50,10 50,11-51,70	11	424.2-420-11	424.2-430-11	3671 010-137	424.2-445-11	424.2-400M-V63	424.2-400M	424.9S/170-1	424.2-410
51,71-53,20 53,21-54,70 54,71-56,20	12	424.2-420-12	424.2-430-12	3671 010-137	424.2-445-12	424.2-400M-V63	424.2-400M	424.9S/170-1	424.2-410
56,21-58,40 58,41-60,60 60,61-62,80 62,81-65,00	13	424.2-420-13	424.2-430-13	3671 010-137	3671 010-135	424.2-400M-V63	424.2-400M	424.9S/170-1	424.2-410

<sup>1)</sup> Available on request.



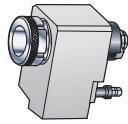

Ordering example: 2 pieces 424.2-421-00

**Varilock adapted connector for automatic tool change**

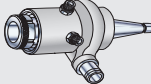

Drill diameter range 18,40-65,00 mm  
For ordering, see page 40.

## Mounting parts for rotating and non-rotating connectors, in diameter range 65,00 – 183,90

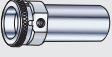
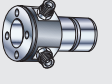
Diameter range, mm	Tube range	Mounting parts			Connectors Rotating		Non- rotating		For more information, see page 38. Tube mounted <sup>2)</sup>
		Connecting sleeve/collet	Sealing sleeve	O-ring	ISO taper	Flange <sup>2)</sup> mounting	Cylindrical		
<i>D<sub>c</sub></i> mm									
65,00-66,99	14	424.2-422-14	424.2-432-14	3671 010-143	424.2-402	424.9S/224-1	424.2-412	424.9S/232-1-14	
67,00-72,99	15	424.2-422-15	424.2-432-15	3671 010-143	424.2-402	424.9S/224-1	424.2-412	424.9S/232-1-15	
73,00-79,99	16	424.2-422-16	424.2-432-16	3671 010-143	424.2-402	424.9S/224-1	424.2-412	424.9S/232-1-16	
80,00-86,99	17	424.2-422-17	424.2-432-17	3671 010-143	424.2-402	424.9S/224-1	424.2-412	424.9S/232-1-17	
87,00-99,99	18	424.2-422-18	424.2-432-18	3671 010-143	424.2-402	424.9S/224-1	424.2-412	424.9S/232-1-18	
100,00-111,99	19	424.2-422-19	424.2-432-19	3671 010-143	424.2-402	424.9S/224-1	424.2-412	424.9S/232-1-19	
112,00-123,99	20	424.2-422-20	424.2-432-20	3671 010-143	424.2-402	424.9S/224-1	424.2-412	424.9S/232-1-20	
65,00-66,99	14	S-424.2-422-14A <sup>1)</sup>	424.2-432-14	3671 010-143	424.2-402	424.9S/224-1	424.2-412	424.9S/232-1-14	
67,00-72,99	15	S-424.2-422-15A <sup>1)</sup>	424.2-432-15	3671 010-143	424.2-402	424.9S/224-1	424.2-412	424.9S/232-1-15	
73,00-79,99	16	S-424.2-422-16A <sup>1)</sup>	424.2-432-16	3671 010-143	424.2-402	424.9S/224-1	424.2-412	424.9S/232-1-16	
80,00-86,99	17	S-424.2-422-17A <sup>1)</sup>	424.2-432-17	3671 010-143	424.2-402	424.9S/224-1	424.2-412	424.9S/232-1-17	
87,00-99,99	18	S-424.2-422-18A <sup>1)</sup>	424.2-432-18	3671 010-143	424.2-402	424.9S/224-1	424.2-412	424.9S/232-1-18	
100,00-111,99	19	S-424.2-422-19A <sup>1)</sup>	424.2-432-19	3671 010-143	424.2-402	424.9S/224-1	424.2-412	424.9S/232-1-19	
112,00-123,99	20	S-424.2-422-20A <sup>1)</sup>	424.2-432-20	3671 010-143	424.2-402	424.9S/224-1	424.2-412	424.9S/232-1-20	
124,00-135,99	21	424.2-423-21	424.2-433-21	3671 010-154	–	424.9S/245-1	424.2-413	424.9S/232-1-21	
136,00-147,99	22	424.2-423-22	424.2-433-22	3671 010-154	–	424.9S/245-1	424.2-413	424.9S/232-1-22	
148,00-159,99	23	424.2-423-23	424.2-433-23	3671 010-154	–	424.9S/245-1	424.2-413	424.9S/232-1-23	
160,00-171,99	24	424.2-423-24	424.2-433-24	3671 010-154	–	424.9S/245-1	424.2-413	424.9S/232-1-24	
172,00-183,90	25	424.2-423-25	424.2-433-25	3671 010-154	–	424.9S/245-1	424.2-413	424.9S/232-1-25	

<sup>1)</sup> New reinforced sleeve, the sleeve has been shortened by 11 mm.  
For customer that have existing tubes must be notified that the inner tube will be too long and thus have to be cut off by 11 mm in the front end. Please note that the length  $l_2$  of outer tube will stay the same and is not affected by the modification.  
Available on request.

Ordering example: 2 pieces 424.2-422-14

<sup>2)</sup> Available on request.

### Rotating connectors

Diameter range: 18,40 – 183,90 mm

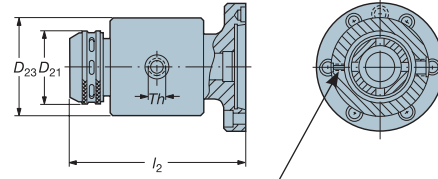
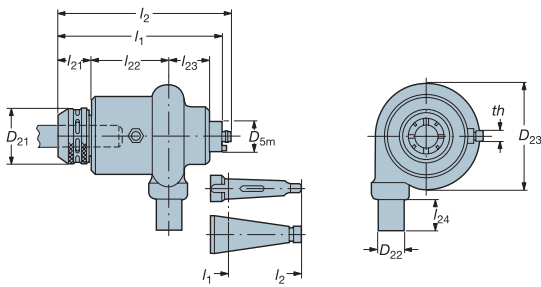

**Please note:** the leakage hole on the flange-mounted connectors must be kept open.

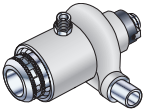
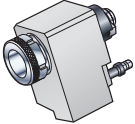
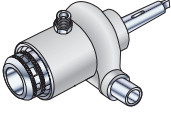
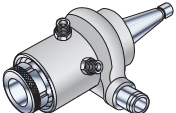
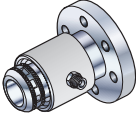
Type of connector	Diameter range, mm <i>D<sub>c</sub></i> mm	Shank	Ordering code	Dimensions, mm											
				<i>dm<sub>m</sub></i>	<i>D<sub>21</sub></i>	<i>D<sub>22</sub></i>	<i>D<sub>23</sub></i>	<i>l<sub>1</sub></i>	<i>l<sub>2</sub></i>	<i>l<sub>21</sub></i>	<i>l<sub>22</sub></i>	<i>l<sub>23</sub></i>	<i>l<sub>24</sub></i>	<i>th</i>	<i>Th</i>
<b>Varilock adapted for manual tool change</b> 	18,40– 65,00	V63	<b>424.2-400M-V63</b>	63	115	53	210	305	–	67	135	85	60	R <sup>3/4</sup> ”	–
<b>Varilock adapted for automatic tool change</b> 	18,40– 43,00 18,40– 65,00	V63 V80	For ordering and information, see page 40.												
<b>Morse taper</b> 	18,40– 36,20 18,40– 65,00	MT4 MT5	<b>424.2-401M</b> <b>424.2-400M</b>	– –	85 115	40 53	160 210	257 309,5	380 465	50 67	123 135	64 85	50 60	R <sup>3/4</sup> ” R <sup>3/4</sup> ”	– –
<b>ISO taper</b> 	65,00–123,90	ISO 50	<b>424.2-402</b>	–	164	100	312	391	521	61	200	108	100	R1”	–
<b>Flange mounting</b> 	18,40– 36,20 18,40– 65,00 65,00–123,90 124,00–183,90	Flange Flange Flange Flange	<b>424.9S/231-1<sup>1)</sup></b> <b>424.9S/170-1<sup>1)</sup></b> <b>424.9S/224-1<sup>1)</sup></b> <b>424.9S/245-1<sup>1)</sup></b>	– – – –	85 115 164 244	– – – –	130 160 225 360	– – – –	235 285 345 400	– – – –	– – – –	– – – –	– – – –	R <sup>3/4</sup> ” R <sup>3/4</sup> ” R1” R1 1/4”	– – – –

<sup>1)</sup> Flange mounted, spindle nose type and size must be specified. Connectors are supplied with nut and spanner. Available on request.

**Ordering example: 1 piece 424.2-400M-V63**



## Non-rotating connectors

Diameter range: 18,40 – 183,90 mm

**Cylindrical shank**  
Diameter 18,40–65,00 mm

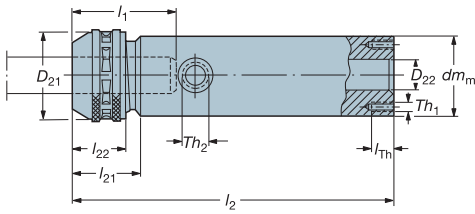

**Example on connectors for NC lathes**  
Mounting specifications of turret lathe are required to design special connectors.

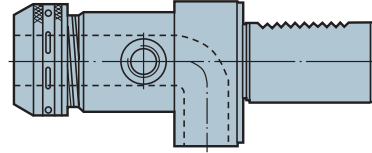

Diameter 65,00–183,90 mm

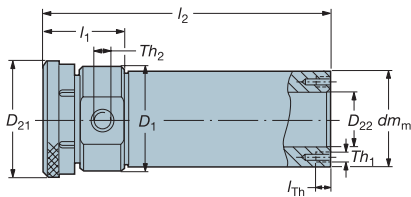

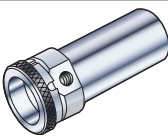
Type of shank	Diameter range, mm	Shank $dm_m$	Ordering code	Dimensions, mm									
				$D_1$	$D_{21}$	$D_{22}$	$l_2$	$l_1$	$l_{21}$	$l_{22}$	$l_{Th}$	$Th_1$	$Th_2$
	18,40– 36,20	75	<b>424.2-411</b>	–	85	30	300	103	63	50	20	M8	R1/2"
	18,40– 65,00	100	<b>424.2-410</b>	–	115	45	330	120	63	50	20	M8	R3/4"
	65,00–123,90	140	<b>424.2-412</b>	160	164	81	416	116	–	–	20	M8	R1"
	124,00–183,90	230	<b>424.2-413</b>	250	244	142	456	156	–	–	20	M8	R1 1/4"

Connectors are supplied with nut and spanner.

Ordering example: 1 piece 424.2-411

Spare parts



108

### Drill mounted connectors – non-rotating

Diameter range: 65,00 – 183,90 mm

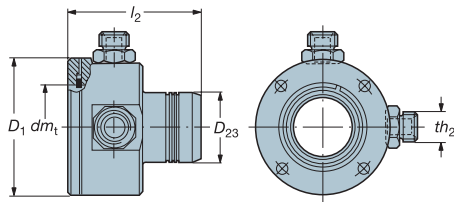

### Mounting of drill tube mounted connector

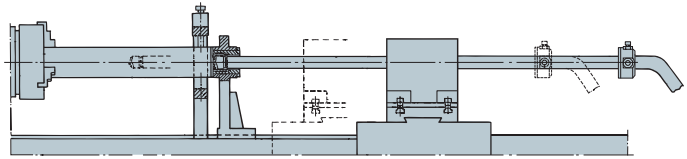

Connectors are supplied with nut and spanner.

Type of shank	Diameter range, mm	Ordering code, connector <sup>1)</sup>	Dimensions, mm				
	$D_c$ mm		$dm_t$	$D_1$	$D_{23}$	$l_2$	$th_2$
	65,00– 66,90	424.9S/232-1-14	56	110	50,5	150	R1"
	67,00– 72,90	424.9S/232-1-15	62	110	50,5	150	R1"
	73,00– 79,90	424.9S/232-1-16	68	120	63,2	150	R1"
	80,00– 86,90	424.9S/232-1-17	75	130	63,2	150	R1"
	87,00– 99,90	424.9S/232-1-18	82	130	75,9	150	R1"
	100,00–111,90	424.9S/232-1-19	94	150	75,9	150	R1"
	112,00–123,90	424.9S/232-1-20	106	160	101,0	150	R1"
	124,00–135,90	424.9S/232-1-21	118	170	101,0	170	R1 1/4"
	136,00–147,90	424.9S/232-1-22	130	185	126,7	170	R1 1/4"
	148,00–159,90	424.9S/232-1-23	142	200	126,7	170	R1 1/4"
	160,00–171,90	424.9S/232-1-24	154	215	126,7	170	R1 1/4"
172,00–183,90	424.9S/232-1-25	166	225	126,7	170	R1 1/4"	

Note! For spare parts, see page 108.

Ordering example: 1 piece 424.9S/232-1-14

1) For connector 424.9S/232-1-xx, the inner tube must be ordered 75 mm longer than the outer tube.

### Drill tubes suitable for drill mounted connectors – non-rotating

Diameter range: 65,00 – 183,90 mm

Outer tube, range 14–25



Inner tube, range 14–25

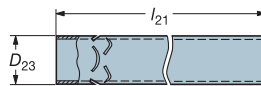
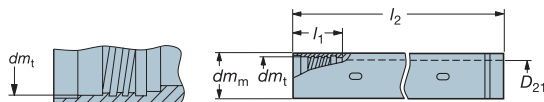

$dm_t$  is the same as  $dm_m$  for the drill

Diameter range, mm	Tube range	Ordering code, <sup>2)</sup> outer tube	Dimensions, mm				Ordering code, inner tube	Dimensions, mm
			$dm_m$	$dm_t$	$D_{21}$	$l_1$		
65,00– 66,90	14	424.9S/233-14	56	52	43	75	424.2-864-L <sup>1)</sup>	40
67,00– 72,90	15	424.9S/233-15	62	58	48	75	424.2-865-L <sup>1)</sup>	44
73,00– 79,90	16	424.9S/233-16	68	63	53	75	424.2-866-L <sup>1)</sup>	48
80,00– 86,90	17	424.9S/233-17	75	70	59	97	424.2-867-L <sup>1)</sup>	54
87,00– 99,90	18	424.9S/233-18	82	77	66	97	424.2-868-L <sup>1)</sup>	60
100,00–111,90	19	424.9S/233-19	94	89	78	97	424.2-869-L <sup>1)</sup>	70
112,00–123,90	20	424.9S/233-20	106	101	90	118	424.2-870-L <sup>1)</sup>	80
124,00–135,90	21	424.9S/233-21	118	113	92	118	424.2-871-L <sup>1)</sup>	80
136,00–147,90	22	424.9S/233-22	130	125	104	118	424.2-872-L <sup>1)</sup>	95
148,00–159,90	23	424.9S/233-23	142	137	116	139	424.2-873-L <sup>1)</sup>	100
160,00–171,90	24	424.9S/233-24	154	149	128	139	424.2-874-L <sup>1)</sup>	120
172,00–183,90	25	424.9S/233-25	166	161	140	139	424.2-875-L <sup>1)</sup>	130

1) Lengths are manufactured by customer request, see page 25.

Ordering example outer tube: 1 piece 424.9S/233-14

2) Available on request.

## Varilock adapted connector for automatic tool change

Deep hole drilling operations are not normally performed on Machining Centres but carried out on conventional or purpose built machines which require dedicated workholding facilities.

The Ejector system developed by Sandvik Coromant however, has been designed to allow deep hole drilling to be performed more effectively on Machining Centres.

Ejector drilling requires high pressure coolant, a feature which most machining centres do not have. To enable this requirement to be incorporated, an extra coolant unit is necessary to obtain the benefits of Ejector drilling.

To deal with the copious amount of coolant supply needed to ensure good chip evacuation, Sandvik Coromant have introduced a Varilock connector with integral coolant supply housing, specially adapted for automatic tool changing.

A Varilock coupling is incorporated into the rear of the connector which allows interchangeability between a wide range of basic holders.

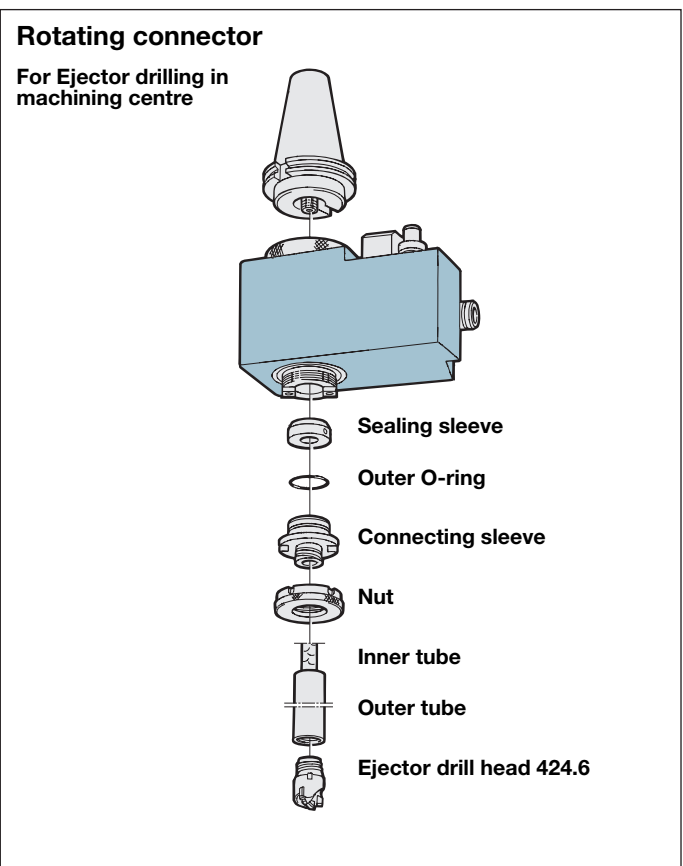

## Machine connection block

The illustration shows three types of machine connection blocks which are necessary if the machine is not already equipped for coolant supply adjacent to the spindle. If you wish to order the machine connection block with the coolant connector, please send full details of the type of block you require and its position on the spindle nose. If your machine is already fitted with a connection block, please send the details with your order.

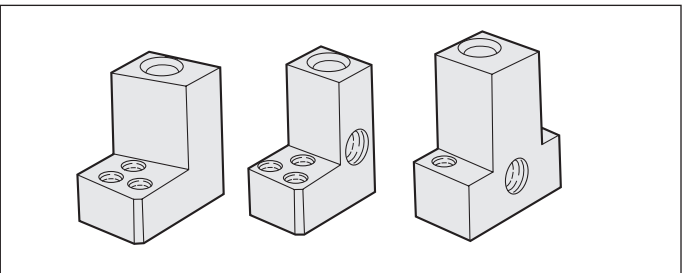

## Pilot holes for Ejector drilling

Method of producing pilot holes:

A deep pilot hole is required when not using a bush to guide the coolant. The tolerance of the hole is plus in relation to the drill diameter.

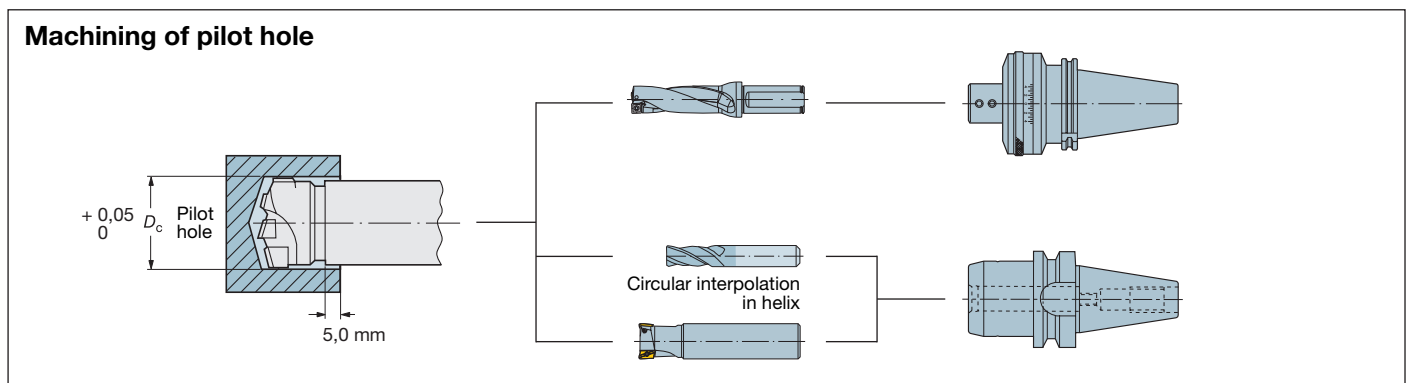

## Varilock coolant connector

When ordering, please complete the details of your requirements below, and send your order or inquiry, to your Sandvik Coromant sales representative.

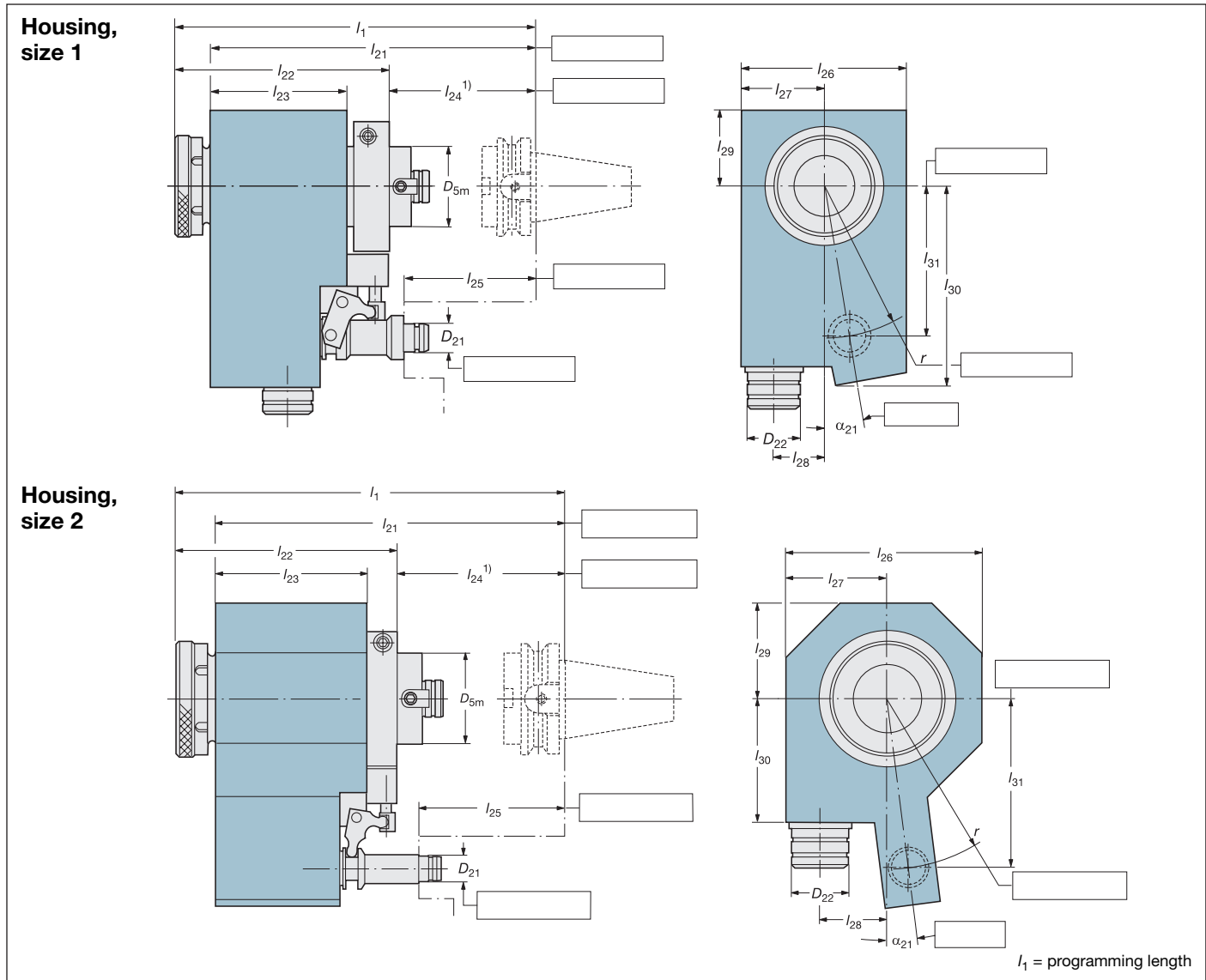

<sup>1)</sup> The connector provides limited space in front of the flange for the toolgripper. If the toolgripper requires a specific space ( $l_{24}$ ) please make sure this measurement is stated on the order.

Housing size	Drill diameter range, mm	Varilock size	Dimensions, mm											Max rev/min	Cutting fluid pressure N/cm <sup>2</sup>		Cutting fluid quantity
			$D_{5m}$	$D_{22}$	$l_{22}$	$l_{23}$	$l_{26}$	$l_{27}$	$l_{28}$	$l_{29}$	$l_{30}$	$l_{31}$	Max		Recommended values	l/min	
1	18,4–43,00	63	40	170	107	130	65	40	60	160	15	3000	200	80–150	50–120		
2	18,4–65,00	80	50	200	135	175	90	60	85	110	25	2500	200	60–150	50–200		

Drill tubes are manufactured by **customer request**.







### Ordering

When ordering the following must be stated:

- Machine type
- Drill diameter
- Taper standard
- Drilling depth
- Taper size
- Drill tube length

For more information and advice, please contact your nearest Sandvik representative.

## Components for Varilock-adapted connector for automatic tool change in machining centres

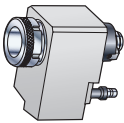
Tuberrange							
	Outer tube <sup>1)</sup>	Inner tube <sup>1)</sup>	Nut <sup>2)</sup>	Connecting <sup>2)</sup> sleeve	Sealing <sup>2)</sup> sleeve	O-ring <sup>2)</sup>	Connector Rotating, Varilock-adapted
00	424.9S/280 Pos 0	424.9S/281 Pos 0	424.9S/279-4.1 840110A16-4	424.9S/282 Pos 0 840110R31-2 Pos 0	424.9S/283 Pos 0 840110R32-2 Pos 0	32 x 1,6 47 x 3	1 2
01	424.9S/280 Pos 1	424.9S/281 Pos 1	424.9S/279-4.1 840110A16-4	424.9S/282 Pos 1 840110R31-2 Pos 1	424.9S/283 Pos 1 840110R32-2 Pos 1	32 x 1,6 47 x 3	1 2
02	424.9S/280 Pos 2	424.9S/281 Pos 2	424.9S/279-4.1 840110A16-4	424.9S/282 Pos 2 840110R31-2 Pos 2	424.9S/283 Pos 2 840110R32-2 Pos 2	32 x 1,6 47 x 3	1 2
03	424.9S/280 Pos 3	424.9S/281 Pos 3	424.9S/279-4.1 840110A16-4	424.9S/282 Pos 3 840110R31-2 Pos 3	424.9S/283 Pos 3 840110R32-2 Pos 3	32 x 1,6 47 x 3	1 2
04	424.9S/280 Pos 4	424.9S/281 Pos 4	424.9S/279-4.1 840110A16-4	424.9S/282 Pos 4 840110R31-2 Pos 4	424.9S/283 Pos 4 840110R32-2 Pos 4	32 x 1,6 47 x 3	1 2
05	424.9S/280 Pos 5	424.9S/281 Pos 5	424.9S/279-4.1 840110A16-4	424.9S/282 Pos 5 840110R31-2 Pos 5	424.9S/283 Pos 5 840110R32-2 Pos 6	32 x 1,6 47 x 3	1 2
06	424.9S/280 Pos 6	424.9S/281 Pos 6	424.9S/279-4.1 840110A16-4	424.9S/282 Pos 6 840110R31-2 Pos 6	424.9S/283 Pos 6 840110R32-2 Pos 6	32 x 1,6 47 x 3	1 2
07	424.9S/280 Pos 7	424.9S/281 Pos 7	424.9S/279-4.1 840110A16-4	424.9S/282 Pos 7 840110R31-2 Pos 7	424.9S/283 Pos 7 840110R32-2 Pos 7	32 x 1,6 47 x 3	1 2
08	424.9S/280 Pos 8	424.9S/281 Pos 8	424.9S/279-4.1 840110A16-4	424.9S/282 Pos 8 840110R31-2 Pos 8	424.9S/283 Pos 8 840110R32-2 Pos 8	32 x 1,6 47 x 3	1 2
09	424.9S/280 Pos 9	424.9S/281 Pos 9	424.9S/279-4.1 840110A16-4	424.9S/282 Pos 9 840110R31-2 Pos 9	424.9S/283 Pos 9 840110R32-2 Pos 9	32 x 1,6 47 x 3	1 2
10	424.9S/280 Pos 10	424.9S/281 Pos 10	840110A16-4	840110R31-2 Pos 10	840110R32-2 Pos 10	47 x 3	2
11	424.9S/280 Pos 11	424.9S/281 Pos 11	840110A16-4	840110R31-2 Pos 11	840110R32-2 Pos 11	47 x 3	2
12	424.9S/280 Pos 12	424.9S/281 Pos 12	840110A16-4	840110R31-2 Pos 12	840110R32-2 Pos 12	47 x 3	2
13	424.9S/280 Pos 13	424.9S/281 Pos 13	840110A16-4	840110R31-2 Pos 13	840110R32-2 Pos 13	47 x 3	2

<sup>1)</sup> Lengths are manufactured by **customer request**.

<sup>2)</sup> Available on request.

**Ordering example: 1 piece 424.9S/280 Pos 0**





A series of horizontal dotted lines spanning the width of the page, intended for writing or drawing.

# DEEP HOLE DRILLING

<b>STS system</b>	
Choice of tools	<b>44-45</b>
Tool mounting – solid drilling and counterboring	<b>46-47</b>
Ground drill head 420.6	<b>48-51</b>
CoroDrill® 800.20	<b>52-55</b>
T-MAX® drill 424.10	<b>56-60</b>
Drill tubes manufactured by customer request	<b>61</b>
Calculation of special length tubes	<b>61</b>
T-MAX® 424.31F and 424.31 counterboring heads	<b>62-69</b>
T-MAX® 420.7 trepanning head	<b>70</b>
Special T-Max® counterboring heads 424.32	<b>71</b>
Mounting parts for connectors	<b>72</b>
STS oil pressure heads	<b>73-74</b>
STS connecting chucks	<b>75</b>
Vibration dampers	<b>76</b>
Adaptors converting from external to internal tube threads	<b>77</b>
Setting the diameters on T-MAX® drills	<b>78</b>
Inserts	<b>79-85</b>
Cutting data and graphs	<b>86-98</b>
Spare parts	<b>99-108</b>
<b>Application guide</b>	<b>119</b>
<b>Trouble shooting</b>	<b>151-152</b>
<b>Material cross reference list</b>	<b>153-157</b>
<b>Insert mounting</b>	<b>158</b>
<b>Safety information</b>	<b>159</b>
<b>Index</b>	<b>161</b>

Data and applications	STS			STS	STS		
	Solid drilling		Trepanning	Solid drilling	Counterboring		
	420.6	800.20	420.7	424.10	424.31F	424.31	424.32
<ul style="list-style-type: none"> <li>• Solid drill heads</li> <li>• Trepanning heads</li> <li>• Counterboring heads</li> <li>• Gun drills</li> </ul> 							
Drill diameter, $D_c$ Drilling depth, $l_4$	15,60–65,00 $150 \times D_c$	25,00–65,00 $150 \times D_c$	$\geq 112,00$ $150 \times D_c$	$\geq 63,50$ $150 \times D_c$	20,00–124,99 $150 \times D_c$	$\geq 65,00$ $150 \times D_c$	$\geq 75,00$ $150 \times D_c$
Page	48	52	70	56	62	62	71
Surface finish Ra	2 $\mu\text{m}$	2 $\mu\text{m}$	3 $\mu\text{m}$	3 $\mu\text{m}$	1 $\mu\text{m}$	3 $\mu\text{m}$	3 $\mu\text{m}$
Hole tolerance	IT9	IT10	IT10	IT10	IT9 – 10	IT10	IT10
Machine							
– DHD machines		Yes		Yes		Yes	
– NC machines		–		–		–	
– Lathes		–		–		–	
– Most conventional machines		–		–		–	
– Machining centres		–		–		–	
– Special gun drilling machines		–		–		–	
Workpiece material							
– Steel	<b>P</b> ◆◆◆	◆◆◆	◆◆◆	◆◆◆	◆◆◆	◆◆◆	◆◆◆
– Stainless steel	<b>M</b> ◆◆◆	◆◆◆	◆◆◆	◆◆◆	◆◆◆	◆◆◆	◆◆◆
– Cast iron	<b>K</b> ◆◆◆	◆◆◆	◆◆◆	◆◆◆	◆◆◆	◆◆◆	◆◆◆
– Aluminium alloys	<b>N</b> ◆◆◆	◆◆◆	◆◆◆	◆◆◆	◆◆	◆◆	◆◆
– Heat resistant alloys	<b>S</b> ◆◆◆	◆◆◆	◆◆◆	◆◆◆			
Tool							
– Internal cutting fluid supply	Yes	Yes	Yes	Yes	Yes	Yes	Yes
– Insert type	–	800-XX T3 08M 800-XX T3 08H	TPMT/R424.9 TPMX/TPUN	TPMT/R424.9 TPMX/TPUN	R424.31F/ SNMG/SNMM	TPMX/TPUN SNMG/SNMM	TPMT/R424.9
Cutting data	See pages 86-98						

Good = ◆◆◆ ← → ◆ = Fair

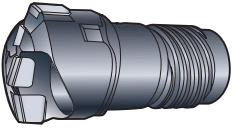
**Ground drill head 420.6**

- 4-6 times faster than gun drilling
- The first choice for hole diameters 15,60-24,99 mm or for dia. 25,00-65,00 mm when extra close diameter tolerance is demanded
- Low investment cost for small batch production
- Standard programme

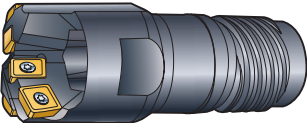
**CoroDrill® 800.20**

- The most productive choice for diameter range 25,00-65,00 mm
- Lowest cost per hole
- Consistent performance within a wide application range
- Standard programme
- Developed and manufactured with the latest technology

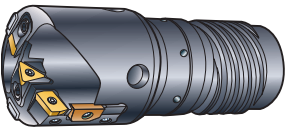
**T-MAX® drill 424.10**

- The choice for large diameters starting from 63,50 mm
- Setting possibilities on diameter
- Good hole straightness in long workpieces
- Stocked standard programme
- Wide range of Tailor Made and engineered solutions

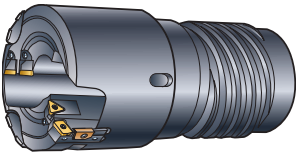
**T-MAX® 420.7 trepanning head – on request**

- Indexable insert design
- For trepanning large diameters with low power requirements
- Drilling depth up to 100 times diameter
- Max diameter depending on machine capacity
- Standard components

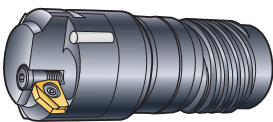
**T-MAX® 424.31F counterboring head – on request**

- When demands for precision, productivity and versatility are high
- Single insert design
- Adjustable insert cartridge head
- Stocked standard components

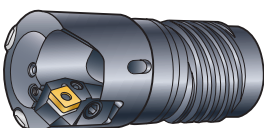
**T-MAX® 424.31 counterboring head – on request**

- When demands for productivity and versatility are high
- Single insert design
- Adjustable insert cartridge head
- Stocked standard components

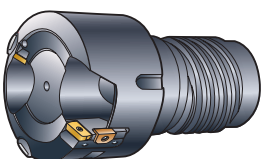
**T-MAX® 424.32 counterboring head – on request**

- Multi-insert design
- Adjustable insert cartridge head
- Wide range of engineered solutions
- Stocked standard components

## Tool mounting – solid drilling and counterboring

**Diameter range, mm**

**Drill heads**

**Drill tubes**

**Oil pressure heads**  
 – with clamping cones  
 – for face sealing only

### Solid drilling

Brazed drill head  
 420.6  
 Page 50

12,60–15,59\*)  
 15,60–65,00



\*)-On special request

CoroDrill® indexable insert  
 drill head 800.20  
 Page 54

25,00–65,00



Drill tube 420.5-  
 Page 51/55



Head 420.9S/  
 Page 74

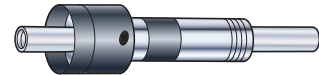

T-Max adjustable  
 drill head 424.10  
 Page 58

63,50–183,90



Drill tube 420.5-  
 Page 59



Head 420.9S/  
 Page 74

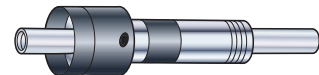

### Counterboring

T-Max single insert  
 counterboring head 424.31F  
 Page 64/66

20,00–124,99

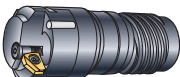

T-Max single insert  
 counterboring head 424.31  
 Page 68

65,00–278,99

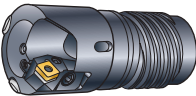

T-Max multi insert  
 counterboring head 424.32  
 Page 71

>75,00

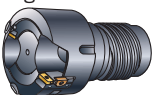

Drill tube 420.5-  
 Page 65/67/69



Head 420.9S/  
 Page 74

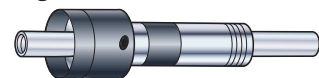

**Vibration dampers (optional)**

**Connecting chucks, - rotating drills - non rotating drills**

**For drill tube diameter  $dm_m$ , mm**

**For drill diameter, mm**

**Collet style**

Chuck 420.9S/524  
Page 75



11-56

15,60-65,00

**Split bushing style**

Chuck 420.9S/520  
Page 75



47-106

51,70-123,90

Chuck 420.9S/521  
Page 75

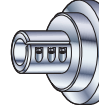

118-166

124,00-183,90

Chuck 420.9S/522  
Page 75

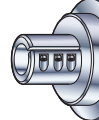

178-238

184,00-255,90

Chuck 420.9S/523  
Page 75

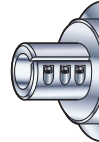

250-382

256,00-399,90

Vibration damper 342-  
Page 76

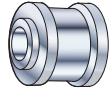

Vibration damper 342-  
Page 76

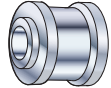

Vibration damper 342-  
Page 76

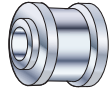



## Ground drill head 420.6

*"The original" precision drill*

Diameter range 15,60 – 65,00 mm

### Easy to use

- No pre-setting
- No need for tool room service

### Excellent hole straightness and surface finish

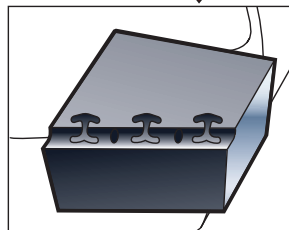

### Customer specified diameter

- Finish ground within 0,01 mm increments

### Reliable performance

- Robust design enables high feed rates
- Sintered insert geometries ensure consistent troublefree chip control in most materials

### Wide application area

- Optimized grade- and geometry combinations for most workpiece materials

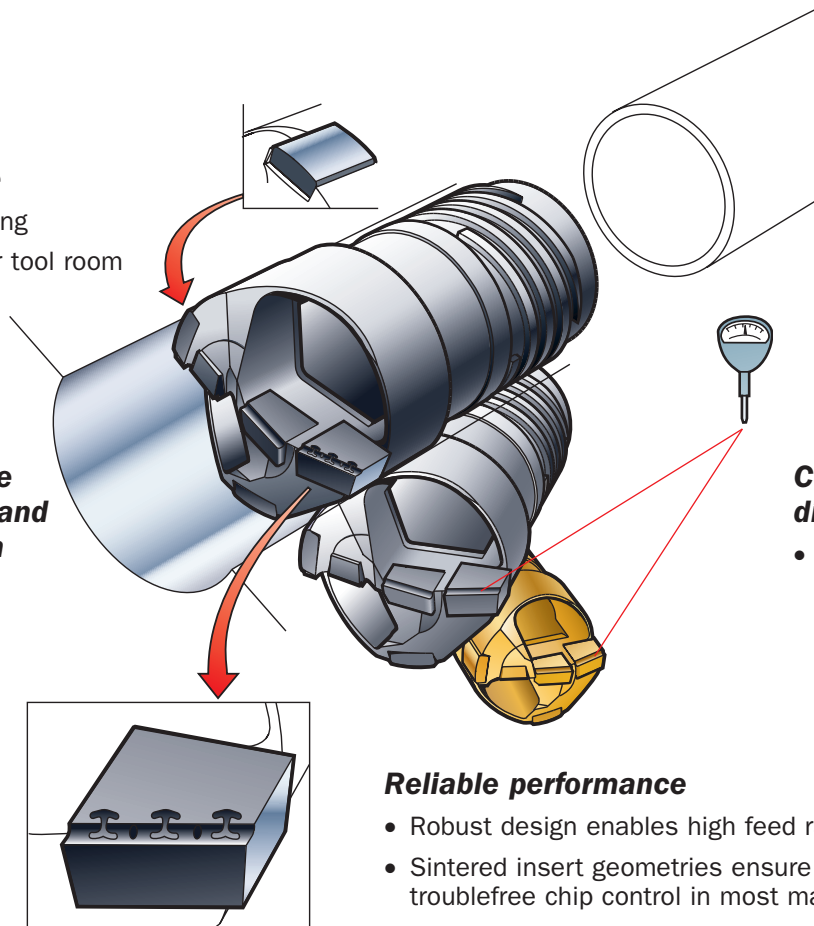

## Ground drill head 420.6

- 4 to 6 times faster than gun drilling
- The first choice for hole diameters 15,60 – 24,99 mm, or in diameter range 25,00 – 65,00 when extra close diameter tolerance is demanded
- Low investment cost for small batch production
- Standard programme

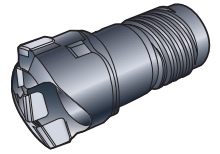

### Preferred STS applications

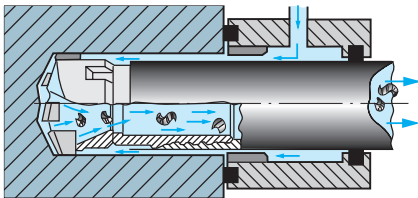

- Special machines for mass production
- Special DHD machines
- Long run production
- Long workpieces
- Material with difficult chipbreaking or uneven structure
- Stainless and low carbon steel

### Typical components – Industry segments

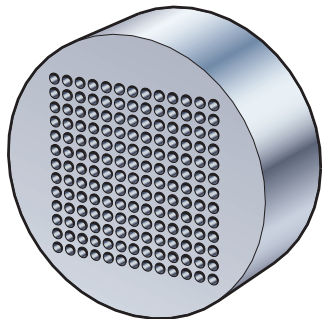

#### Heat exchanger plate

Drill dia,  $D_c$  : 19,40 mm  
 Drill depth,  $l_4$  : 610 mm

#### Power generation

- Heat exchanger plates

#### Mould industry

- Coolant holes

#### Automotive/truck industry

- Axles, piston pins
- Engine block (diesel)
- Hydraulic cylinder
- Track links

#### Steel industry

- Billets

#### Process industry

- Oil holes

#### Aerospace industry

- Landing gear
- Gas turbine axels

#### Ship yard

- Coolant/oil holes in engine blocks

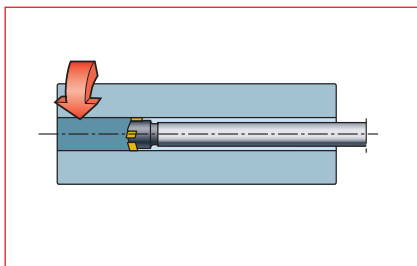

#### Steel billet

Drill dia,  $D_c$  : 44,00 mm  
 Drill depth,  $l_4$  : 600 mm

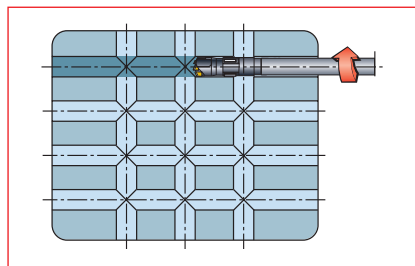

#### Mould coolant holes

Drill dia,  $D_c$  : 15,00 mm (x 9)  
 Drill depth,  $l_4$  : 1000 mm and 2000 mm

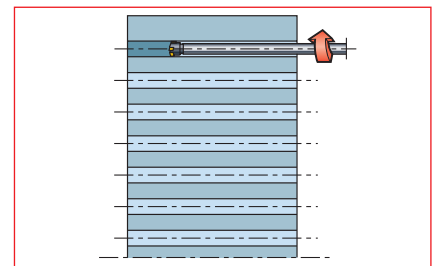

#### Tube plate for boiler

Drill dia,  $D_c$  : 25,70 mm (x 200)  
 Drill depth,  $l_4$  : 360 mm

## STS drill programme - Ground brazed solid drill head 420.6

Diameter range  
15,60 – 65,00 mm

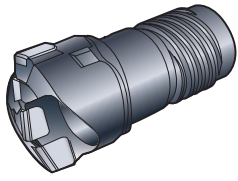

Diameter range: 15,60–65,00 mm  
Hole depth: 150 × Dia.  
Hole tolerance: IT 9  
Surface finish:  $R_a$  2  $\mu$ m  
Cutting fluid: Neat oil or soluble

Drill heads are delivered with standard chipbreaker, finish ground to the desired diameter to tolerance ISO h6.

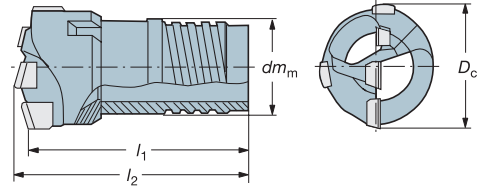

$dm_m$  is the same as  $dm_t$  for the drill tube

Diameter range, mm	Tube range	Ordering code, Drill head <sup>1)</sup>	P M K N S					Dimensions, mm				
			Chipbreaker (w) <sup>2)</sup>					Tolerances, mm				
			4	4	3/2	3	4	4	4	4		
$D_c$ mm	★ = First choice	Coromant grade combination (zz) <sup>1)</sup>	70	63	20	67	72	72	72	$dm_m$	$l_2$	$l_1$
15,60–16,20 16,21–16,70	97	420.6- 971w Dxx.xx zz 972w Dxx.xx zz	★	–	–	★	–	★	★	12,6	43,0	40,3
16,71–17,20 17,21–17,70	98	420.6- 981w Dxx.xx zz 982w Dxx.xx zz	★	–	–	★	–	★	★	13,6	43,0	40,3
17,71–18,40 18,41–18,90	99	420.6- 991w Dxx.xx zz 992w Dxx.xx zz	★	–	–	★	–	★	★	14,5	47,0	44,2
18,91–19,20 19,21–20,00	00	420.6- 001w Dxx.xx zz 002w Dxx.xx zz	★	–	–	★	–	★	★	15,5	47,0	44,0
20,01–20,90 20,91–21,80	01	420.6- 011w Dxx.xx zz 012w Dxx.xx zz	★	☆	★	☆	☆	★	★	16	52,5	49,4
21,81–22,90 22,91–24,10	02	420.6- 021w Dxx.xx zz 022w Dxx.xx zz	★	☆	★	☆	☆	★	★	18	56,0	52,8
24,11–25,20 25,21–26,40	03	420.6- 031w Dxx.xx zz 032w Dxx.xx zz	★	☆	★	☆	☆	★	★	19,5	57,5	54,0
26,41–27,50 27,51–28,70	04	420.6- 041w Dxx.xx zz 042w Dxx.xx zz	★	☆	★	☆	☆	★	★	21	57,5	53,8
28,71–29,80 29,81–31,00	05	420.6- 051w Dxx.xx zz 052w Dxx.xx zz	★	☆	★	☆	☆	★	★	23,5	63,5	59,5
31,01–32,10 32,11–33,30	06	420.6- 061w Dxx.xx zz 062w Dxx.xx zz	★	☆	★	☆	☆	★	★	25,5	63,5	59,1
33,31–34,80 34,81–36,20	07	420.6- 071w Dxx.xx zz 072w Dxx.xx zz	★	☆	★	☆	☆	★	★	28	63,5	59,0
36,21–37,30 37,31–38,40 38,41–39,60	08	420.6- 081w Dxx.xx zz 082w Dxx.xx zz 083w Dxx.xx zz	★	☆	★	☆	☆	★	★	30	73,5	68,7
39,61–40,60 40,61–41,80 41,81–43,00	09	420.6- 091w Dxx.xx zz 092w Dxx.xx zz 093w Dxx.xx zz	★	☆	★	☆	☆	★	★	33	73,5	68,2
43,01–44,30 44,31–45,60 45,61–47,00	10	420.6- 101w Dxx.xx zz 102w Dxx.xx zz 103w Dxx.xx zz	★	☆	★	☆	☆	★	★	36	75,0	69,5
47,01–48,50 48,51–50,10 50,11–51,70	11	420.6- 111w Dxx.xx zz 112w Dxx.xx zz 113w Dxx.xx zz	★	☆	★	☆	☆	★	★	39	75,0	68,8
51,71–53,20 53,21–54,70 54,71–56,20	12	420.6- 121w Dxx.xx zz 122w Dxx.xx zz 123w Dxx.xx zz	★	☆	★	☆	☆	★	★	43	82,0	75,2
56,21–58,40 58,41–60,60 60,61–62,80 62,81–65,00	13	420.6- 131w Dxx.xx zz 132w Dxx.xx zz 133w Dxx.xx zz 134w Dxx.xx zz	★	☆	★	☆	☆	★	★	47	84,0	77,2
60,61–62,80 62,81–65,00	13E	424.6- 133w Dxx.xx zz <sup>3)</sup> 134w Dxx.xx zz <sup>3)</sup>	★	☆	–	☆	–	★	★	51	84,0	76,8

<sup>1)</sup> Drills with other grade combinations and drill diameters 12,60–15,59 mm are available on request.

<sup>2)</sup> No 2 is complementary chipbreaker when harder chipbreaking is required e.g. in duplex stainless steel.

<sup>3)</sup> The Ejector drill 424.6 in diameter range 60,61–65,00 mm together with the drill tube 420.5-813E are an alternative to the corresponding STS drills, where the highest possible stability is required.

When ordering drill heads, state chipbreaker No (w) drill diameter (xx.xx) and grade combination (zz) in the ordering code.

**Ordering example: 2 pieces 420.6-9714 D\*15,60\* 70**

### SAFETY INFORMATION

Precautions when grinding and brazing of cemented carbide, see page 159.

Drill head

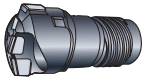

420.6  
Diameter range  
15,60–65,00 mm

Drill tube 420.5-

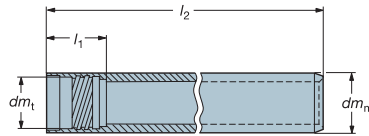

$dm_t$  is the same as  $dm_m$  for the drill

Diameter range, mm $D_c$ mm	Tube range	Ordering code Drill tube <sup>1)</sup>	Dimensions, mm				
			Standard length $l_2$		$dm_m$	$dm_t$	$l_1$
			1600	2600			
15,60–16,20 16,21–16,70	97	420.5-797-	2	–	14	12,6	21
16,71–17,20 17,21–17,70	98	420.5-798-	2	–	15	13,6	21
17,71–18,40 18,41–18,90	99	420.5-799-	2	–	16	14,5	22
18,91–19,20 19,21–20,00	00	420.5-800-	2	–	17	15,5	22
20,01–20,90 20,91–21,80	01	420.5-801-	–	4	18	16	25
21,81–22,90 22,91–24,10	02	420.5-802-	–	4	20	18	26
24,11–25,20 25,21–26,40	03	420.5-803-	–	4	22	19,5	26
26,41–27,50 27,51–28,70	04	420.5-804-	–	4	24	21	26
28,71–29,80 29,81–31,00	05	420.5-805-	–	4	26	23,5	29
31,01–32,10 32,11–33,30	06	420.5-806-	–	4	28	25,5	29
33,31–34,80 34,81–36,20	07	420.5-807-	–	4	30	28	29
36,21–37,30 37,31–38,40 38,41–39,60	08	420.5-808-	–	4	33	30	36
39,61–40,60 40,61–41,80 41,81–43,00	09	420.5-809-	–	4	36	33	36
43,01–44,30 44,31–45,60 45,61–47,00	10	420.5-810-	–	4	39	36	36
47,01–48,50 48,51–50,10 50,11–51,70	11	420.5-811-	–	4	43	39	36
51,71–53,20 53,21–54,70 54,71–56,20	12	420.5-812-	–	4	47	43	40
56,21–58,40 58,41–60,60 60,61–62,80 62,81–65,00	13	420.5-813-	–	4	51	47	40
60,61–62,80 62,81–65,00	13E	420.5-813E- <sup>2)</sup>	–	4	56	51	40

<sup>1)</sup> Other lengths can be manufactured by **customer request**, see page 61.

<sup>2)</sup> 424.6 style Ejector drills can be used in these tubes for greater stability.

Ordering example for drill tube length 1600 mm fitting drill head  $D_c = 16,00$  mm:

**1 piece 420.5-797-2**

Ordering example for drill tube, design to customer request, length 400 mm fitting drill head  $D_c = 22,00$  mm:

**1 piece 420.5-802-L400**

Vibration dampers



76

Oil pressure heads

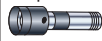

74

Connecting chucks



75

Cutting data



86

Application guide



117

# CoroDrill® 800.20

*The productivity drill*

**Diameter range 25,00 – 65,00 mm**

## **Unique support pad design**

- Indexable economy – two pads in one drill head
- Higher cutting speed – productivity
- Excellent surface finish
- Improves cutting fluid supply

## **Easy to identify**

- Lasermarking of code, dimension and tube range

## **Reliable performance**

- Robust design – high feed per rev. – productivity
- Wear resistant drill body manufactured in hardened steel
- Customer specified diameters
- Close tolerances

## **Excellent hole straightness and surface finish**

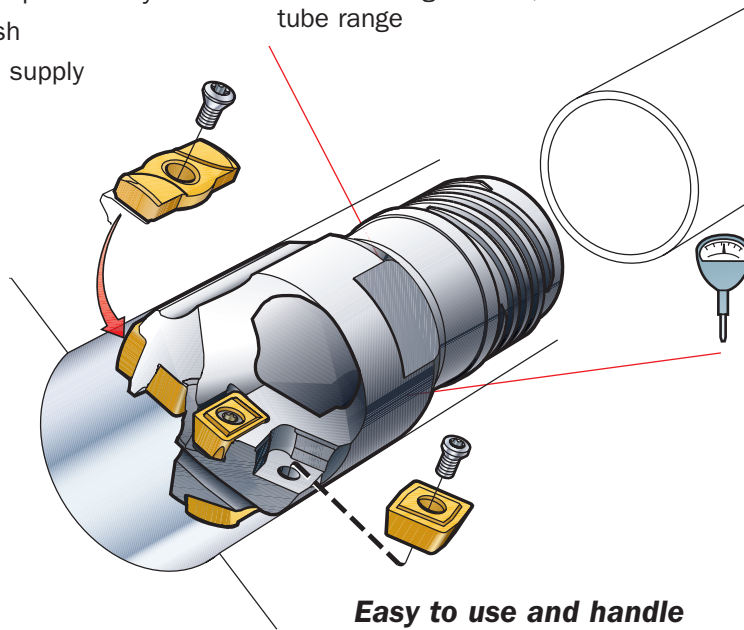

## **Easy to use and handle**

- Fixed insert seats. No pre-setting – no need for tool room services
- Few spare parts – low inventory costs

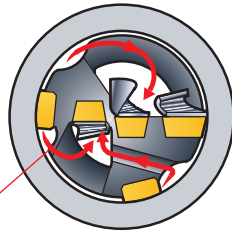

## **"Coolant accelerator"**

- Patent pending design
- Ensures outstanding chip evacuation
- No chip clogging – no production stops

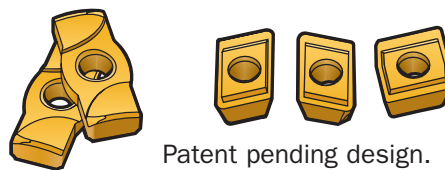

## **Productivity in a wide application range**

- Modern grade and geometry programme cover most work-piece materials
- Few inserts and support pad sizes cover the whole diameter range
- Excellent chip control in both low and high feeds

# CoroDrill® 800.20

- **The most productive choice for diameter range 25,00 – 65,00 mm**
- **Lowest cost per hole**
- **Consistent performance within a wide application area**
- **Standard programme**
- **Developed and manufactured with the latest technology**

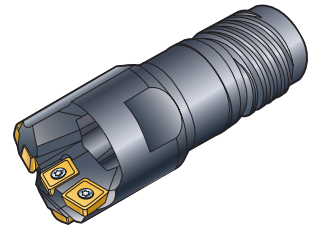

## Preferred STS applications

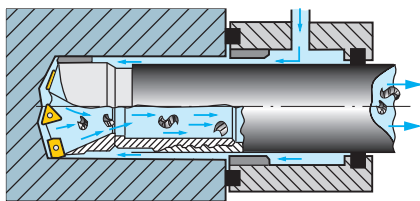

- Special machines for mass production
- Special DHD machines
- Long workpieces
- Material with difficult chipbreaking or uneven structure
- Stainless and low carbon steel

## Typical components – Industry segments

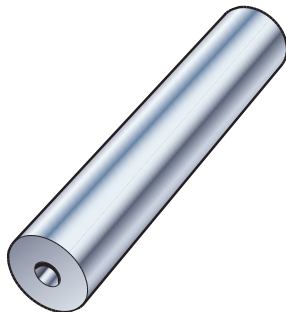

### Automotive industry

- Axles, piston pins
- Engine block (diesel)
- Hydraulic cylinder
- Track links

### Steel industry

- Billets

### Process industry

- Oil holes

### Aerospace industry

- Landing gear
- Gas turbine axles

### Ship yard

- Coolant/oil holes in engine blocks

### Defence industry

- Barrels

### Billet for rock tools

Drill dia,  $D_c$  : 40,00 mm

Drill depth,  $l_4$  : 1300 mm

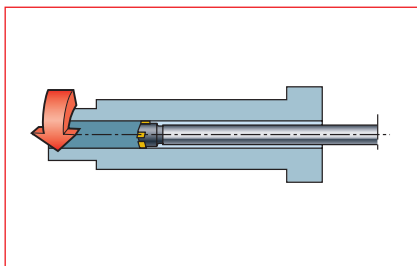

### Machine spindle

Drill dia,  $D_c$  : 38,20 mm

Drill depth,  $l_4$  : 560 mm

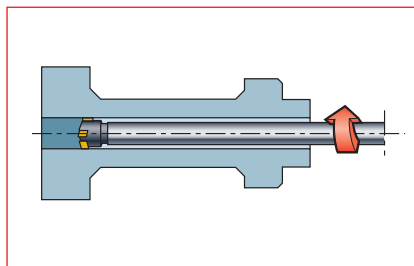

### Hydraulic cylinder

Drill dia,  $D_c$  : 31,75 mm

Drill depth,  $l_4$  : 500 mm

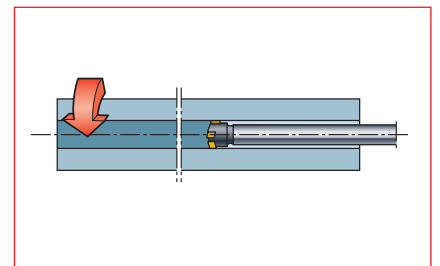

### Cylinder

Drill dia,  $D_c$  : 32,00 mm (x26)

Drill depth,  $l_4$  : 900 mm



**STS programme –  
CoroDrill® solid drill head 800.20**

Indexable insert design  
Diameter range  
25,00 – 65,00 mm

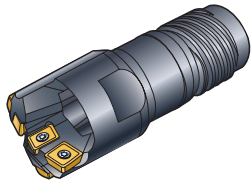

**Diameter range:** 25,00–65,00 mm  
**Hole depth:** 150 × Dia.  
**Hole tolerance:** IT 10  
**Surface finish:** R<sub>a</sub> 2 µm  
**Cutting fluid:** Neat oil or soluble with EP-additives

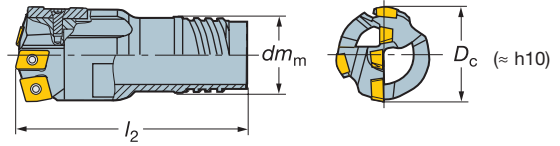

**Note!**  
The drill is manufactured to minus tolerance so that it will not exceed the drill bush diameter, see page 136.

*dm<sub>m</sub> is the same as dm<sub>t</sub> for the drill tube*

Diameter range, mm <i>D<sub>C</sub></i> mm	Tube range	Ordering code, Drill head	Dimensions, mm		Inserts			Support pads	
			<i>dm<sub>m</sub></i>	<i>≤ l<sub>2</sub></i>	Central	Intermediate	Peripheral	Pad	No.
25,00–26,40	03	800.20-03Dxx.xx	19,5	75	800-05 03 08M-C-G	800-05 03 08M-I-G	800-06 03 08H-P-G	800-06A	2
26,41–28,70	04	800.20-04Dxx.xx	21	78	800-05 03 08M-C-G	800-05 03 08M-I-G	800-06 03 08H-P-G	800-06A	2
28,71–31,00	05	800.20-M05Dxx.xx	23,5	80	800-06 T3 08M-C-G	800-05 03 08M-I-G	800-06 03 08H-P-G	800-06A	2
31,01–33,30	06	800.20-06Dxx.xx	25,5	85,0	800-06 T3 08M-C-G	800-06 T3 08M-I-G	800-08 T3 08H-P-G	800-07A	2
33,31–36,20	07	800.20-07Dxx.xx	28,0	85,0	800-06 T3 08M-C-G <sup>1)</sup> 800-08 T3 08M-C-G <sup>1)</sup>	800-06 T3 08M-I-G <sup>1)</sup> 800-08 T3 08M-I-G <sup>1)</sup>	800-08 T3 08H-P-G	800-07A	2
36,21–39,60	08	800.20-08Dxx.xx	30,0	95,0	800-08 T3 08M-C-G	800-08 T3 08M-I-G	800-08 T3 08H-P-G <sup>1)</sup> 800-09 T3 08H-P-G <sup>1)</sup>	800-07A	2
39,61–43,00	09	800.20-09Dxx.xx	33,0	100,0	800-08 T3 08M-C-G	800-08 T3 08M-I-G	800-09 T3 08H-P-G	800-08A	2
43,01–47,00	10	800.20-10Dxx.xx	36,0	100,0	800-10 T3 08M-C-G	800-08 T3 08M-I-G	800-09 T3 08H-P-G	800-08A	2
47,01–51,70	11	800.20-11Dxx.xx	39,0	110,0	800-12 T3 08M-C-G <sup>1)</sup> 800-10 T3 08M-C-G <sup>1)</sup>	800-08 T3 08M-I-G	800-09 T3 08H-P-G <sup>1)</sup> 800-11 T3 08H-P-G <sup>1)</sup>	800-10A	2
51,71–56,20	12	800.20-12Dxx.xx	43,0	120,0	800-10 T3 08M-C-G	800-08 T3 08M-I-G <sup>1)</sup> 800-12 T3 08M-I-G <sup>1)</sup>	800-11 T3 08H-P-G	800-10A <sup>1)</sup> 800-12A <sup>1)</sup>	2 2
56,21–65,00	13	800.20-13Dxx.xx	47,0	125,0	800-10 T3 08M-C-G <sup>1)</sup> 800-12 T3 08M-C-G <sup>1)</sup>	800-12 T3 08M-I-G	800-11 T3 08H-P-G	800-12A	2
60,61–65,00	13E	800.24-13Dxx.xx <sup>2)</sup>	51,0	125,0	800-10 T3 08M-C-G <sup>1)</sup> 800-12 T3 08M-C-G <sup>1)</sup>	800-12 T3 08M-I-G	800-11 T3 08H-P-G	800-12A	2

<sup>1)</sup> To match insert/support pad sizes to required drill diameter, see below table.

When ordering drill heads, state drill diameter (xx.xx) in the ordering code.

**Ordering example, drill head: 2 pieces 800.20-03D\*25.00\***

<sup>2)</sup> The Ejector drill 800.24 in diameter range 60,61–65,00 mm together with the drill tube 420.5-813E are an alternative to the corresponding STS drills, where the highest possible stability is required.

**Drill diameter range – insert and pad sizes**

Inserts (Ordered separately)						Support pads (Ordered separately)				
Intermediate and peripheral inserts are also available in L- geometry (for long chipping materials) see page 81.										
Diameter range, mm	Insert	Central	Diameter range, mm	Insert	Intermediate	Diameter range, mm	Insert	Peripheral	Diameter range, mm	Pad
25,00–28,70	05	800-05 03 08M-C-G	25,00–31,00	05	800-05 03 08M-I-G	25,00–31,00	06	800-06 03 08H-P-G	25,00–31,00	800-06A
28,71–33,99	06	800-06 T3 08M-C-G	31,01–34,99	06	800-06 T3 08M-I-G	31,01–38,99	08	800-08 T3 08H-P-G	31,01–39,60	800-07A
34,00–43,00	08	800-08 T3 08M-C-G	35,00–54,99	08	800-08 T3 08M-I-G	39,00–49,99	09	800-09 T3 08H-P-G	39,61–47,00	800-08A
43,01–47,00	10	800-10 T3 08M-C-G	55,00–65,00	12	800-12 T3 08M-I-G	50,00–65,00	11	800-11 T3 08H-P-G	47,01–54,99	800-10A
47,01–49,99	12	800-12 T3 08M-C-G							55,00–65,00	800-12A
50,00–57,99	10	800-10 T3 08M-C-G								
58,00–65,00	12	800-12 T3 08M-C-G								



Drill head

Drill tube 420.5-



800.20  
Diameter range  
25,00–65,00 mm

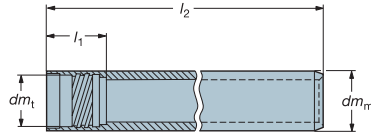

$dm_t$  is the same as  $dm_m$  for the drill

Diameter range, mm $D_c$ mm	Tube range	Ordering code Drill tube <sup>1)</sup>	Dimensions, mm			
			Standard length $l_2$ 2600	$dm_m$	$dm_t$	$l_1$
25,00–26,40	03	420.5-803-	4	22	19,5	26
26,41–28,70	04	420.5-804-	4	24	21	26
28,71–31,00	05	420.5-805-	4	26	23,5	29
31,01–33,30	06	420.5-806-	4	28	25,5	29
33,31–36,20	07	420.5-807-	4	30	28	29
36,21–39,60	08	420.5-808-	4	33	30	36
39,61–43,00	09	420.5-809-	4	36	33	36
43,01–47,00	10	420.5-810-	4	39	36	36
47,01–51,70	11	420.5-811-	4	43	39	36
51,71–56,20	12	420.5-812-	4	47	43	40
56,21–65,00	13	420.5-813-	4	51	47	40
60,61–65,00	13E	420.5-813E- <sup>2)</sup>	4	56	51	40

<sup>1)</sup> Other lengths can be manufactured by **customer request**, see page 61.

<sup>2)</sup> 800.24 style Ejector drills can be used in these tubes for greater stability.

Ordering example for drill tube length 2600 mm fitting drill head  $D_c = 30,00$  mm:

**1 piece 420.5-805-4**

Ordering example for drill tube, design to customer request, length 400 mm fitting drill head  $D_c = 37,00$  mm:

**1 piece 420.5-808-L400**

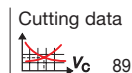
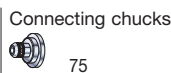

# T-MAX® drill 424.10

*The adjustable drill*

**Diameter range 63,50 – 130,00\* mm**

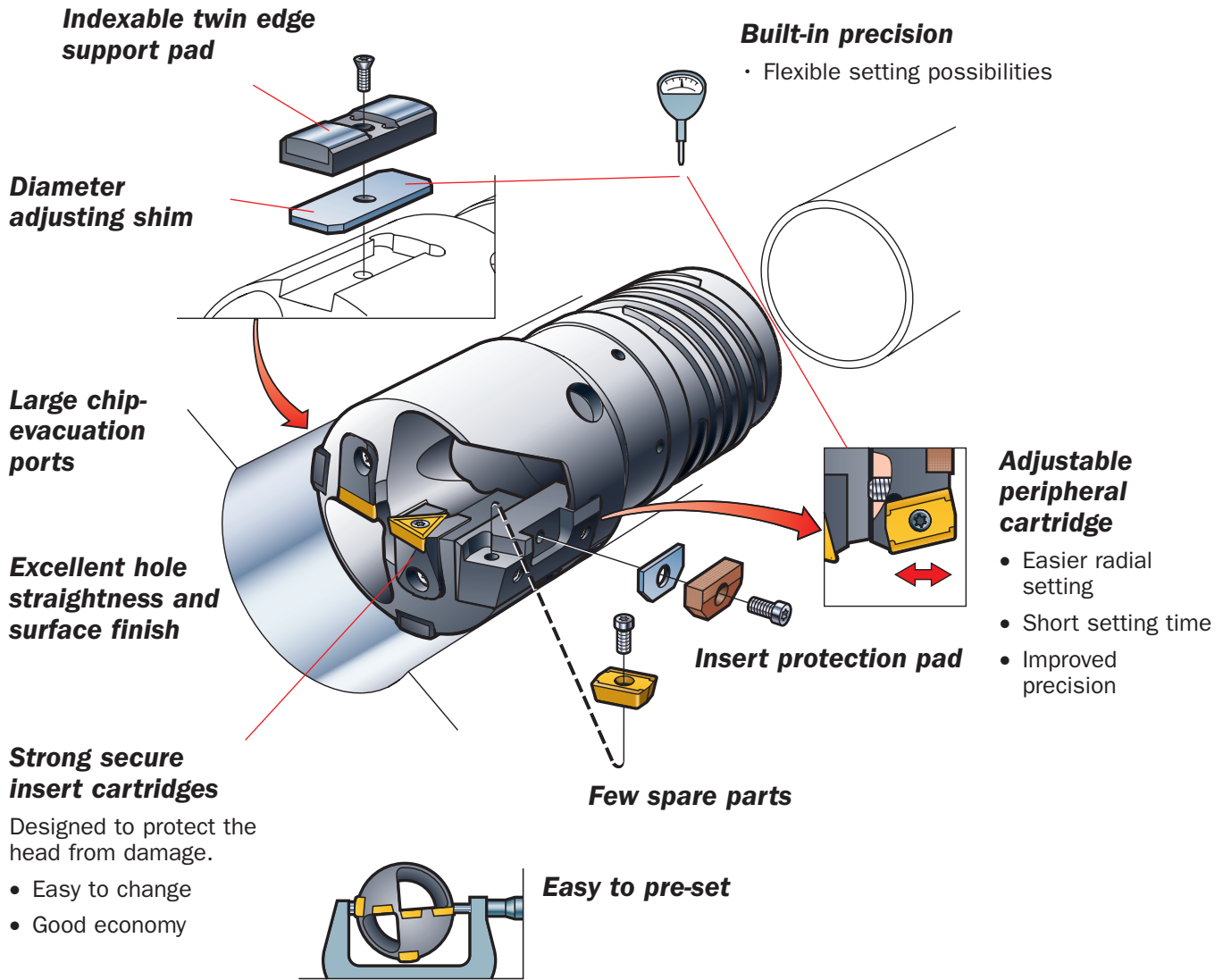

**Strong secure insert cartridges**

Designed to protect the head from damage.

- Easy to change
- Good economy

*Tailor Made*

- Intermediate diameters from 63,50 to 183,99\* mm
- Two thread size options per head size

\*)Larger diameters on request

**Modern inserts – machining economy**

- Four insert types cover the whole diameter range
- Geometries and grades for drilling most materials
- Grade GC1025 the best choice for both steel and stainless steel
- High feed rate

# T-MAX® drill 424.10

## Setting possibilities on diameter

- Close diameter tolerance and high surface finish
- Good hole straightness in long workpieces
- Wide application area
- High penetration rate in most materials
- Stocked standard programme
- Wide range of engineered solutions

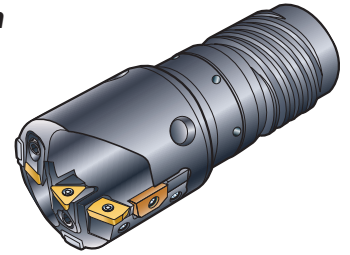

## Preferred STS applications

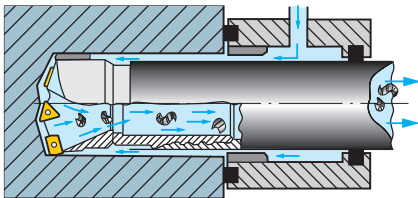

- Special machines for mass production
- Special DHD machines
- Long run production
- Long workpieces
- Material with difficult chipbreaking or uneven structure
- Stainless and low carbon steel

## Typical components – Industry segments

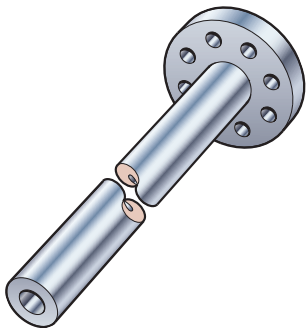

### Automotive industry

- Engine block (diesel)

### Steel industry

- Billets

### Process industry

- Oil holes

### Aerospace industry

- Landing gear

### Ship yard

- Propeller axles
- Push rods
- Coolant / oil holes in engine blocks

### Defence industry

- Barrels

### Propeller axle

Drill dia,  $D_c$  : 150,00 mm  
 Drill depth,  $l_4$  : 14000 mm

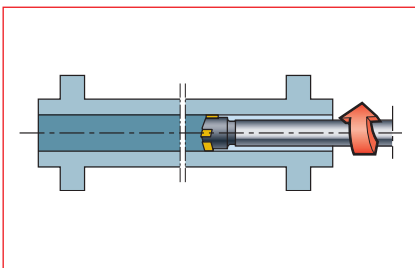

### Propeller shaft

Drill dia,  $D_c$  : 330,00 mm  
 Drill depth,  $l_4$  : 17069 mm

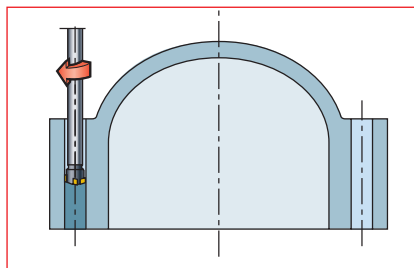

### Pressure head

Drill dia,  $D_c$  : 170,00 mm (x26)  
 Drill depth,  $l_4$  : 1100 mm

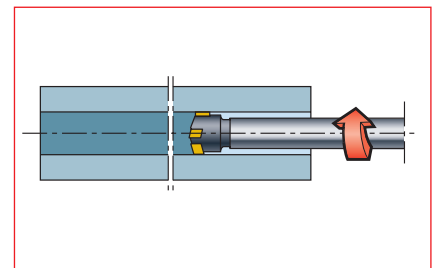

### Rod

Drill dia,  $D_c$  : 77,00 mm  
 Drill depth,  $l_4$  : 9000 mm

**STS programme –  
T-MAX® adjustable solid drill head A424.10 / 424.10**

Indexable insert design  
Diameter range  
63,50 – 183,90 mm

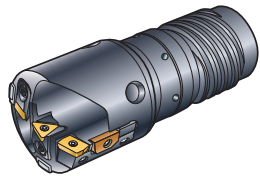

Diameter range: 63,50–183,90 mm  
Hole depth: 100 × Dia.  
Hole tolerance: IT 10  
Surface finish: Ra 3 µm  
Cutting fluid: Neat oil or soluble with EP-additives

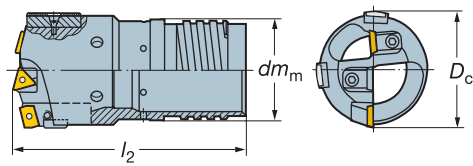

$dm_m$  is the same as  $dm_t$  for the drill tube

Diameter <sup>2)</sup> range, mm	Tube range	Ordering code, Drill head <sup>1)</sup>	Dimensions, mm			Cartridges							
			$dm_m$	$l_2$	Radial <sup>3)</sup> adjust- ment	Central	No.	Inter- mediate	No.	Peripheral	No.	Support pad	No.
63,50	13	A424.10-2500	47	115	+1	L430.31-1216-16	1	R430.30-1216-16	1	R430.28-1516-16	1	430.32-12 D65,0	2
65,00	13E	424.10-0650 E	51	115	+1,5	L430.31-1216-16	1	R430.30-1216-16	1	R430.28-1516-16	1	430.32-12 D65,0	2
65,00	14	424.10-0650	52	150	+1,5	L430.31-1216-16	1	R430.30-1216-16	1	R430.28-1516-16	1	430.32-12 D65,0	2
69,85	15	A424.10-2750	58	150	+1	L430.31-1216-16	1	R430.30-1216-16	1	R430.28-1516-16	1	430.32-12 D65,0	2
70,00		424.10-0700	58	150	+1	L430.31-1216-16	1	R430.30-1216-16	1	R430.28-1516-16	1	430.32-12 D70,0	2
71,45		A424.10-2813	58	150	+0,75	L430.31-1216-16	1	R430.30-1216-16	1	R430.28-1516-16	1	430.32-12 D70,0	2
75,00	16	424.10-0750	63	160	+2	L430.31-1216-16	1	R430.30-1216-16	1	R430.28-1822-22	1	430.32-12 D75,0	2
76,20		A424.10-3000	63	160	+2	L430.31-1216-16	1	R430.30-1216-16	1	R430.28-1822-22	1	430.32-12 D75,0	2
80,00	17	424.10-0800	70	190	+1,25	L430.31-1216-16	1	R430.30-1216-16	1	R430.28-1822-22	1	430.32-12 D80,0	2
82,55		A424.10-3250	70	190	+0,75	L430.31-1216-16	1	R430.30-1216-16	1	R430.28-1822-22	1	430.32-12 D80,0	2
85,00		424.10-0850	70	190	+1,75	L430.31-1522-22	1	R430.30-1216-16	1	R430.28-1822-22	1	430.32-12 D85,0	2
88,90	18	A424.10-3500	77	190	+1,75	L430.31-1522-22	1	R430.30-1216-16	1	R430.28-1822-22	1	430.32-12 D85,0	2
90,00		424.10-0900	77	190	+1,75	L430.31-1522-22	1	R430.30-1216-16	1	R430.28-1822-22	1	430.32-12 D90,0	2
95,00		424.10-0950	77	190	+2	L430.31-1522-22	1	R430.30-15 22-22	1	R430.28-1822-22	1	430.32-12 D95,0	2
95,25		A424.10-3750	77	190	+2	L430.31-1522-22	1	R430.30-15 22-22	1	R430.28-1822-22	1	430.32-12 D95,0	2
100,00	19	424.10-1000	89	195	+1	L430.31-1522-22	1	R430.30-15 22-22	1	R430.28-1822-22	1	430.32-16 D100,0	2
101,60		A424.10-4000	89	195	+1,25	L430.31-1522-22	1	R430.30-15 22-22	1	R430.28-1822-22	1	430.32-16 D100,0	2
105,00		424.10-1050	89	195	+0,5	L430.31-1522-22	1	R430.30-15 22-22	1	R430.28-1822-22	1	430.32-16 D105,0	2
107,95		A424.10-4250	89	195	+2	L430.31-1216-16	1	R430.30-1216-16	1	R430.28-1516-16	1	430.32-16 D105,0	2
110,00		424.10-1100	89	195	+1,5	L430.31-1216-16	1	R430.30-1216-16	1	R430.28-1516-16	1	430.32-16 D110,0	2
114,30	20	A424.10-4500	101	220	+1,75	L430.31-1216-16	1	R430.30-1216-16	3	R430.28-1516-16	1	430.32-16 D110,0	2
115,00		424.10-1150	101	220	+1,5	L430.31-1216-16	1	R430.30-1216-16	3	R430.28-1516-16	1	430.32-16 D115,0	2
120,00		424.10-1200	101	220	+1,5	L430.31-1216-16	1	R430.30-1216-16	3	R430.28-1516-16	1	430.32-16 D120,0	2
120,65		A424.10-4750	101	220	+1,5	L430.31-1216-16	1	R430.30-1216-16	3	R430.28-1516-16	1	430.32-16 D120,0	2
125,00	21	424.10-1250	113	220	+1,75	L430.31-1216-16	1	R430.30-1216-16	3	R430.28-1822-22	1	430.32-16 D125,0	2
127,00		A424.10-5000	113	220	+1,25	L430.31-1216-16	1	R430.30-1216-16	3	R430.28-1822-22	1	430.32-16 D125,0	2
130,00		424.10-1300	113	220	+0,5	L430.31-1216-16	1	R430.30-1216-16	3	R430.28-1822-22	1	430.32-16 D130,0	2
136,00-147,90	22	Tailor Made											
148,00-159,90	23	Tailor Made											
160,00-171,90	24	Tailor Made											
172,00-183,90	25	Tailor Made											

1) "A" in the ordering code indicates drill with inch dimensions.

2) Drills in other dimensions are available on request.

3) For radial adjustment, see page 78.

Ordering example, complete drill head: 2 pieces 424.10-0650

For Ordering additional cartridge/support pad:  
2 pieces L430.31-1216-16  
4 pieces 430.32-12 D65,0

Inserts (Ordered separately)							
Central cartridge	Insert	Intermediate cartridge	Insert	Peripheral cartridge	Insert		
L430.31-1216-16	16 TPMT 16T312R-22 16 TPMT 16T312TR-23	R430.30-1216-16	16 TPMT 16T312R-22 16 TPMT 16T312TR-23	R430.28-1516-16	13 R424.9-13T308-22 13 R424.9-13T308-23		
L430.31-1522-22	22 TPMT 220612R-22 22 TPMT 220612TR-23	R430.30-1522-22	22 TPMT 220612R-22 22 TPMT 220612TR-23	R430.28-1822-22	18 R424.9-180608-22 18 R424.9-180608-23		

**Drill head**



**A424.10 / 424.10**  
**Diameter range**  
**63,50–183,90 mm**

**Drill tube 420.5-**

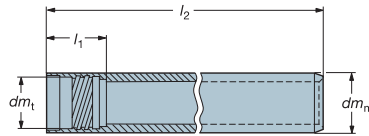

$dm_t$  is the same as  $dm_m$  for the drill

Diameter range, mm $D_C$ mm	Tube range	Ordering code Drill tube <sup>1)</sup>	Dimensions, mm			
			Standard length $l_2$ 2600	$dm_m$	$dm_t$	$l_1$
63,50 65,00	13 13E	420.5-813- 420.5-813E- <sup>2)</sup>	4 4	51 56	47 51	40 40
65,00	14	420.5-814-L <sup>1)</sup>	–	56	52	75
69,85 70,00 71,45	15	420.5-815-L <sup>1)</sup>	–	62	58	75
75,00 76,20	16	420.5-816-L <sup>1)</sup>	–	68	63	75
80,00 82,55 85,00	17	420.5-817-L <sup>1)</sup>	–	75	70	97
88,90 90,00 95,00 95,25	18	420.5-818-L <sup>1)</sup>	–	82	77	97
100,00 101,60 105,00 107,95 110,00	19	420.5-819-L <sup>1)</sup>	–	94	89	97
114,30 115,00 120,00 120,65	20	420.5-820-L <sup>1)</sup>	–	106	101	118
125,00 127,00 130,00	21	420.5-821-L <sup>1)</sup>	–	118	113	118
136,00-147,90	22	420.5-822-L <sup>1)</sup>	–	130	125	118
148,00-159,90	23	420.5-823-L <sup>1)</sup>	–	142	137	139
160,00-171,90	24	420.5-824-L <sup>1)</sup>	–	154	149	139
172,00-183,90	25	420.5-825-L <sup>1)</sup>	–	166	161	139

<sup>1)</sup> Lengths are manufactured by **customer request**, see page 61.

Ordering example for drill tube length 2600 mm fitting drill head  $D_C = 63,50$  mm:

**1 piece 420.5-813-4**

Ordering example for drill tube, design to customer request, length 400 mm fitting drill head  $D_C = 75,00$  mm:

**1 piece 420.5-816-L400**

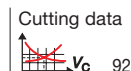





- Quick quotation
- Easy to order
- Competitive delivery

**Even more possibilities thanks to tailored design!**

If you do not find what you need in our comprehensive standard programme, choose the tool shape you require and we will tailor it for you to *your* dimensions.

**T-Max adjustable solid drill head 424.10**

**$D_c = 63,50 - 183,99$  mm, with E-thread**

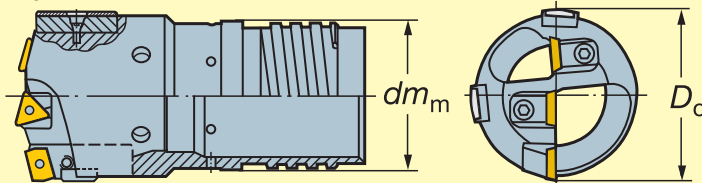

$D_c$	$dm_m$	E-thread range <sup>1)</sup>
63,50- 64,99	51	13
65,00- 66,99	51 / 52	13 / 14
67,00- 72,99	52 / 58	14 / 15
73,00- 79,99	58 / 63	15 / 16
80,00- 86,99	63 / 70	16 / 17
87,00- 99,99	70 / 77	17 / 18
100,00-111,99	77 / 89	18 / 19
112,00-123,99	89 / 101	19 / 20
124,00-135,99	101 / 113	20 / 21
136,00-147,99	113 / 125	21 / 22
148,00-159,99	125 / 137	22 / 23
160,00-171,99	137 / 149	23 / 24
172,00-183,99	149 / 161	24 / 25

<sup>1)</sup> Compare with drill tube  
(424.2 – 8xx Ejector / 420.5 – 8xx STS)

**Options**

**Note** For specific details regarding the options, contact your Sandvik Coromant sales representative.

$D_c$  Diameter – **63,50–183,90** mm  
 $dm_m$  Thread size – **51–161**

**Drill tubes manufactured by customer request**

**Note!** For specific details regarding the options, contact your Sandvik Coromant sales representative.

Drill head	Tube range	Outer tube Dimensions, mm	For drawings and complementary dimensions, see page:	Drill head	Tube range	Outer tube Dimensions, mm	For drawings and complementary dimensions, see page:
		Length to customer request $l_2$ (Min - Max)				Length to customer request $l_2$ (Min - Max)	
420.6	97 - 00 01 - 13 13E	220 - 4000 220 - 5300 220 - 5000	51	424.31F	00 - 09	220 - 5000	65
800.20	03 - 13 13E	220 - 5300 220 - 5000	55	424.31F	10 - 18 19 - 21	220 - 5000 220 - 3000	67
424.10	13E 13 - 18 19 - 25	220 - 5000 220 - 5000 220 - 3000	59	424.31	14 - 18 19 - 26	220 - 5000 220 - 5000	69

Ordering example for drill tube, design to customer request, length 800 mm fitting drill head  $D_c = 75,00$  mm:

**1 piece 420.5-816-L800**

**Calculation of special length tubes – STS system**

For solid drill heads 420.6, 800.20 and 424.10

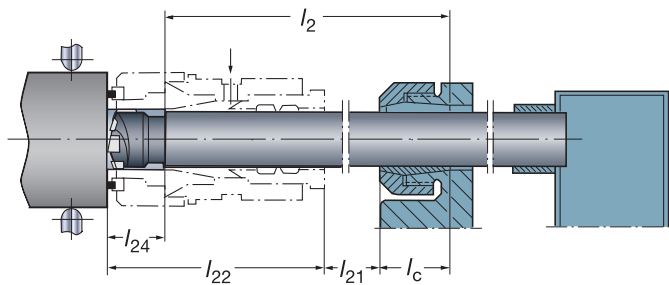

- $l_2$  = Overall length of drill tube
- $l_{24}$  = End of drill tube to tip of central insert
- $l_{22}$  = Overall length of oil pressure head
- $l_{21}$  = Hole depth
- $l_c$  = Drill tube clamping length

$l_2 = l_{22} + l_{21} + l_c - l_{24}$  = overall length of drill tube (including thread).  
**IMPORTANT:** If drill tube steady rests are used be sure to add their overall length to  $l_2$ .

Add length of vibration damper to the equation if one is required. Refer to page 76 for dimensions.

Solid drill heads 420.6 and 800.20			
Drill 420.6 Diameter range, mm		Drill 800.20 Diameter range, mm	$\leq$ $l_{24}$
$D_c$ mm	$l_{24}$	$D_c$ mm	
15,60–17,70	22,0	25,00–26,40	49,0
17,71–20,00	25,0	26,41–28,70	49,0
20,01–21,80	27,5	28,71–31,00	51,0
21,81–24,10	30,0	31,01–36,20	56,0
24,11–28,70	31,5	36,21–39,60	59,0
28,71–36,20	34,5	39,61–47,00	64,0
36,21–43,00	37,5	47,01–51,70	74,0
43,01–51,70	39,0	51,71–56,20	80,0
51,71–56,20	42,0	56,21–65,00	85,0
56,21–65,00	44,0		

T-Max adjustable solid drill heads A424.10 and 424.10		
Diameter range, mm	$l_{24}$	
$D_c$ mm		
63,50– 71,45	75	<b>Standard drills</b>
75,00– 76,20	85	
80,00– 95,25	93	
100,00–110,00	98	
114,30–130,00	102	
130,01–183,90		<b>Tailor Made drills</b>

To request a quotation, please specify drill diameter, depth of hole and machine tool type. To discuss your application, please contact your nearest Sandvik representative.

# T-MAX® 424.31F and 424.31 counterboring heads

The productivity and precision single insert counterboring heads

Diameter range 20,00- 278,99 mm

### Strong cartridges

Designed to protect from damage.

- Easy to change
- Good economy

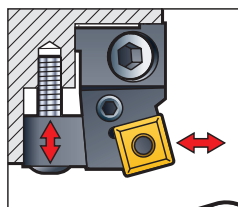

### Built-in precision

- Radial adjustment



### Excellent hole straightness and surface finish

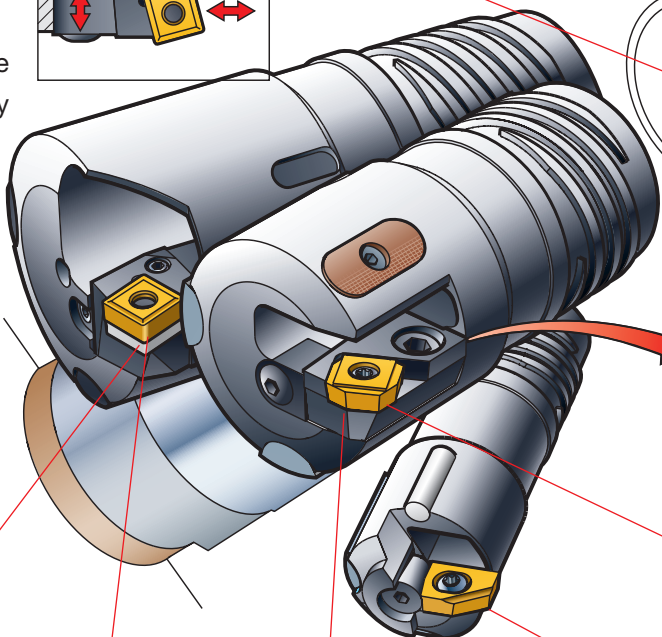

### Adjustable peripheral cartridge

- Easier radial setting
- Short setting time
- Improved precision

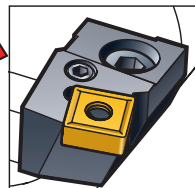

### Precision

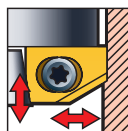

**424.31F**  
Dia. range  
20,00–43,00 mm  
 $a_p = 3$  mm  
Tol. IT9



**424.31F**  
Dia. range  
43,01–124,00 mm  
 $a_p = 4,5$  mm  
Tol. IT9

### Productivity



**424.31**  
TPxx insert  
Dia. range  
65,00–180,00 mm  
 $a_p = 12-17$  mm  
Tol. IT10

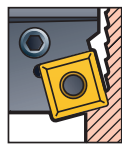

**424.31**  
SNxx insert  
Dia. range  
65,00–180,00 mm  
 $a_p = 10-16$  mm  
Tol. IT10

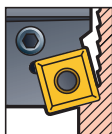

**424.31F**  
SNxx insert  
Dia. range  
43,01–124,00 mm  
 $a_p = 6$  mm  
Tol. IT10

### Machining economy

- Insert grades for counterboring in most materials.
- Insert types, sizes and geometries to get higher productivity, closer hole tolerances and higher surface finish.

### Note!

For applications requiring radial cut depths above 17 mm we recommend 424.32, see page 71.

# T-MAX® 424.31F and 424.31 counterboring heads

*Designed for precision, productivity and versatility*

- **Stocked standard components**
- **A complement to solid drilling**
  - for final diameter and surface finish operations
  - to extend hole diameter when machine power is limited.

*The same tube can normally be used*
- **Wide range of engineered solutions**

**424.31F**

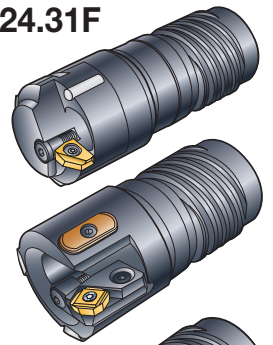

**424.31**

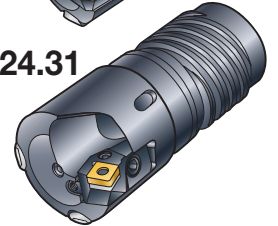

## Preferred STS applications

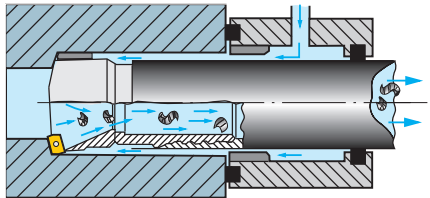

- Special machines for mass production
- Special DHD machines
- Long run production
- Long workpieces
- Material with difficult chipbreaking or uneven structure
- Stainless and low carbon steel

## Typical components – Industry segments

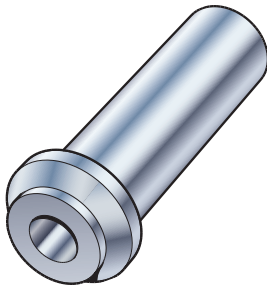

### Shaft

Bore dia,  $D_C$  : 102,50 mm  
Drill depth,  $l_4$  : 1200 mm

### Steel industry

- Billets

### Process industry

- Oil holes

### Aerospace industry

- Landing gear

### Ship yard

- Propeller axles
- Push rods

### Defence industry

- Barrels

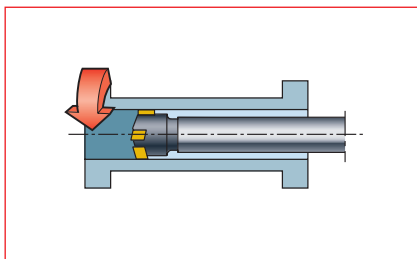

### Shaft

Bore dia,  $D_C$  : 227,00 mm (220,00 mm)  
Drill depth,  $l_4$  : 12025 mm

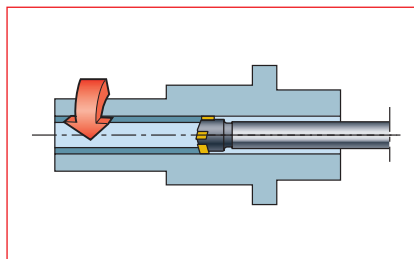

### Rotor shaft

Bore dia,  $D_C$  : 70,00 mm (50,00 mm)  
Drill depth,  $l_4$  : 600 mm

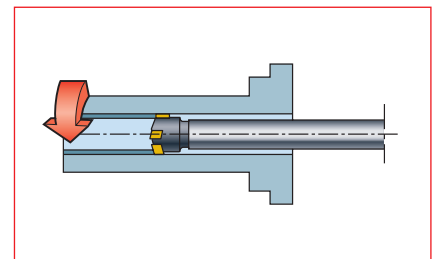

### Axle

Bore dia,  $D_C$  : 68,00 mm (50,00 mm)  
Drill depth,  $l_4$  : 1200,00 mm

**T-MAX® counterboring head 424.31F –  
manufactured by customer request**  
Single indexable insert design – close tolerance  
Diameter range 20,00 – 43,00 mm

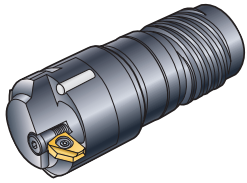

**Diameter range:** 20,00–43,00 mm  
**Hole depth:** 150 × diameter  
**Hole tolerance:** IT 9  
**Surface finish:**  $R_a$  1  $\mu$ m  
**Cutting fluid:** Neat oil or emulsion with EP-additives

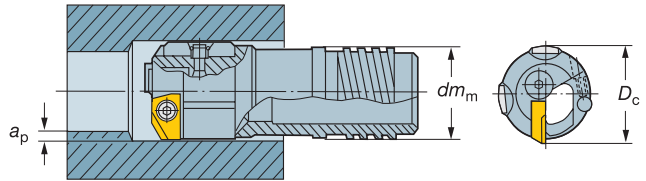

$dm_m$  is the same as  $dm_t$  for the drill tube

Diameter range, mm	Max. cutting depth	Inserts <sup>1)</sup>	Support pad set	Pressure pad set
$D_c$ mm	$a_p$ mm	R424.31F 	No.	No.
20,00–22,99	3,0	04	430.21 -06 D20,0 2	5636 010-011 1
23,00–25,99	3,0	04	430.21 -06 D23,0 2	5636 010-011 1
26,00–31,00	3,0	04	430.21 -06 D26,0 2	5636 010-011 1
31,01–33,99	3,0	04	430.21 -08 D31,0 2	5636 010-021 1
34,00–37,99	3,0	04	430.21 -08 D34,0 2	5636 010-021 1
38,00–43,00	3,0	04	430.21 -08 D38,0 2	5636 010-021 1

<sup>1)</sup> Inserts are ordered separately.

Ordering example: 2 pieces 430.21-06 D20,0

**Ordering**

When ordering counterboring heads the following must be stated:

- Drill diameter,  $D_c$ .
- Depth of cut or pre-bored size.
- Cartridges to be used – cartridge for close tolerances or for normal tolerances.
- Drilling system to be used – Ejector or STS.
- Drill tubes to be used and size  $dm_t$ .

**For more information and advice, please contact your nearest Sandvik representative.**

Counterboring head

Drill tube 420.5-

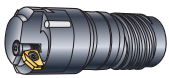

424.31F  
Diameter range  
20,00–43,00 mm

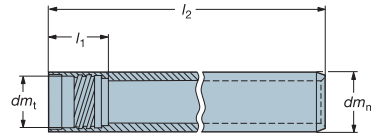

$dm_t$  is the same as  $dm_m$  for the drill

Diameter range, mm $D_c$ mm	Tube range	Ordering code Drill tube <sup>1)</sup>	Dimensions, mm				
			Standard length $l_2$		$dm_m$	$dm_t$	$l_1$
			1600	2600			
20,00-22,99	00	420.5-800-	2	–	17	15,5	22
	01	420.5-801-	–	4	18	16	25
	02	420.5-802-	–	4	20	18	26
23,00-25,99	02	420.5-802-	–	4	20	18	26
	03	420.5-803-	–	4	22	19,5	26
26,00-31,00	03	420.5-803-	–	4	22	19,5	26
	04	420.5-804-	–	4	24	21	26
	05	420.5-805-	–	4	26	23,5	29
31,01-33,99	06	420.5-806-	–	4	28	25,5	29
	07	420.5-807-	–	4	30	28	29
34,00-37,99	07	420.5-807-	–	4	30	28	29
	08	420.5-808-	–	4	33	30	36
38,00-43,00	08	420.5-808-	–	4	33	30	36
	09	420.5-809-	–	4	36	33	36

<sup>1)</sup> Other lengths can be manufactured by customer request, see page 61.

Ordering example for drill tube length 1600 mm fitting drill head  $D_c = 20,00$  mm:

**1 piece 420.5-800-2**

Ordering example for drill tube, design to customer request, length 400 mm fitting drill head  $D_c = 23,01$  mm:

**1 piece 420.5-802-L400**

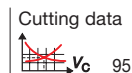
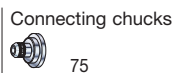



**T-MAX® counterboring head 424.31F – manufactured by customer request**  
**Single indexable insert design – close and normal tolerances**  
**Diameter range 43,01 – 124,99 mm**

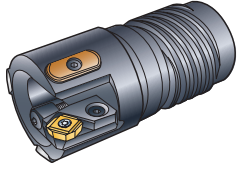

**Diameter range:** 43,01–124,99 mm  
**Hole depth:** 150 × diameter  
**Hole tolerance:** IT 9 or IT 10  
**Surface finish:**  $R_a$  1  $\mu$ m  
**Cutting fluid:** Neat oil or emulsion with EP-additives

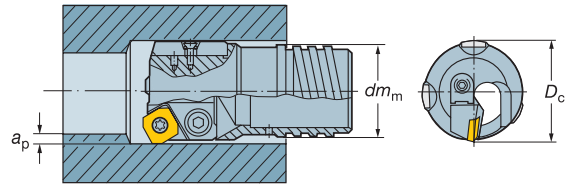

$dm_m$  is the same as  $dm_t$  for the drill tube

Diameter range, mm	Cartridge	Max. cutting depth	Inserts <sup>1)</sup>	Cartridge	Max. cutting depth	Inserts <sup>1)</sup>	Support pad set		Pressure pad set	
							No.	No.	No.	No.
$D_c$ mm		$a_p$ mm	R424.31F 		$a_p$ mm	SNMG SNMM 				
43,01– 46,99	R430.24-1118-06	4,5	06	R430.24-1018-09	6,0	09	430.21-10 D43,0	2	5636 020-011	1
47,00– 51,99	R430.24-1118-06	4,5	06	R430.24-1018-09	6,0	09	430.21-10 D47,0	2	5636 020-011	1
52,00– 57,99	R430.24-1118-06	4,5	06	R430.24-1018-09	6,0	09	430.21-10 D52,0	2	5636 020-011	1
58,00– 65,00	R430.24-1118-06	4,5	06	R430.24-1018-09	6,0	09	430.21-10 D58,0	2	5636 020-011	1
65,00– 69,99	R430.24-1118-06	4,5	06	R430.24-1018-09	6,0	09	430.21-12 D65,0	2	420.37-410-01	3
70,00– 74,99	R430.24-1118-06	4,5	06	R430.24-1018-09	6,0	09	430.21-12 D70,0	2	420.37-410-01	3
75,00– 79,99	R430.24-1118-06	4,5	06	R430.24-1018-09	6,0	09	430.21-12 D75,0	2	420.37-410-01	3
80,00– 84,99	R430.24-1118-06	4,5	06	R430.24-1018-09	6,0	09	430.21-12 D80,0	2	420.37-415-01	3
85,00– 89,99	R430.24-1118-06	4,5	06	R430.24-1018-09	6,0	09	430.21-12 D85,0	2	420.37-415-01	3
90,00– 94,99	R430.24-1118-06	4,5	06	R430.24-1018-09	6,0	09	430.21-16 D90,0	2	420.37-510-01	3
95,00– 99,99	R430.24-1118-06	4,5	06	R430.24-1018-09	6,0	09	430.21-16 D95,0	2	420.37-510-01	3
100,00–104,99	R430.24-1118-06	4,5	06	R430.24-1018-09	6,0	09	430.21-16 D100,0	2	420.37-510-01	3
105,00–109,99	R430.24-1118-06	4,5	06	R430.24-1018-09	6,0	09	430.21-16 D105,0	2	420.37-510-01	3
110,00–114,99	R430.24-1118-06	4,5	06	R430.24-1018-09	6,0	09	430.21-16 D110,0	2	420.37-510-01	3
115,00–119,99	R430.24-1118-06	4,5	06	R430.24-1018-09	6,0	09	430.21-16 D115,0	2	420.37-510-01	3
120,00–124,99	R430.24-1118-06	4,5	06	R430.24-1018-09	6,0	09	430.21-16 D120,0	2	420.37-510-01	3

<sup>1)</sup> Inserts are ordered separately.

Ordering example: 2 pieces R430.24-1118-06

**Ordering**

When ordering counterboring heads the following must be stated:

- Drill diameter,  $D_c$ .
- Depth of cut or pre-bored size.
- Cartridges to be used – cartridge for close tolerances or for normal tolerances.
- Drilling system to be used – Ejector or STS.
- Drill tubes to be used and size  $dm_t$ .

**For more information and advice, please contact your nearest Sandvik representative.**

Counterboring head

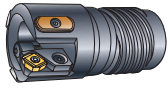

424.31F  
Diameter range  
43,01–124,99 mm

Drill tube 420.5-

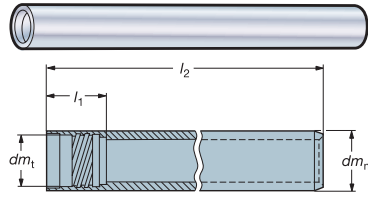

$dm_t$  is the same as  $dm_m$  for the drill

Diameter range, mm $D_c$ mm	Tube range	Ordering code Drill tube <sup>1)</sup>	Dimensions, mm			
			Standard length $l_2$	$dm_m$	$dm_t$	$l_1$
43,01-46,99	10	420.5-810-	4	39	36	36
47,00-51,99	11	420.5-811-	4	43	39	36
	12	420.5-812-	4	47	43	40
52,00-57,99	12	420.5-812-	4	47	43	40
	13	420.5-813-	4	51	47	40
58,00-65,00	13	420.5-813-	4	51	47	40
65,00-69,99	14	420.5-814-L <sup>1)</sup>	-	56	52	75
70,00-74,99	15	420.5-815-L <sup>1)</sup>	-	62	58	75
	16	420.5-816-L <sup>1)</sup>	-	68	63	75
75,00-79,99	16	420.5-816-L <sup>1)</sup>	-	68	63	75
80,00-84,99	17	420.5-817-L <sup>1)</sup>	-	75	70	97
85,00-89,99	17	420.5-817-L <sup>1)</sup>	-	75	70	97
	18	420.5-818-L <sup>1)</sup>	-	82	77	97
90,00-94,99	18	420.5-818-L <sup>1)</sup>	-	82	77	97
95,00-99,99	18	420.5-818-L <sup>1)</sup>	-	82	77	97
100,00-104,99	19	420.5-819-L <sup>1)</sup>	-	94	89	97
105,00-109,99	19	420.5-819-L <sup>1)</sup>	-	94	89	97
110,00-114,99	19	420.5-819-L <sup>1)</sup>	-	94	89	97
	20	420.5-820-L <sup>1)</sup>	-	106	101	118
115,00-119,99	20	420.5-820-L <sup>1)</sup>	-	106	101	118
120,00-124,99	20	420.5-820-L <sup>1)</sup>	-	106	101	118
	21	420.5-821-L <sup>1)</sup>	-	118	113	118

<sup>1)</sup> Lengths are manufactured by customer request, see page 61.

Ordering example for drill tube length 2600 mm fitting drill head  $D_c = 43,01$  mm:

**1 piece 420.5-810-4**

Ordering example for drill tube, design to customer request, length 400 mm fitting drill head  $D_c = 52,00$  mm:

**1 piece 420.5-812-L400**

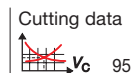

### T-MAX® counterboring head 424.31 – manufactured by customer request

Single indexable insert design  
Diameter range ≥ 65,00 mm

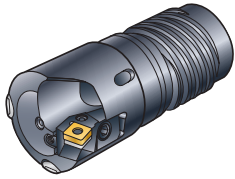

**Diameter range:** 65,00 – Max dia is dependent on machine capacity  
**Hole depth:** 150 × diameter  
**Hole tolerance:** IT 10  
**Surface finish:** R<sub>a</sub> 3 μm  
**Cutting fluid:** Neat oil or soluble with EP-additives

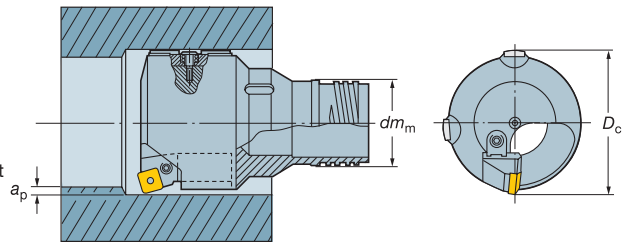

$dm_m$  is the same as  $dm_t$  for the drill tube

Diameter range, mm	T-Max P cartridge	Max. cutting depth	Inserts (Ordered separately)	T-Max S cartridge	Max. cutting depth	Inserts (Ordered separately)	Support pad set	
							No.	No.
$D_c$ mm		$a_p$ mm	SNMG SNMM		$a_p$ mm	TPMX TPUN <sup>2)</sup>		
65,00– 69,99	R430.24-2024-12	10	12	R430.23-2024-16	12	16	430.21-12 D65,0	2
70,00– 74,99	R430.24-2024-12	10	12	R430.23-2024-16	12	16	430.21-12 D70,0	2
75,00– 79,99	R430.24-2024-12	10	12	R430.23-2024-16	12	16	430.21-12 D75,0	2
80,00– 84,99	R430.24-2024-12	10	12	R430.23-2024-16	12	16	430.21-12 D80,0	2
85,00– 89,99	R430.24-2024-12	10	12	R430.23-2024-16	12	16	430.21-12 D85,0	2
90,00– 94,99	R430.24-2532-19 <sup>1)</sup>	16	19	R430.23-2532-22 <sup>1)</sup>	17	22	430.21-16 D90,0	2
95,00– 99,99	R430.24-2532-19 <sup>1)</sup>	16	19	R430.23-2532-22 <sup>1)</sup>	17	22	430.21-16 D95,0	2
100,00–104,99	R430.24-2532-19 <sup>1)</sup>	16	19	R430.23-2532-22 <sup>1)</sup>	17	22	430.21-16 D100,0	2
105,00–109,99	R430.24-2532-19 <sup>1)</sup>	16	19	R430.23-2532-22 <sup>1)</sup>	17	22	430.21-16 D105,0	2
110,00–114,99	R430.24-2532-19 <sup>1)</sup>	16	19	R430.23-2532-22 <sup>1)</sup>	17	22	430.21-18 D110,0	2
115,00–119,99	R430.24-2532-19 <sup>1)</sup>	16	19	R430.23-2532-22 <sup>1)</sup>	17	22	430.21-18 D115,0	2
120,00–124,99	R430.24-2532-19 <sup>1)</sup>	16	19	R430.23-2532-22 <sup>1)</sup>	17	22	430.21-18 D120,0	2
125,00–129,99	R430.24-2532-19 <sup>1)</sup>	16	19	R430.23-2532-22 <sup>1)</sup>	17	22	430.21-18 D125,0	2
130,00–139,99	R430.24-2532-19 <sup>1)</sup>	16	19	R430.23-2532-22 <sup>1)</sup>	17	22	430.21-18 D130,0	2
140,00–149,99	R430.24-2532-19 <sup>1)</sup>	16	19	R430.23-2532-22 <sup>1)</sup>	17	22	430.21-18 D140,0	2
150,00–159,99	R430.24-2532-19 <sup>1)</sup>	16	19	R430.23-2532-22 <sup>1)</sup>	17	22	430.21-18 D150,0	2
160,00–169,99	R430.24-2532-19 <sup>1)</sup>	16	19	R430.23-2532-22 <sup>1)</sup>	17	22	430.21-18 D160,0	2
170,00–179,99	R430.24-2532-19 <sup>1)</sup>	16	19	R430.23-2532-22 <sup>1)</sup>	17	22	430.21-18 D170,0	2
180,00–189,99	R430.24-2532-19 <sup>1)</sup>	16	19	R430.23-2532-22 <sup>1)</sup>	17	22	430.21-18 D180,0	2
190,00–199,99	R430.24-2532-19 <sup>1)</sup>	16	19	R430.23-2532-22 <sup>1)</sup>	17	22	430.21-18 D190,0	2
200,00–224,99	R430.24-2532-19 <sup>1)</sup>	16	19	R430.23-2532-22 <sup>1)</sup>	17	22	430.21-18 D200,0	2
225,00–249,99	R430.24-2532-19 <sup>1)</sup>	16	19	R430.23-2532-22 <sup>1)</sup>	17	22	430.21-18 D225,0	2
250,00–278,99	R430.24-2532-19 <sup>1)</sup>	16	19	R430.23-2532-22 <sup>1)</sup>	17	22	430.21-18 D250,0	2

1) For small cutting depth use cartridges R430.24-2024-12 or R430.23-2024-16. Must be stated in order.

2) Loose chipbreakers are to be used see page 102.

**Note!** for radial adjustment, see page 78.

When ordering additional support pads, D and the drilling diameter must be specified in the ordering code.

**Ordering example for cartridge for counterboring head**

∅ 65 mm: 1 piece R430.24-2024-12

**Ordering example for support pad for counterboring head**

∅ 65 mm: 1 piece 430.21-12 D65,0

Counterboring head



424.31  
Diameter range  
≥ 65,00 mm

Drill tube 420.5- (Tube range 14–26)

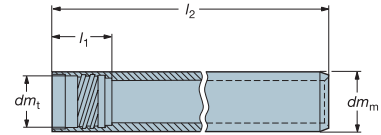

Drill tube 420.5- (Tube range 27–33)

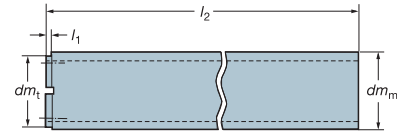

$dm_t$  is the same as  $dm_m$  for the drill

Diameter range, mm $D_c$ mm	Tube range	Ordering code Drill tube <sup>1)</sup>	Dimensions, mm		
			$dm_m$	$dm_t$	$l_1$
65,00-69,99	14	420.5-814-L <sup>1)</sup>	56	52	75
70,00-74,99	15	420.5-815-L <sup>1)</sup>	62	58	75
75,00-79,99	16	420.5-816-L <sup>1)</sup>	68	63	75
80,00-84,99	17	420.5-817-L <sup>1)</sup>	75	70	97
85,00-89,99	17	420.5-817-L <sup>1)</sup>	75	70	97
	18	420.5-818-L <sup>1)</sup>	82	77	97
90,00-94,99	18	420.5-818-L <sup>1)</sup>	82	77	97
95,00-99,99	18	420.5-818-L <sup>1)</sup>	82	77	97
100,00-104,99	19	420.5-819-L <sup>1)</sup>	94	89	97
105,00-109,99	19	420.5-819-L <sup>1)</sup>	94	89	97
110,00-114,99	19	420.5-819-L <sup>1)</sup>	94	89	97
	20	420.5-820-L <sup>1)</sup>	106	101	118
115,00-119,99	20	420.5-820-L <sup>1)</sup>	106	101	118
120,00-124,99	20	420.5-820-L <sup>1)</sup>	106	101	118
	21	420.5-821-L <sup>1)</sup>	118	113	118
125,00-129,99	21	420.5-821-L <sup>1)</sup>	118	113	118
130,00-139,99	21	420.5-821-L <sup>1)</sup>	118	113	118
	22	420.5-822-L <sup>1)</sup>	130	125	118
140,00-149,99	22	420.5-822-L <sup>1)</sup>	130	125	118
	23	420.5-823-L <sup>1)</sup>	142	137	139
150,00-159,99	23	420.5-823-L <sup>1)</sup>	142	137	139
160,00-169,99	24	420.5-824-L <sup>1)</sup>	154	149	139
170,00-179,99	24	420.5-824-L <sup>1)</sup>	154	149	139
	25	420.5-825-L <sup>1)</sup>	166	161	139
180,00-189,99	25	420.5-825-L <sup>1)</sup>	166	161	139
	26	420.5-826-L <sup>1)</sup>	178	173	144
190,00-199,99	26	420.5-826-L <sup>1)</sup>	178	173	144
	27	420.5-827-L <sup>1)</sup>	190	172	8
200,00-224,99	27	420.5-827-L <sup>1)</sup>	190	172	8
	28	420.5-828-L <sup>1)</sup>	202	184	8
	29	420.5-829-L <sup>1)</sup>	214	196	8
225,00-249,99	29	420.5-829-L <sup>1)</sup>	214	196	8
	30	420.5-830-L <sup>1)</sup>	226	208	8
	31	420.5-831-L <sup>1)</sup>	238	220	8
250,00-278,99	31	420.5-831-L <sup>1)</sup>	238	220	8
	32	420.5-832-L <sup>1)</sup>	250	232	8
	33	420.5-833-L <sup>1)</sup>	262	244	8

**Ordering**  
When ordering counterboring heads the following must be stated:

- Drill diameter,  $D_c$ .
- Depth of cut or pre-bored size.
- Insert clamping system to be used – T-Max P lever or T-Max S top clamp.
- Drilling system to be used – Ejector or STS.
- Drill tubes to be used and size  $dm_t$ .

**For more information and advice, please contact your nearest Sandvik representative.**

<sup>1)</sup> Lengths are manufactured by customer request, see page 61.

Ordering example for drill tube, design to customer request, length 400 mm fitting drill head  $D_c = 65,00$  mm:

1 piece 420.5-814-L400

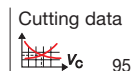

### T-MAX<sup>®</sup> trepanning head 420.7 – manufactured by customer request

Indexable insert design  
Diameter range  
112,00 – 250,00 mm

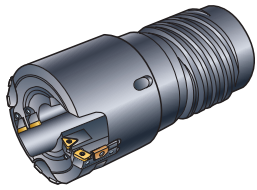

**Diameter range:** 112,00–250,00 mm  
**Hole depth:** 150 × Dia.  
**Hole tolerance:** IT 10  
**Surface finish:** R<sub>a</sub> 3 μm  
**Cutting fluid:** Neat oil or soluble

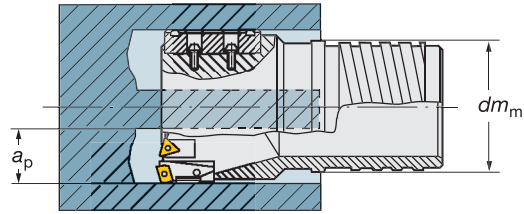

$d_{m_m}$  is the same as  $d_{m_t}$  for the drill tube

Diameter range, mm $D_c$ mm	Cartridges			Support pad	No.	$a_p$ mm	
	Central	No.	Peripheral				No.
112,00–119,99	L430.27-1216-16	3	R430.28-1516-16	1	(on request)	2	43,75
120,00–124,99	L430.27-1216-16	3	R430.28-1516-16	1	430.21-18D120.0	2	43,75
125,00–129,99	L430.27-1216-16	3	R430.28-1516-16	1	430.21-18D125.0	2	43,75
130,00–139,99	L430.27-1216-16	3	R430.28-1516-16	1	430.21-18D130.0	2	43,75
140,00–149,99	L430.27-1216-16	3	R430.28-1516-16	1	430.21-18D140.0	2	43,75
150,00–159,99	L430.27-1216-16	3	R430.28-1516-16	1	430.21-18D150.0	2	43,75
160,00–179,99	L430.27-1216-16	3	R430.28-1516-16	1	430.21-18D160.0	2	43,75
180,00–195,99	L430.27-1216-16	3	R430.28-1516-16	1	430.21-18D180.0	2	43,75
196,00–224,99	L430.27-1216-16	4	R430.28-1516-16	1	430.21-18D200.0	2	53,75
225,00–249,99	L430.27-1216-16	4	R430.28-1516-16	1	430.21-18D225.0	2	53,75
250,00	L430.27-1216-16	4	R430.28-1516-16	1	430.21-18D250.0	2	53,75

**Note!** for radial adjustment, see page 78.

#### Ordering

When ordering trepanning heads the following must be stated:

- Drill diameter,  $D_c$ .

**For more information and advice, please contact your nearest Sandvik representative.**

Inserts (Ordered separately)					
Central cartridge	Insert	Peripheral cartridge	Insert		
L430.27-1216-16	16 16 TPMT 16T312R-22 TPMT 16T312TR-23	R430.28-1516-16	13 13 R424.9-13T308-22 R424.9-13T308-23		

Inserts 83, 85	Vibration dampers 76	Oil pressure heads 74	Connecting chucks 75	Spare parts 103	Cutting data $v_c$ 97	Application guide 117
-------------------	-------------------------	--------------------------	-------------------------	--------------------	--------------------------	--------------------------



**T-MAX<sup>®</sup> counterboring head 424.32 –  
manufactured by customer request**

**Multi-indexable insert design  
Diameter range  $\geq 75,00$  mm**

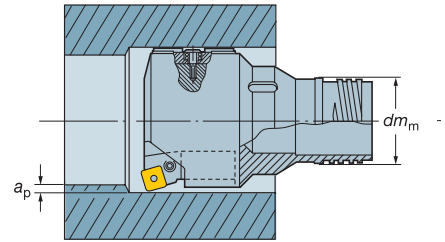

$dm_m$  is the same as  $dm_t$  for the drill tube

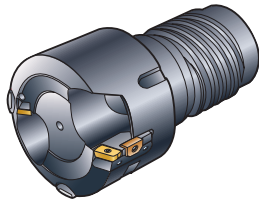

<b>Diameter range:</b>	75,00 – upwards Max. dia is dependent on machine capacity
<b>Hole depth:</b>	150 × diameter
<b>Hole tolerance:</b>	IT 10
<b>Surface finish:</b>	$R_a$ 3 $\mu$ m
<b>Cutting fluid:</b>	Neat oil or emulsion with EP-additives
<b>Max cutting depth <math>a_p</math>:</b>	From diameter 75,00, $a_p = 30$ mm From diameter 99,99, $a_p = 40$ mm From diameter 120,00, $a_p = 50$ mm From diameter 160,00, $a_p = 67$ mm

**Note!** for radial adjustment, see page 78.

**Adjustable Counterboring head –  
manufactured by customer request**

**Multi-indexable insert design,  
Preferably for STS drills  
Diameter range  $\geq 100,00$  mm**

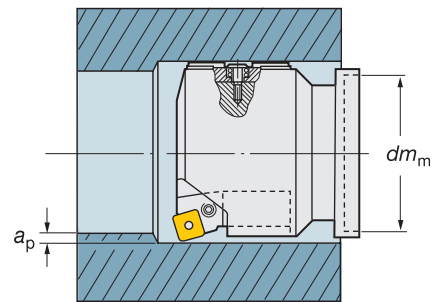

$dm_m$  is the same as  $dm_t$  for the drill tube



<b>Diameter range:</b>	100,00 – upwards Max. dia is dependent on machine capacity
<b>Diameter increasing:</b>	10 – 120 mm depending on diameter, by fitting shims behind pad blocks and cassettes
<b>Hole depth:</b>	150 × diameter
<b>Hole tolerance:</b>	IT 10
<b>Surface finish:</b>	$R_a$ 3 $\mu$ m
<b>Cutting fluid:</b>	Neat oil or emulsion with EP-additives
<b>Cutting depth <math>a_p</math>:</b>	5 – 60 mm depending on diameter

**Ordering**

When ordering above counterboring heads the following must be stated:

- Drill diameter,  $D_C$
- Adjustability range, *only for adjustable counterboring head*
- Drilling system to be used – Ejector or STS
- Depth of cut or pre-bored size
- Drill tubes to be used and size  $dm_t$

**For more information and advice, please contact your nearest Sandvik representative.**

Inserts



Vibration dampers



Oil pressure heads



Connecting chucks



Spare parts



Cutting data



Application guide





### Mounting parts for connectors, diameter range 15,60 – 327,90

Diameter range, mm	Tube range	Oil pressure head <sup>1)</sup>		Vibration <sup>1)</sup> damper		Connecting chucks <sup>1)</sup>	
		With clamping cones For non-rotating and rotating workpieces	For face sealing only. Without clamping cones For non-rotating and rotating workpieces	Collet style for drill diameter	Split bush for drill diameter		
D <sub>c</sub> mm		Non-rotating	Rotating	Non-rotating	Rotating	15,60–65,00 mm	51,71–327,90 mm
15,60– 16,70	97	420.9S/505	420.9S/500	420.9S/510	420.9S/515	342-0937-1	420.9S/524 –
16,71– 17,70	98	420.9S/505	420.9S/500	420.9S/510	420.9S/515	342-0937-1	420.9S/524 –
17,71– 18,90	99	420.9S/505	420.9S/500	420.9S/510	420.9S/515	342-0937-1	420.9S/524 –
18,91– 20,00	00	420.9S/505	420.9S/500	420.9S/510	420.9S/515	342-0937-1	420.9S/524 –
20,01– 21,80	01	420.9S/505	420.9S/500	420.9S/510	420.9S/515	342-0937-1	420.9S/524 –
21,81– 24,10	02	420.9S/505	420.9S/500	420.9S/510	420.9S/515	342-0937-1	420.9S/524 –
24,11– 26,40	03	420.9S/505	420.9S/500	420.9S/510	420.9S/515	342-0937-1	420.9S/524 –
26,41– 28,70	04	420.9S/505	420.9S/500	420.9S/510	420.9S/515	342-0937-1	420.9S/524 –
28,71– 31,00	05	420.9S/505	420.9S/500	420.9S/510	420.9S/515	342-0937-1	420.9S/524 –
31,01– 33,30	06	420.9S/505	420.9S/500	420.9S/510	420.9S/515	342-0937-1	420.9S/524 –
33,31– 36,20	07	420.9S/505	420.9S/500	420.9S/510	420.9S/515	342-0937-1	420.9S/524 –
36,21– 39,60	08	420.9S/505	420.9S/500	420.9S/510	420.9S/515	342-0937-1	420.9S/524 –
39,61– 43,00	09	420.9S/505	420.9S/500	420.9S/510	420.9S/515	342-0937-1	420.9S/524 –
43,01– 47,00	10	420.9S/506	420.9S/501	420.9S/511	420.9S/516	342-0937-1	420.9S/524 –
47,01– 51,70	11	420.9S/506	420.9S/501	420.9S/511	420.9S/516	342-0937-1	420.9S/524 –
51,71– 56,20	12	420.9S/506	420.9S/501	420.9S/511	420.9S/516	342-0937-1	420.9S/524 420.9S/520
56,21– 65,00	13	420.9S/506	420.9S/501	420.9S/511	420.9S/516	342-0937-1	420.9S/524 420.9S/520
60,61– 65,00	13E	420.9S/506	420.9S/501	420.9S/511	420.9S/516	342-0937-1	420.9S/524 420.9S/520
65,00– 66,99	14	420.9S/506	420.9S/501	420.9S/511	420.9S/516	342-0937-1	420.9S/524 420.9S/520
67,00– 72,99	15	420.9S/506	420.9S/501	420.9S/511	420.9S/516	342-0937-1	– 420.9S/520
73,00– 79,99	16	420.9S/506	420.9S/501	420.9S/511	420.9S/516	342-0937-1	– 420.9S/520
80,00– 86,99	17	420.9S/507	420.9S/502	420.9S/512	420.9S/517	342-0938-1	– 420.9S/520
87,00– 99,99	18	420.9S/507	420.9S/502	420.9S/512	420.9S/517	342-0938-1	– 420.9S/520
100,00–111,99	19	420.9S/507	420.9S/502	420.9S/512	420.9S/517	342-0938-1	– 420.9S/520
112,00–123,99	20	420.9S/507	420.9S/502	420.9S/512	420.9S/517	342-0938-1	– 420.9S/520
124,00–135,99	21	420.9S/507	420.9S/502	420.9S/512	420.9S/517	342-0938-1	– 420.9S/521
136,00–147,90	22	420.9S/507	420.9S/502	420.9S/512	420.9S/517	342-0938-1	– 420.9S/521
148,00–159,90	23	420.9S/507	420.9S/502	420.9S/512	420.9S/517	342-0938-1	– 420.9S/521
160,00–171,90	24	420.9S/508	420.9S/503	420.9S/513	420.9S/518	342-0939-1	– 420.9S/521
172,00–183,90	25	420.9S/508	420.9S/503	420.9S/513	420.9S/518	342-0939-1	– 420.9S/521
184,00–195,90	26	420.9S/508	420.9S/503	420.9S/513	420.9S/518	342-0939-1	– 420.9S/522
196,00–207,90	27	420.9S/508	420.9S/503	420.9S/513	420.9S/518	342-0939-1	– 420.9S/522
208,00–219,90	28	420.9S/508	420.9S/503	420.9S/513	420.9S/518	342-0939-1	– 420.9S/522
220,00–231,90	29	420.9S/508	420.9S/503	420.9S/513	420.9S/518	342-0939-1	– 420.9S/522
232,00–243,90	30	420.9S/508	420.9S/503	420.9S/513	420.9S/518	342-0939-1	– 420.9S/522
244,00–255,90	31	420.9S/508	420.9S/503	420.9S/513	420.9S/518	–	– 420.9S/522
256,00–267,90	32	420.9S/509	420.9S/504	420.9S/514	420.9S/519	–	– 420.9S/523
268,00–279,90	33	420.9S/509	420.9S/504	420.9S/514	420.9S/519	–	– 420.9S/523
280,00–291,90	34	420.9S/509	420.9S/504	420.9S/514	420.9S/519	–	– 420.9S/523
292,00–303,90	35	420.9S/509	420.9S/504	420.9S/514	420.9S/519	–	– 420.9S/523
304,00–315,90	36	420.9S/509	420.9S/504	420.9S/514	420.9S/519	–	– 420.9S/523
316,00–327,90	37	420.9S/509	420.9S/504	420.9S/514	420.9S/519	–	– 420.9S/523

<sup>1)</sup> Available on request.

Ordering example: 1 piece 420.9S/505



## STS oil pressure heads

For deep hole drilling with the Single Tube System, Sandvik Coromant offers a range of oil pressure heads for both rotating and non-rotating workpieces. The oil pressure head serves 4 major functions:

- Introduces coolant to the cutting tool.
- Seals against the face of the workpiece.
- Holds the drill bushing.
- Seals the external surface of the drill tube.

Oil pressure head act as clamping devices and also serve to self-centre the component.

**Type 1** would typically be used where the component cannot rotate but is symmetrical and can be machined to suit the conical clamping rings.

**Type 2** is generally used with symmetrical, high volume components which can be rotated.

**Type 3** oil pressure heads are used with unsymmetrical components which, for example, are fixtured on a workpiece table.

**Type 4** oil pressure heads may be used for symmetrical components which can rotate and be placed in steady rests and are generally used for lower volume production.

The above mentioned pressure heads cover diameters from 15,60 to 399,90 mm in five drill diameter ranges per type.

### Components

The conical clamping rings are manufactured according to the workpiece diameter. The sizes of the drill bushing, drill bushing holder, intermediate drill bushing holder, face seal ring, and 'O'-rings are determined by the tool diameter. If thin wall components must be drilled, the conical clamping ring, drill bushing, drill bushing holder, and intermediate drill bushing holder are of special design.

### Drill tube sealing

The outside diameter of the drill tube is sealed by means of the packing box at the rear of the oil pressure head. This packing box consists of the packing bushing, thrust rings, guide ring, threaded pressure nut, and flexible packing.

Sealing is accomplished by tightening the threaded pressure nut and forcing the flexible packing to seal around the drill tube. The locking screw ensures that the sealing pressure on the drill tube remains unchanged.

Packing boxes are purchased for each drill tube so that the entire assembly remains as one unit, which in effect means less changeover time.

### Alignment

- The pressure head must be mounted accurately to within 0,02 mm of the machine centre line, and seals kept in good condition to ensure efficient operation of the machine.
- It is recommended that the workpiece is supported with a steady, mounted as close as possible to the guide bush. The pressure head and the workpiece steady should be linked into one stable unit.

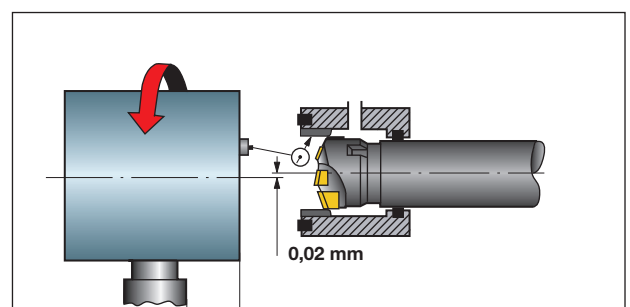
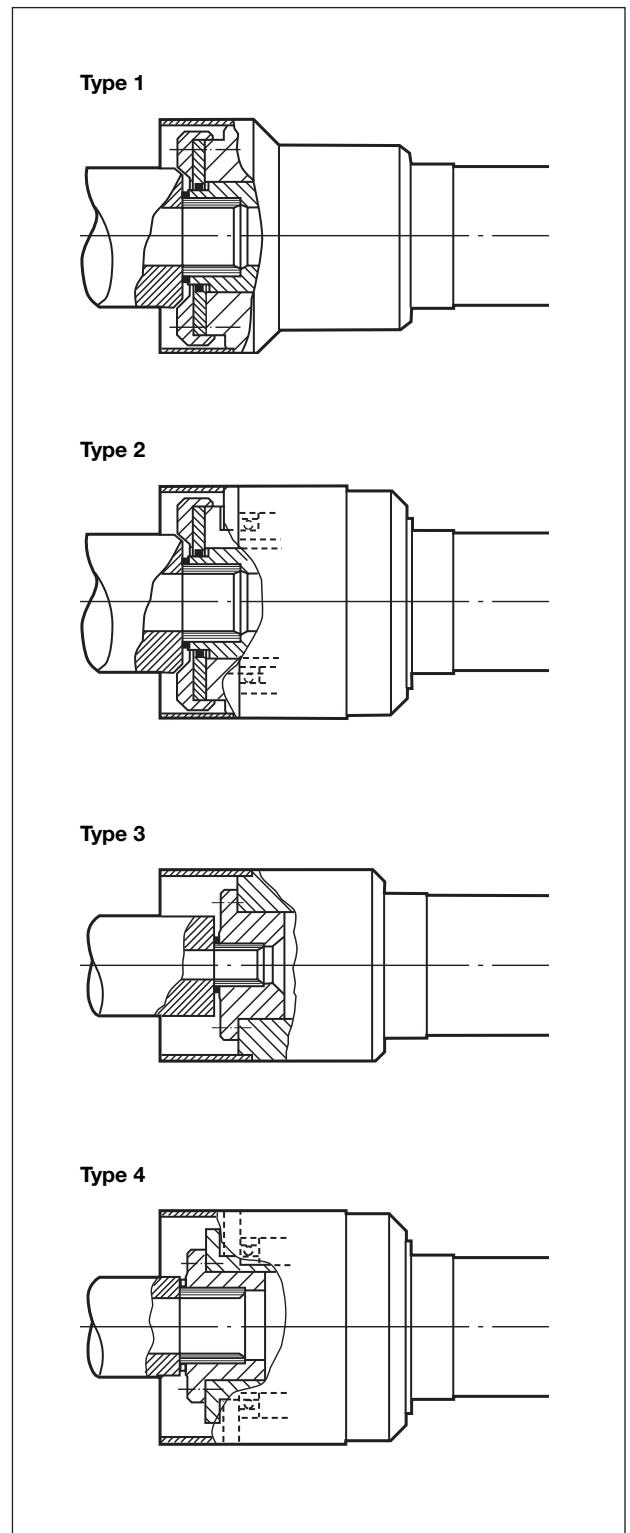

## STS oil pressure heads 420.9S

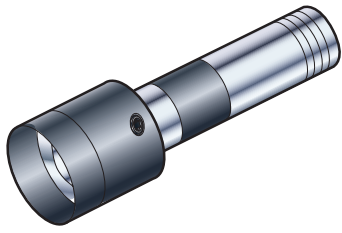

**Drill diameter:** 15,60-399,90 mm  
**Max spindle speed:**  $n$  r/min  
**Max coolant pressure:**  $p$  Mpa  
**Max clamping force:**  $F$  N  
**Permitted leakage:**  $q$  l/min  
**Temperature in oil pressure head:** 50-60° C

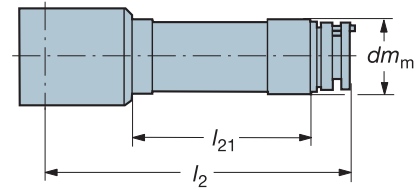

### For stationary workpieces

Type	Diameter range, mm	Ordering code	Dimensions, mm			Specifications		
	$D_c$ mm		$l_2$	$l_{21}$	$dm_m$	$p$	$F$	$q$
With clamping cones	15,60- 43,00	420.9S/505	466	250	100	6,0	5000	3
	43,01- 79,90	420.9S/506	531	250	140	3,0	7500	5
	80,00-159,90	420.9S/507	623	250	230	1,5	8500	7
	160,00-255,90	420.9S/508	715	300	355	1,2	10000	8
	256,00-399,90	420.9S/509	905	430	490	0,5	15000	12
For face sealing only without clamping cones	15,60- 43,00	420.9S/510	413	250	100	6,0	5000	3
	43,01- 79,90	420.9S/511	461	250	140	3,0	7500	5
	80,00-159,90	420.9S/512	526	250	230	1,5	8500	7
	160,00-255,90	420.9S/513	573	300	355	1,2	10000	8
	256,00-399,90	420.9S/514	715	430	490	0,5	15000	12

### For rotating workpieces

Type	Diameter range, mm	Ordering code	Dimensions, mm			Specifications			
	$D_c$ mm		$l_2$	$l_{21}$	$dm_m$	$n$	$p$	$F$	$q$
With clamping cones	15,60- 43,00	420.9S/500	466	250	100	1800	6,0	5000	3
	43,01- 79,90	420.9S/501	531	250	140	1200	2,0	7500	5
	80,00-159,90	420.9S/502	623	250	230	800	1,5	8500	7
	160,00-255,90	420.9S/503	715	300	355	350	1,2	10000	8
	256,00-399,90	420.9S/504	905	430	490	105	0,5	15000	12
For face sealing only without clamping cones	15,60- 43,00	420.9S/515	466	250	100	1800	6,0	5000	3
	43,01- 79,90	420.9S/516	527	250	140	1200	2,0	7500	5
	80,00-159,90	420.9S/517	623	250	230	800	1,5	8500	7
	160,00-255,90	420.9S/518	715	300	355	350	1,2	10000	8
	256,00-399,90	420.9S/519	905	430	490	105	0,5	15000	12

### Ordering

When ordering STS oil pressure heads the following must be stated:

- Ordering code for oil pressure head.
- Drill diameter,  $D_c$ .
- Drill tube diameter.
- Workpiece outer diameter.

**For more information and advice, please contact your nearest Sandvik representative.**

## STS connecting chucks

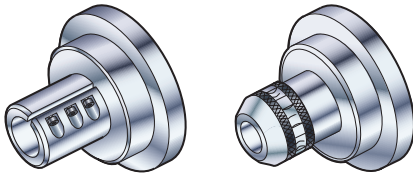

Connecting chucks are manufactured to customers request and designed to a specific STS drill tube. Chucks are available in a variety of spindle nose styles and sizes. Suitable for rotating as well as stationary tools. Bushes must be manufactured to suit each drill tube diameter used.

Type	Diameter range, mm $D_c$	Ordering code	Drill tube diameter, mm $dm_m$
<b>Collet style</b>	15,6– 65,0	<b>420.9S/524</b>	11 – 56
<b>Split bushing style</b>	51,7–123,9 124,0–183,9 184,0–255,9 256,0–399,9	<b>420.9S/520</b> <b>420.9S/521</b> <b>420.9S/522</b> <b>420.9S/523</b>	47 – 106 118 – 166 178 – 238 250 – 382

### Ordering

When ordering connecting chucks the following must be stated:

- Ordering code for connecting chuck.
- Information about spindle nose design.
- Drill tube diameter.

**For more information and advice, please contact your nearest Sandvik representative.**

### Vibration dampers

For Ejector and STS drills  
Diameter range 15,60 – 243,90 mm

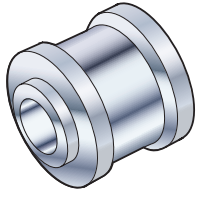

Vibrations not only affect the surface finish and shorten tool life, but also force changes in cutting data which result in production loss.

In order to control these vibrations better, Sandvik has designed a line of vibration dampers. These dampers are clamped externally to the drill tube and act as supports for the drill.

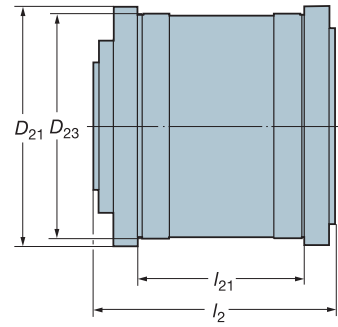

Diameter range, mm	Ordering code	Drill tube diameter, mm	Dimensions, mm			
			$l_2$	$l_{21}$	$D_{21}$	$D_{23}$
$D_c$ mm		$dm_m$				
15,60– 79,90	342-0937-1	11– 68	195	135	195	180
80,00–159,90	342-0938-1	75–142	254	165	300	280
160,00–243,90	342-0939-1	154–226	286	165	375	355

When ordering vibration dampers the following must be stated:

- Ordering code for vibration damper
- Drill tube diameter

**For more information and advice, please contact your nearest Sandvik representative.**

### Vibration dampers for rotating drills

The damper assembly is mounted in a steady-rest(s), normally supplied by the machine builder. The damping pressure can be adjusted by the use of a wrench on the thrust ring (item no. 6). Phenolic bushes for full contact are manufactured for each drill tube size and are slotted and tapered for maximum damping.

1. Body
2. Collet
3. Adjusting ring
4. Bearing
5. Pressure nut
6. Thrust ring

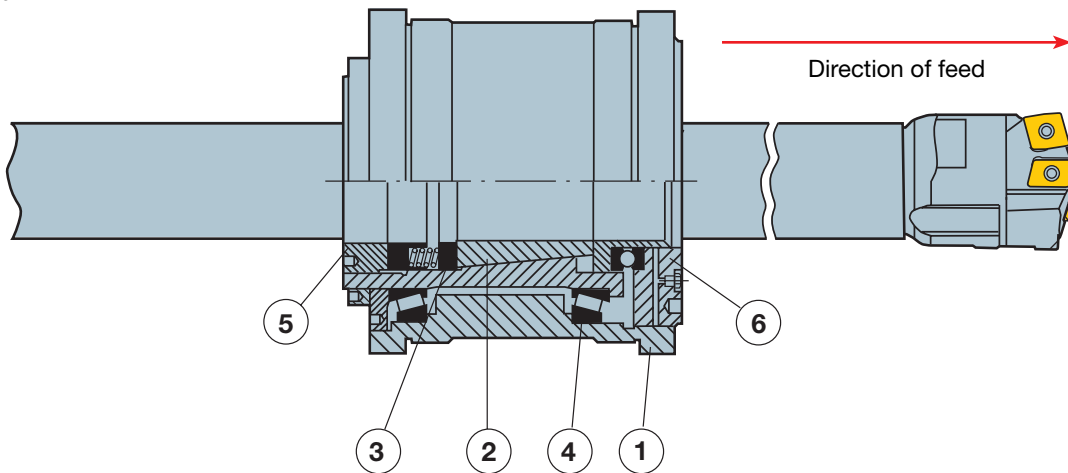

### Adaptors for converting from external to internal tube threads

(Available on request)

Diameter range: 20,00–65,00 mm  
420.9S/188-xx – STS 420.6, 800.20

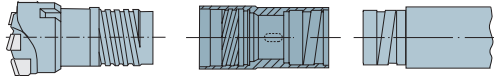

Diameter range: 65,00–195,90 mm  
420.9S/344-xx – Ejector T-Max 424.10, STS T-Max 424.10

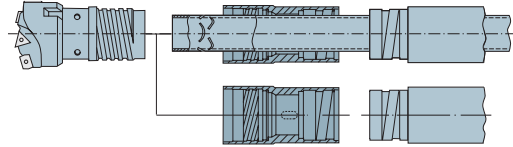

Diameter range: 20,00–65,00 mm  
420.9S/173-xx – Ejector 424.6, 800.24

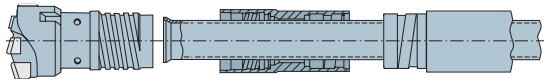

Diameter range: 196,00–363,90 mm  
420.9S/348-xx – STS T-Max special drilling and counterboring heads

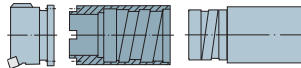

Diameter range: 20,00–65,00 mm  
420.9S/188-xx – STS 420.6, 800.20  
420.9S/173-xx – Ejector 424.6, 800.24

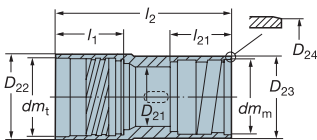

Diameter range: 65,00–195,90 mm  
420.9S/344-xx – STS T-Max 424.10  
Ejector T-Max 424.10

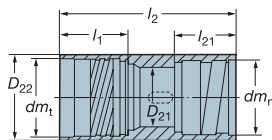

Diameter range: 196,00–363,90 mm  
420.9S/348-xx – STS T-Max special drilling and counterboring heads

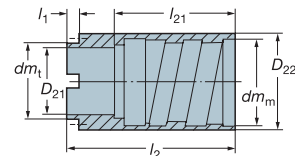

Adaptors are delivered with one-start square thread, the Heller-thread, in one end and an internal four-start square thread, the E-thread, in the other end.

Adaptors for drill diameters up to 195,9 mm are delivered with one-start square thread, the Heller-thread, in one end and an internal four-start square thread, the E-thread, in the other end.

Adaptors for drill diameters >196 mm are delivered with one-start square thread in one end and locations for flange mounting in the other end.

Diameter range, mm	Ordering code	Dimensions, mm							
		Ejector thread		BTA-thread		D <sub>c</sub> mm			
		dm <sub>t</sub>	l <sub>1</sub>	dm <sub>m</sub>	l <sub>21</sub>	D <sub>21</sub>	D <sub>22</sub>	D <sub>23</sub>	D <sub>24</sub> l <sub>2</sub>
<b>STS – 420.6, 800.20</b>									
20,00–21,80	420.9S/188-1	16	27,5	16,5	25	12,0	18,8	18,8	18 75
21,81–24,10	420.9S/188-2	18	30	19	25	13,0	21,0	21,0	20 78
24,11–26,40	420.9S/188-3	19,5	30	20	25	14,0	22,5	22,5	22 78
26,41–28,70	420.9S/188-4	21	30	22	25	15,5	24,6	24,6	24 78
28,71–31,00	420.9S/188-5	23,5	33	24	25	17,0	26,7	26,7	26 84
31,01–33,30	420.9S/188-6	25,5	33	26	25	18,5	28,8	28,8	28 84
33,31–36,20	420.9S/188-7	28	33	27	40	20,0	31,0	31,0	30 108
36,21–39,60	420.9S/188-8	30	40	30	40	23,0	33,8	33,8	33 108
39,61–43,00	420.9S/188-9	33	40	33	40	25,5	36,8	36,8	36 108
43,01–47,00	420.9S/188-10	36	40	37	40	28,0	40,6	40,6	39 108
47,01–51,70	420.9S/188-11	39	40	41	40	31,0	44,4	44,4	43 108
51,71–56,20	420.9S/188-12	43	44	44	40	35,0	48,6	48,6	47 114
56,21–65,00	420.9S/188-13	47	44	49	40	39,0	53,0	53,0	51 114
<b>Ejector – 424.6, 800.24</b>									
20,00–21,80	420.9S/173-1	18	30	16,5	25	12,0	19,5	18,8	18 78
21,81–24,10	420.9S/173-2	19,5	30	19	25	13,0	21,5	21,0	20 78
24,11–26,40	420.9S/173-3	21	30	20	25	14,0	23,5	22,5	22 78
26,41–28,70	420.9S/173-4	23,5	33	22	25	15,5	26,0	24,6	24 84
28,71–31,00	420.9S/173-5	25,5	33	24	25	17,0	28,0	26,7	26 84
31,01–33,30	420.9S/173-6	28	33	26	25	18,5	30,5	28,8	28 84
33,31–36,20	420.9S/173-7	30	40	27	40	20,0	33,0	31,0	30 108
36,21–39,60	420.9S/173-8	33	40	30	40	23,0	35,5	33,8	33 108
39,61–43,00	420.9S/173-9	36	40	33	40	25,5	39,0	36,8	36 108
43,01–47,00	420.9S/173-10	39	40	37	40	28,0	42,0	40,6	39 108
47,01–51,70	420.9S/173-11	43	44	41	40	31,0	46,0	44,4	43 114
51,71–56,20	420.9S/173-12	47	44	44	40	35,0	51,0	48,6	47 114
56,21–65,00	420.9S/173-13	51	44	49	40	39,0	55,0	53,0	51 114

Diameter range, mm	Ordering code	Dimensions, mm						
		Ejector thread		BTA-thread		D <sub>c</sub> mm		
		dm <sub>t</sub>	l <sub>1</sub>	dm <sub>m</sub>	l <sub>21</sub>	D <sub>21</sub>	D <sub>22</sub>	l <sub>2</sub>
<b>STS / Ejector – T-Max 420.10</b>								
65,00– 66,90	420.9S/344-14	52	75	53	40	43,0	56,0	135
67,00– 72,90	420.9S/344-15	58	75	59	40	48,0	62,0	135
73,00– 79,90	420.9S/344-16	63	75	65	70	53,0	68,0	165
80,00– 86,90	420.9S/344-17	70	97	71	70	59,0	75,0	190
87,00– 99,90	420.9S/344-18	77	97	79	70	66,0	82,0	190
100,00–111,90	420.9S/344-19	89	97	90	70	78,0	94,0	190
112,00–123,90	420.9S/344-20	101	118	102	70	90,0	106,0	215
124,00–135,90	420.9S/344-21	113	118	114	70	92,0	118,0	215
136,00–147,90	420.9S/344-22	125	118	126	70	104,0	130,0	215
148,00–159,90	420.9S/344-23	137	139	139	70	116,0	142,0	240
160,00–171,90	420.9S/344-24	149	139	151	85	128,0	154,0	255
172,00–183,90	420.9S/344-25	161	139	163	85	140,0	166,0	255
184,00–195,90	420.9S/344-26	173	144	175	85	152,0	178,0	265
<b>STS – T-Max special drilling and counterboring heads</b>								
196,00–207,90	420.9S/348-27	172	8	187	85	154,0	190,0	130
208,00–219,90	420.9S/348-28	184	8	199	85	166,0	202,0	130
220,00–231,90	420.9S/348-29	196	8	211	85	178,0	214,0	130
232,00–243,90	420.9S/348-30	208	8	223	85	190,0	226,0	130
244,00–255,90	420.9S/348-31	220	8	235	85	202,0	238,0	130
256,00–267,90	420.9S/348-32	232	8	247	120	214,0	250,0	165
268,00–279,90	420.9S/348-33	244	8	259	120	226,0	262,0	165
280,00–291,90	420.9S/348-34	256	8	271	120	238,0	274,0	165
292,00–303,90	420.9S/348-35	268	8	283	120	250,0	286,0	165
304,00–315,90	420.9S/348-36	280	8	295	120	262,0	298,0	165
316,00–327,90	420.9S/348-37	292	8	307	120	274,0	310,0	165
328,00–339,90	420.9S/348-38	304	8	319	120	286,0	322,0	165
340,00–351,90	420.9S/348-39	316	8	331	120	298,0	334,0	165
352,00–363,90	420.9S/348-40	328	8	343	120	310,0	346,0	165

Note! Adaptors for cross hole drilling are available on request.

Ordering example: 2 pieces 420.9S/188-1

## Setting deep hole drill head T-MAX® 424.10, 424.31, 424.32 and 420.7, from the nominal diameter upwards

1. Remove both support pads.

2. Check that the pad seats are free from burrs and dirt.

Choose shim for the appropriate pads. Shims, suitable for each size of pad, are available in thicknesses 0,1, 0,2 and 0,3 mm. Two sets of shims are required for each head. See page 100 for ordering. Shims in other thicknesses, to be manufactured locally.

3. Place the shims under the respective pad and tighten the lock screws.

4. The support pad located opposite the periphery insert, should first be mounted in its upper position to allow checking of the tool diameter. The other pad has only one fixed location as it is not in position for the measuring operation.

5. If necessary to adjust the diameter further, the position of the peripheral insert can easily be set by its cartridge setting screw. Tighten the cartridge clamping screw carefully.

Repeat the check of tool diameter after all setting or shim replacement operations.

6. Check the tool diameter with a micrometer.

7. Relocate the pad opposite the peripheral insert to its lower position and tighten its lock screw.

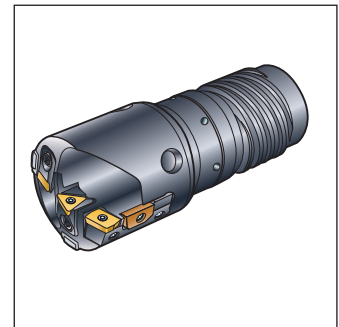
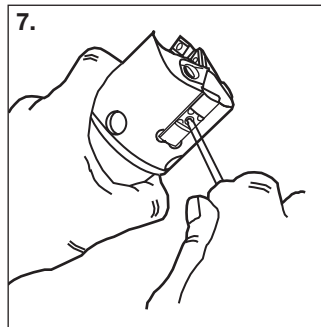
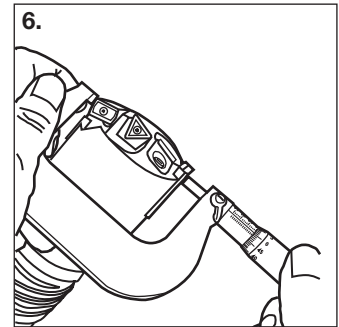
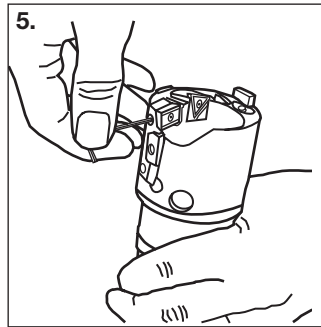
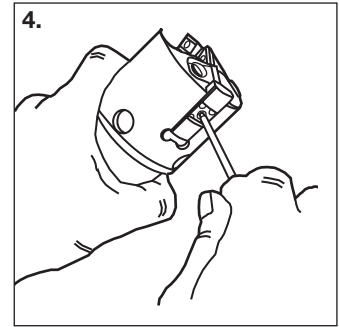
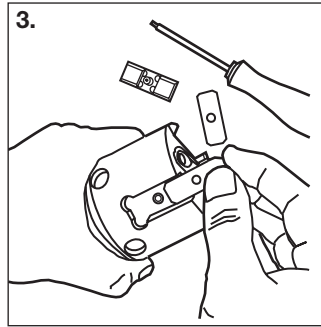
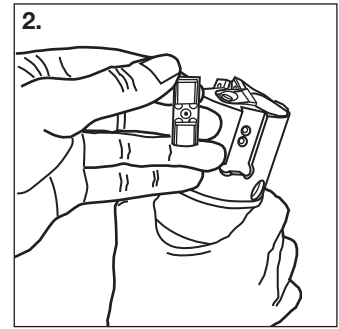
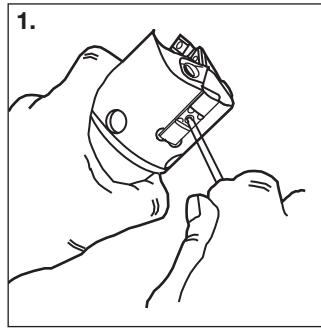



### Choice of carbide grades and insert geometries for ground brazed solid drill heads 424.6 and 420.6

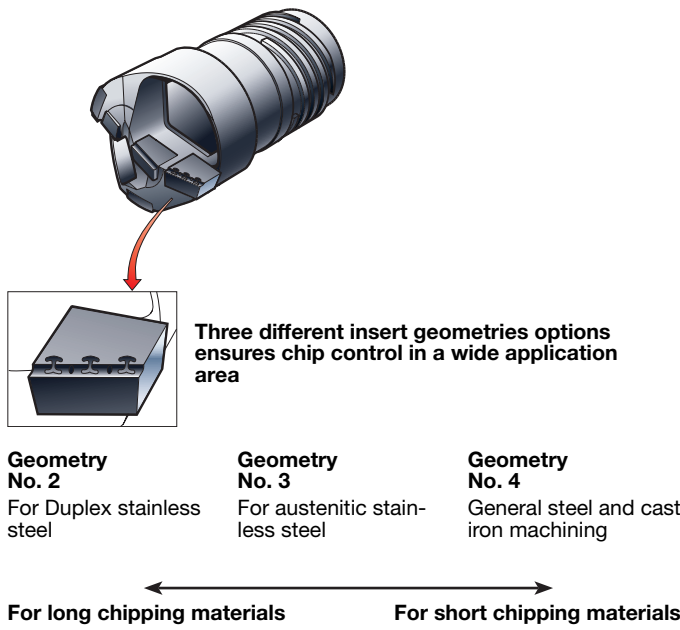

#### A wide range of carbide grade combinations

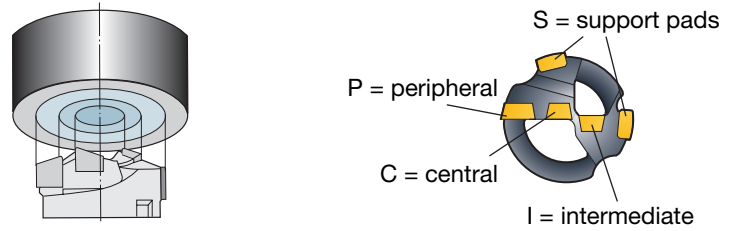

Insert	P		M		K		N		S	
	Chipbreaker									
		4	4	3/2	3	4		4		4
	Grade combination									
	70	63	20	67	72		72		72	
C = Central	P40	P40	M35	M35	K20		N20		S15	
I = Intermediate	P30	P30	M35	M35	K20		N20		S15	
P = Peripheral	P10	P30	M25	M35	K20		N20		S15	
S = Support pad	P20	P20	M20	M20	K20		N20		S15	

#### ISO P

Grade combination 70 is the first choice for machining unalloyed and alloyed steel. The right grade combination for high cutting speed. If better toughness behaviour is required choose grade combination 63.

#### ISO M

Grade combination 20 is the best choice for machining stainless steel. If better toughness behaviour is required choose grade combination 67.

#### ISO K

Grade combination 72 is the optimum choice for machining cast iron.

#### ISO N

Grade combination 72 is the best choice for machining aluminium alloys, copper and copper alloys.

#### ISO S

Grade combination 72 is the best choice for machining heat resistant super alloys and titanium.

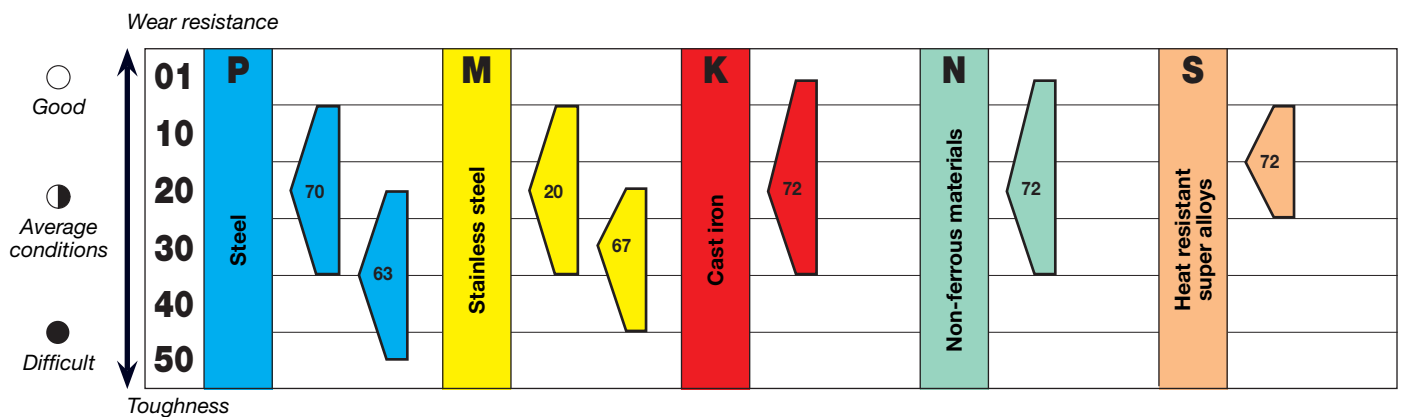

Optimized grade combinations for certain applications available on request.

#### SAFETY INFORMATION

Precautions when grinding and brazing of cemented carbide, see page 159.

## Insert geometries and grades for CoroDrill® 800.24 and 800.20 solid drill heads

### Insert geometries

#### Geometry (G)

- All round geometry
- High cutting feeds and speeds
- Good chip control in most materials

#### Geometry (L)

- Gives improved chip control in long chipping materials, such as low carbon steels and Duplex stainless steels
- Secure production process in materials where chip jamming easily could occur

### Support pad grades

#### New grade PM1

- Adds greater wear resistance in Duplex, stainless steels, titanium and heat resistant super alloys
- Complementary grade for steel
- New styling for easier identification and lower friction (black and yellow)

#### Grade P1

- First choice in steel applications

#### Grade M1

- First choice in ferritic and austenitic stainless and cast iron

### Grade recommendations per ISO application area

#### ISO P

**GC1025 (HC)** (P15–P50)  
A PVD coated universal grade with excellent wear resistance and toughness.

**P1 (HC)** (P15–P50)  
Coated support pad with excellent wear resistance.

**PM1 (HC)** (P10–P35)  
Support pad with new coating and substrate for tougher steels.

#### ISO M

**GC1025 (HC)** (M20–M40)  
A universal grade for ISO M application area. PVD coated with excellent toughness and resistance against built-up edge.

**M1 (HC)** (M20–M40)  
Coated support pad with excellent wear resistance.

**PM1 (HC)** (M15–M35)  
Support pad with new coating and substrate for stainless/Duplex steels.

#### ISO K

**GC1025 (HC)** (K10–K30)  
A universal grade for ISO K application area. Good combination of wear resistance and toughness.

**M1 (HC)** (K10–K30)  
Coated support pad with excellent wear resistance.

#### ISO N

**GC1025 (HC)** (N10–N30)  
Universal grade for aluminium alloys, copper and copper alloys.

**M1 (HC)** (N10–N30)  
Coated support pad with excellent wear resistance.

#### ISO S

**GC1025 (HC)** (S20–S40)  
A PVD coated grade with excellent wear resistance and toughness. Resistance against built-up edge.

**M1 (HC)** (S20–S40)  
Coated support pad with excellent wear resistance.

**PM1 (HC)** (S10–S40)  
Support pad with new coating and substrate for heat resistant super alloys and titanium.

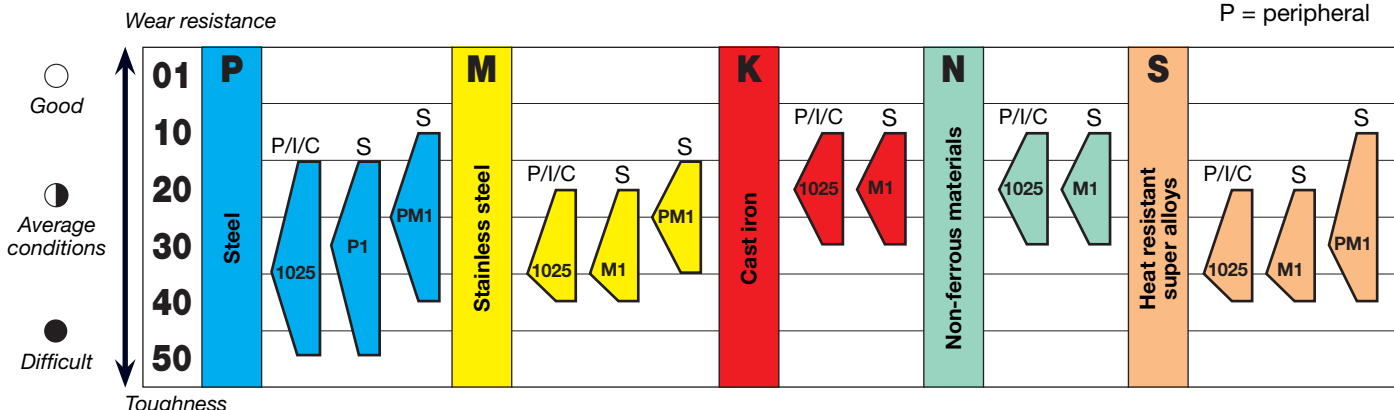
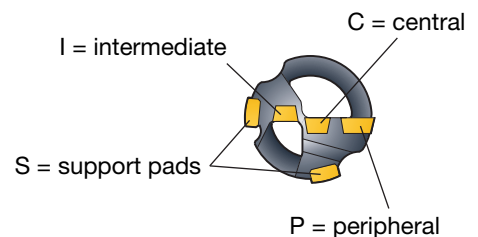

### Inserts for CoroDrill® 800.24 and 800.20 solid drill heads

Central

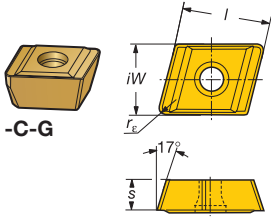

-C-G

Intermediate

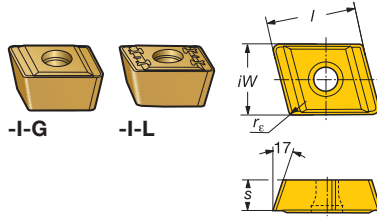

-I-G

-I-L

Peripheral

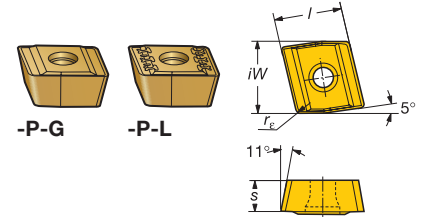

-P-G

-P-L

Insert size	Insert code	Coromant grades					GC = Coated carbide (ISO = HC)																																																																											
		P	M	K	N	S	Dimensions, mm																																																																											
		GC	GC	GC	GC	GC	<i>l</i>	<i>iW</i>	<i>s</i>	<i>r<sub>e</sub></i>																																																																								
		1025	1025	1025	1025	1025																																																																												
<div style="display: flex; justify-content: space-between;"> <div style="width: 15%;"> </div> <div style="width: 85%;"> <table border="1"> <thead> <tr> <th colspan="3">Central</th> </tr> </thead> <tbody> <tr><td>05</td><td>800-05 03 08M-C-G</td><td>★ ★ ★ ★ ★</td></tr> <tr><td>06</td><td>800-06 T3 08M-C-G</td><td>★ ★ ★ ★ ★</td></tr> <tr><td>08</td><td>800-08 T3 08M-C-G</td><td>★ ★ ★ ★ ★</td></tr> <tr><td>10</td><td>800-10 T3 08M-C-G</td><td>★ ★ ★ ★ ★</td></tr> <tr><td>12</td><td>800-12 T3 08M-C-G</td><td>★ ★ ★ ★ ★</td></tr> <tr> <th colspan="3">Intermediate</th> </tr> <tr><td>05</td><td>800-05 03 08M-I-G</td><td>★ ★ ★ ★ ★</td></tr> <tr><td>05</td><td>800-05 03 08M-I-L</td><td>★ ★ ★ ★ ★</td></tr> <tr><td>06</td><td>800-06 T3 08M-I-G</td><td>★ ★ ★ ★ ★</td></tr> <tr><td>06</td><td>800-06 T3 08M-I-L</td><td>★ ★ ★ ★ ★</td></tr> <tr><td>08</td><td>800-08 T3 08M-I-G</td><td>★ ★ ★ ★ ★</td></tr> <tr><td>08</td><td>800-08 T3 08M-I-L</td><td>★ ★ ★ ★ ★</td></tr> <tr><td>12</td><td>800-12 T3 08M-I-G</td><td>★ ★ ★ ★ ★</td></tr> <tr><td>12</td><td>800-12 T3 08M-I-L</td><td>★ ★ ★ ★ ★</td></tr> <tr> <th colspan="3">Peripheral</th> </tr> <tr><td>06</td><td>800-06 03 08H-P-G</td><td>★ ★ ★ ★ ★</td></tr> <tr><td>06</td><td>800-06 03 08H-P-L</td><td>★ ★ ★ ★ ★</td></tr> <tr><td>08</td><td>800-08 T3 08H-P-G</td><td>★ ★ ★ ★ ★</td></tr> <tr><td>08</td><td>800-08 T3 08H-P-L</td><td>★ ★ ★ ★ ★</td></tr> <tr><td>09</td><td>800-09 T3 08H-P-G</td><td>★ ★ ★ ★ ★</td></tr> <tr><td>09</td><td>800-09 T3 08H-P-L</td><td>★ ★ ★ ★ ★</td></tr> <tr><td>11</td><td>800-11 T3 08H-P-G</td><td>★ ★ ★ ★ ★</td></tr> <tr><td>11</td><td>800-11 T3 08H-P-L</td><td>★ ★ ★ ★ ★</td></tr> </tbody> </table> </div> </div>											Central			05	800-05 03 08M-C-G	★ ★ ★ ★ ★	06	800-06 T3 08M-C-G	★ ★ ★ ★ ★	08	800-08 T3 08M-C-G	★ ★ ★ ★ ★	10	800-10 T3 08M-C-G	★ ★ ★ ★ ★	12	800-12 T3 08M-C-G	★ ★ ★ ★ ★	Intermediate			05	800-05 03 08M-I-G	★ ★ ★ ★ ★	05	800-05 03 08M-I-L	★ ★ ★ ★ ★	06	800-06 T3 08M-I-G	★ ★ ★ ★ ★	06	800-06 T3 08M-I-L	★ ★ ★ ★ ★	08	800-08 T3 08M-I-G	★ ★ ★ ★ ★	08	800-08 T3 08M-I-L	★ ★ ★ ★ ★	12	800-12 T3 08M-I-G	★ ★ ★ ★ ★	12	800-12 T3 08M-I-L	★ ★ ★ ★ ★	Peripheral			06	800-06 03 08H-P-G	★ ★ ★ ★ ★	06	800-06 03 08H-P-L	★ ★ ★ ★ ★	08	800-08 T3 08H-P-G	★ ★ ★ ★ ★	08	800-08 T3 08H-P-L	★ ★ ★ ★ ★	09	800-09 T3 08H-P-G	★ ★ ★ ★ ★	09	800-09 T3 08H-P-L	★ ★ ★ ★ ★	11	800-11 T3 08H-P-G	★ ★ ★ ★ ★	11	800-11 T3 08H-P-L	★ ★ ★ ★ ★
Central																																																																																		
05	800-05 03 08M-C-G	★ ★ ★ ★ ★																																																																																
06	800-06 T3 08M-C-G	★ ★ ★ ★ ★																																																																																
08	800-08 T3 08M-C-G	★ ★ ★ ★ ★																																																																																
10	800-10 T3 08M-C-G	★ ★ ★ ★ ★																																																																																
12	800-12 T3 08M-C-G	★ ★ ★ ★ ★																																																																																
Intermediate																																																																																		
05	800-05 03 08M-I-G	★ ★ ★ ★ ★																																																																																
05	800-05 03 08M-I-L	★ ★ ★ ★ ★																																																																																
06	800-06 T3 08M-I-G	★ ★ ★ ★ ★																																																																																
06	800-06 T3 08M-I-L	★ ★ ★ ★ ★																																																																																
08	800-08 T3 08M-I-G	★ ★ ★ ★ ★																																																																																
08	800-08 T3 08M-I-L	★ ★ ★ ★ ★																																																																																
12	800-12 T3 08M-I-G	★ ★ ★ ★ ★																																																																																
12	800-12 T3 08M-I-L	★ ★ ★ ★ ★																																																																																
Peripheral																																																																																		
06	800-06 03 08H-P-G	★ ★ ★ ★ ★																																																																																
06	800-06 03 08H-P-L	★ ★ ★ ★ ★																																																																																
08	800-08 T3 08H-P-G	★ ★ ★ ★ ★																																																																																
08	800-08 T3 08H-P-L	★ ★ ★ ★ ★																																																																																
09	800-09 T3 08H-P-G	★ ★ ★ ★ ★																																																																																
09	800-09 T3 08H-P-L	★ ★ ★ ★ ★																																																																																
11	800-11 T3 08H-P-G	★ ★ ★ ★ ★																																																																																
11	800-11 T3 08H-P-L	★ ★ ★ ★ ★																																																																																

Ordering example: 10 pieces 800-05 03 08M-C-G 1025

### Support pads for CoroDrill® 800 solid drill heads

Support pad PM1

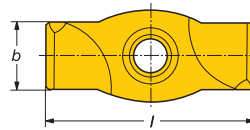

Support pad P1 and M1



Support pad width, <i>b</i>	Support pad code	Coromant grades					GC = Coated carbide (ISO = HC)			
		P	M	K	N	S	Dimensions, mm			
		GC	GC	GC	GC	GC	<i>b</i>	<i>l</i>	<i>s</i>	
		P1	PM1	M1	PM1	M1	M1	M1	PM1	
06	800-06A	★ ☆	★ ☆	★	★	★	★	★	★	
07	800-07A	★ ☆	★ ☆	★	★	★	★	★	★	
08	800-08A	★ ☆	★ ☆	★	★	★	★	★	★	
10	800-10A	★ ☆	★ ☆	★	★	★	★	★	★	
12	800-12A	★ ☆	★ ☆	★	★	★	★	★	★	

★ = First choice

Ordering example: 10 pieces 800-06A P1

## Insert geometries and grades for T-MAX® 424.10 solid drill heads

### Insert geometries

#### Geometry -22

- All round geometry
- High cutting feeds and speeds
- Good chip control in most materials including: steel, cast iron, aluminium and other non-ferrous metals

#### Geometry -23

- First choice for long chipping materials such as: stainless steels, heat resistant super alloys
- Good chip control at moderate feeds and speeds

### Grade recommendations per ISO application area

#### ISO P

**GC1025 (HC)** (P15-P50)  
First choice for ISO P materials.  
A PVD coated universal grade with excellent wear resistance and toughness.

**CG 235 (HC)** (P25-P50)  
Combines good wear resistance at low to moderate cutting speeds with excellent toughness behaviour.

#### ISO M

**GC1025 (HC)** (M20-M40)  
First choice for ISO M materials.  
PVD coated grade with excellent edge toughness and resistance against built-up edge.

**GC235 (HC)** (M20-M40)  
Good edge toughness and resistance against built-up. First choice for austenitic stainless steel.

#### ISO K

**H13A (HW)** (K10-K30)  
Grade for low to moderate cutting speeds. Ideal choice for machining ferritic modular cast iron.

#### ISO N

**H13A (HW)** (N10-N30)  
Grade for low to moderate cutting speeds in aluminium alloys, copper and copper alloys.

#### ISO S

**GC1025 (HC)** (S05-S30)  
A PVD coated grade with excellent wear resistance and toughness at moderate cutting speeds.

**H13A (HW)** (S10-S30)  
The first choice for machining heat resistant super alloys and titanium. Good edge sharpness, wear resistance and toughness.

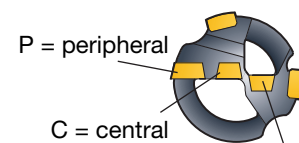

I = intermediate

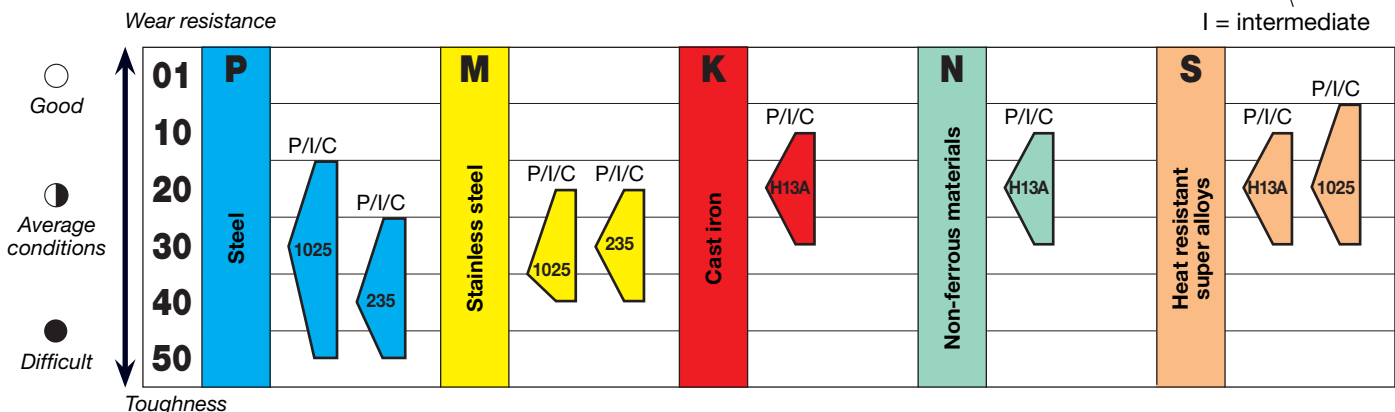

### Inserts for T-MAX<sup>®</sup> 424.10 solid drill heads

Central and intermediate

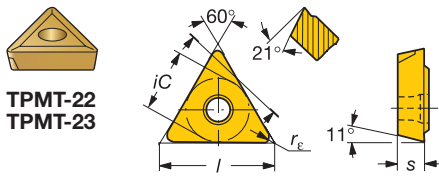

TPMT-22  
TPMT-23

Peripheral

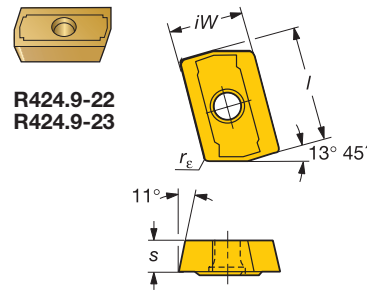

R424.9-22  
R424.9-23

Insert size	Insert code	Coromant grades										Dimensions, mm				
		P		M		K		N		S		iC	iW	l	s	r <sub>ε</sub>
		GC	GC	GC	GC	-	-	-	-	GC	-					
		1025	235	1025	235	H13A		H13A		1025	H13A					
		GC = Coated carbide ISO = HC - = Uncoated cemented carbide (ISO = HW)														
		Central and intermediate														
16	TPMT 16 T3 12R-22 16 T3 12TR-23	★	☆	★	☆					★		9,525	-	16,5	3,97	1,2
		★	☆	★	☆	★		★		☆	★	9,525	-	16,5	3,97	1,2
22	TPMT 22 06 12R-22 22 06 12TR-23	★	☆	★	☆					★		12,7	-	22,0	6,35	1,2
		★	☆	★	☆	★		★		☆	★	12,7	-	22,0	6,35	1,2
		Peripheral														
13	R424.9- 13 T3 08-22 13 T3 08-23	★	☆	★	☆					★		-	10,0	14,7	3,97	0,8
		★	☆	★	☆	★		★		☆	★	-	10,0	14,7	3,97	0,8
18	R424.9- 18 06 08-22 18 06 08-23	★	☆	★	☆					★		-	11,5	20,6	6,35	0,8
		★	☆	★	☆	★		★		☆	★	-	11,5	20,6	6,35	0,8

★ = First choice

Ordering example: 10 pieces TPMT 16 T3 12R-22 1025

### Support pads for T-MAX<sup>®</sup> 424.10 solid drill heads

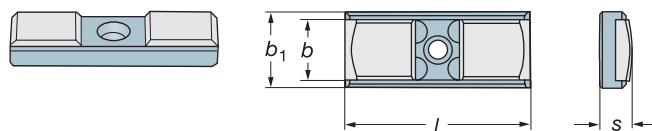

Support pad width, b	Support pad code	Coromant grades					Dimensions, mm				
		P	M	K	N	S	b	b <sub>1</sub>	l	s	
		-	-	-	-	-					
		S2	S2	S2	S2	S2					
		- = Uncoated cemented carbide (ISO = HW)									
12	430.32-12 Dxx.x	★	★	★	★	★	12	14	35	7,0	
16	430.32-16 Dxx.x	★	★	★	★	★	16	20	50	8,5	

★ = First choice

Ordering example: 10 pieces 430.32-12 D65,0

Se pages 22 and 58

## Insert geometries and grades for T-MAX® 424.31F/424.31 counterboring solid drill heads

### Insert geometries

#### 424.31F: hole diameter range 20,00–43,00 mm

Finishing geometry for hole tolerance IT9

- Good chip control and excellent surface finish in most materials including: steel, stainless steels, heat resistant super alloys, aluminium and other non-ferrous materials
- High cutting feeds and speeds

#### 424.31F: hole diameter range 43,01–124,00 mm

Finishing to light roughing geometry for hole tolerance IT9

- Good chip control and excellent surface finish in most materials including: steel, stainless steels, heat resistant super alloys, aluminium and other non-ferrous materials
- High cutting feeds and speeds

#### 424.31F/424.31: hole diameter range 43,01–124,00 mm

Semi-finishing and roughing geometries for hole tolerance IT10

**SNMG** (double sided)

- All round geometry for machining at medium feeds
- Suitable for short chipping materials

**SNMM** (single sided)

- For roughing and semi-finishing
- Strong straight cutting edge

**SNMG-15** (double sided)

- Wide chipbreaking area
- Positive cutting action

**TPMX** (single sided)

- Parallel land for better surface finish
- Low cutting forces

**TPUN** (single sided)

- With loose chipbreaker
- Alternative for TPMX inserts if chipbreaking problems occur

### Grade recommendations per ISO application area

#### ISO P

**GC235 (HC)** (P25-P50)

Combines good wear resistance at low to moderate cutting speeds with excellent toughness behaviour.

**GC4235 (HC)** (P20-P45)

Good toughness and wear resistance. Relatively high cutting speeds.

**S6 (HW)** (P35-P45)

Good toughness. Low cutting speeds. For difficult machining conditions.

#### ISO M

**GC235 (HC)** (M20-M40)

The first choice for austenitic stainless steel. Good edge toughness and resistance against built-up edge.

**S6 (HW)** (M30-M40)

Suitable for difficult machining conditions. Good edge toughness.

#### ISO K

**GC4235 (HC)** (K05-K25)

Good edge toughness in combination with wear resistance at moderate to high cutting speeds.

#### ISO N

**GC4235 (HC)** (N05-N25)

Good edge toughness in combination with wear resistance at moderate to high cutting speeds.

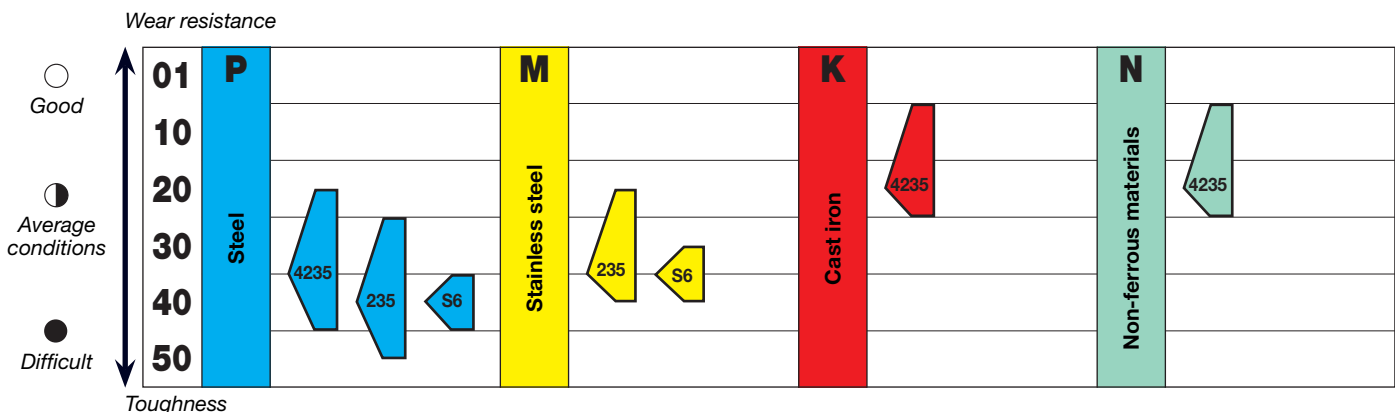

### Insert for T-MAX<sup>®</sup> 424.31F/424.31 counterboring solid drill heads

**424.31F – close tolerance (IT9)**

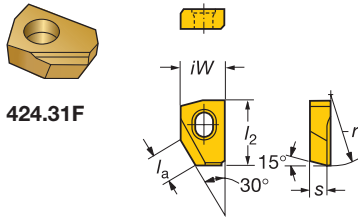

Hole diameter 20,00–43,00 mm  
Max. cutting depth  $a_p$  3,0 mm

**424.31F – close tolerance (IT9)**

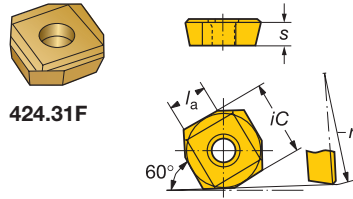

Hole diameter 43,01–124,00 mm  
Max. cutting depth  $a_p$  4,5 mm

**424.31F/424.31 – normal tolerance (IT10)**

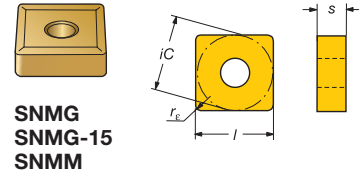

**SNMG  
SNMG-15  
SNMM**

Hole diameter 43,01–124,00 mm  
Max. cutting depth  $a_p$   
6,0 mm ( $l = 09$  mm)  
10,0 mm ( $l = 12$  mm)  
16,0 mm ( $l = 19$  mm)

**424.31 – normal tolerance (IT10)**

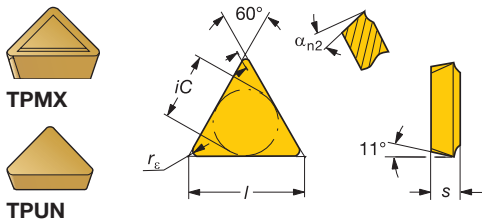

Hole diameter 43,01–124,00 mm  
Max. cutting depth  $a_p$   
12,0 mm ( $l = 16$  mm)  
17,0 mm ( $l = 22$  mm)

Insert size	Insert code	Coromant grades								Dimensions, mm									
		P		M		K		N		l	l <sub>2</sub>	iC	iW	s	l <sub>a</sub>	r	r <sub>e</sub>	α <sub>n2</sub>	
		GC	GC	-	GC	-	GC	GC	GC										
		235	4235	S6	235	S6	4235	4235	4235										
	For 424.31F																		
04	R424.31F-04 03 00	★			★														
06	R424.31F-06 T3 00	★			★														
09	SNMG 09 03 08		★	☆		☆	★	★		★									
	09 03 08-15 PM		★				★	★		★									
	SNMM 09 03 08		★				★	★		★									
12	For 424.31																		
	SNMG 12 04 12 PM		★				★	★		★									
	12 04 12-15 PM		★				★	★		★									
	SNMM 12 04 12 PR		★				★	★		★									
19	SNMG 19 06 12 PR		★				★	★		★									
	19 06 12-15 PM		★				★	★		★									
	SNMM 19 06 12 PR		★				★	★		★									
16	TPMX 16 03 12 R22	★		☆	☆	☆	★											20°	
22	TPMX 22 04 12 R22	★		☆	☆	☆	★												17°
16	TPUN 16 03 12	★		☆	☆	☆	★	★		★									
22	TPUN 22 04 12	★		☆	☆	☆	★	★		★									

★ = First choice

Ordering example: 10 pieces R424.31F-04 03 00 GC235



## Cutting data for ground brazed solid drill heads 424.6 and 420.6

ISO	CMC No.	Material		Specific cutting force $k_c$ 0,4 N/mm <sup>2</sup>	Hardness Brinell HB	Grade combination	Cutting speed $v_c$ m/min	Drill diameter, mm				
								15,60-20,00	20,01-31,00	31,01-43,00	43,01-65,00	
								Feed, $f_n$ mm/r				
P	01.1	Unalloyed	Non-hardened 0,1-0,25% C	2000	90-200	70/63	70-120	0,14-0,20 <sup>1)</sup>	0,15-0,20 <sup>1)</sup>	0,15-0,25	0,18-0,28	
	01.2		Non-hardened 0,25-0,55% C	2100	125-225	70/63	70-120	0,14-0,20 <sup>1)</sup>	0,15-0,20 <sup>1)</sup>	0,15-0,25	0,18-0,28	
	01.3		Non-hardened 0,55-0,80% C	2180	150-250	70/63	70-120	0,14-0,20	0,17-0,25	0,20-0,30	0,24-0,32	
	01.4		High carbon steel, annealed	2320	180-275	70/63	70-120	0,14-0,20	0,17-0,25	0,20-0,30	0,24-0,32	
	Steel	02.1	Low alloy	Non-hardened	2100	150-260	70/63	70-100	0,14-0,20	0,17-0,25	0,20-0,30	0,24-0,32
		02.2		Hardened and tempered	2775	220-450	70/63	55-100	0,14-0,20	0,17-0,25	0,20-0,30	0,24-0,32
		03.11	High alloy	Annealed	2500	150-250	70/63	70-100	0,14-0,20	0,17-0,25	0,20-0,30	0,24-0,32
				Annealed HSS	2750	150-250	70/63	70-100	0,14-0,20	0,17-0,25	0,20-0,30	0,24-0,32
				Hardened tool steels	3750	250-350	70/63	55-100	0,14-0,20	0,17-0,25	0,20-0,30	0,24-0,32
				Hardened steels, others	4000	250-450	70/63	55-100	0,14-0,20	0,17-0,25	0,20-0,30	0,24-0,32
06.1		Castings	Unalloyed	1800	90-225	70/63	50-100	0,12-0,18	0,15-0,22	0,20-0,28	0,24-0,32	
			Low alloyed (alloying elements <5%)	2100	150-250	70/63	50-100	0,12-0,18	0,15-0,22	0,20-0,28	0,24-0,32	
06.32		Castings	Stainless austenitic	2300	150-250	20 <sup>2)</sup> /67	50-85	0,16-0,20	0,18-0,25	0,22-0,30	0,24-0,36	
			Manganese steel 12-14% Mn	3600	200-300	20 <sup>2)</sup> /67	35-70	0,16-0,20	0,18-0,25	0,22-0,30	0,24-0,36	
M	Stainless steel	05.11	Rolled/forged	Ferritic, martensitic	2300	150-270	20 <sup>2)</sup> /67	40-85	0,16-0,20	0,18-0,25	0,22-0,30	0,24-0,36
				Non-hardened								
		05.21	Rolled/forged	Austenitic	2600	150-275	20 <sup>2)</sup> /67	40-85	0,16-0,20	0,18-0,25	0,22-0,30	0,24-0,36
05.51	Rolled/forged	Austenitic/ferritic (Duplex) non-weldable $\geq 0,05\%$ C	2600	180-290	20 <sup>2)</sup> /67	35-60	0,12-0,15	0,20-0,27	0,22-0,30	0,25-0,35		
		Austenitic/ferritic (Duplex) Weldable <0,05% C	3000	200-320	20 <sup>2)</sup> /67	35-60	0,12-0,15	0,20-0,27	0,22-0,30	0,25-0,35		
K	Cast iron	07.1	Malleable	Ferritic	950	110-145	72	80-100	0,14-0,20	0,18-0,25	0,20-0,30	0,24-0,32
				Pearlitic	1100	150-270	72	80-100	0,14-0,20	0,18-0,25	0,20-0,30	0,24-0,32
		08.1	Grey	Low tensile strength	1100	150-220	72	60-100	0,12-0,18	0,15-0,22	0,20-0,28	0,24-0,32
				High tensile strength	1290	200-330	72	60-100	0,12-0,18	0,15-0,22	0,20-0,28	0,24-0,32
		09.1	Nodular	Ferritic	1050	125-230	72	50-100	0,12-0,18	0,15-0,22	0,20-0,28	0,24-0,32
				Pearlitic	1750	200-300	72	50-100	0,12-0,18	0,15-0,22	0,20-0,28	0,24-0,32
N	Non-ferrous metals	30.11	Aluminium alloys	Wrought or wrought and coldworked, non aging	500	30-100	72	65-130	0,10-0,20	0,16-0,25	0,18-0,30	0,20-0,45
				non aging	800	30-150	72	65-130	0,10-0,20	0,16-0,25	0,18-0,30	0,20-0,45
		30.21	Aluminium alloys	Cast, non again	750	40-100	72	65-130	0,10-0,20	0,16-0,25	0,18-0,30	0,20-0,45
				Cast or cast and aged	900	70-140	72	65-130	0,10-0,20	0,16-0,25	0,18-0,30	0,20-0,45
		33.1	Copper and copper alloys	Free cutting alloys Pb >1%	700	70-160	72	65-130	0,10-0,20	0,16-0,25	0,18-0,30	0,20-0,45
				Brass and leaded bronzes Pb $\leq 1\%$	700	50-200	72	65-130	0,10-0,20	0,16-0,25	0,18-0,30	0,20-0,45
S	Heat resistans super alloys	20.11	Iron base	Annealed or solution treated	3000	180-230	72	10-50	0,10-0,18	0,14-0,20	0,18-0,26	0,20-0,30
				Annealed or solution treated	3320	140-300	72	10-50	0,10-0,18	0,14-0,20	0,18-0,26	0,20-0,30
				Annealed or solution treated	3300	180-230	72	10-50	0,10-0,18	0,14-0,20	0,18-0,26	0,20-0,30
		23.21	Titanium	Alfa, near alfa and alfa + beta alloys annealed	1675	Rm <sup>3)</sup> 600-1100	72	30-50	0,14-0,16	0,16-0,22	0,18-0,26	0,20-0,30

1) Ejector drills in small diameters, not recommended for CMC 01.1 with carbon  $\leq 0,18\%$ .  
STS drills are the recommended alternative.

Graphs see page 87.

2) Only for STS drills.

3) Rm = ultimate tensile strength measured in MPa.

For carbide grades and grade combination, see page 79.

## Graphs for Ejector and STS drill head 424.6 and 420.6

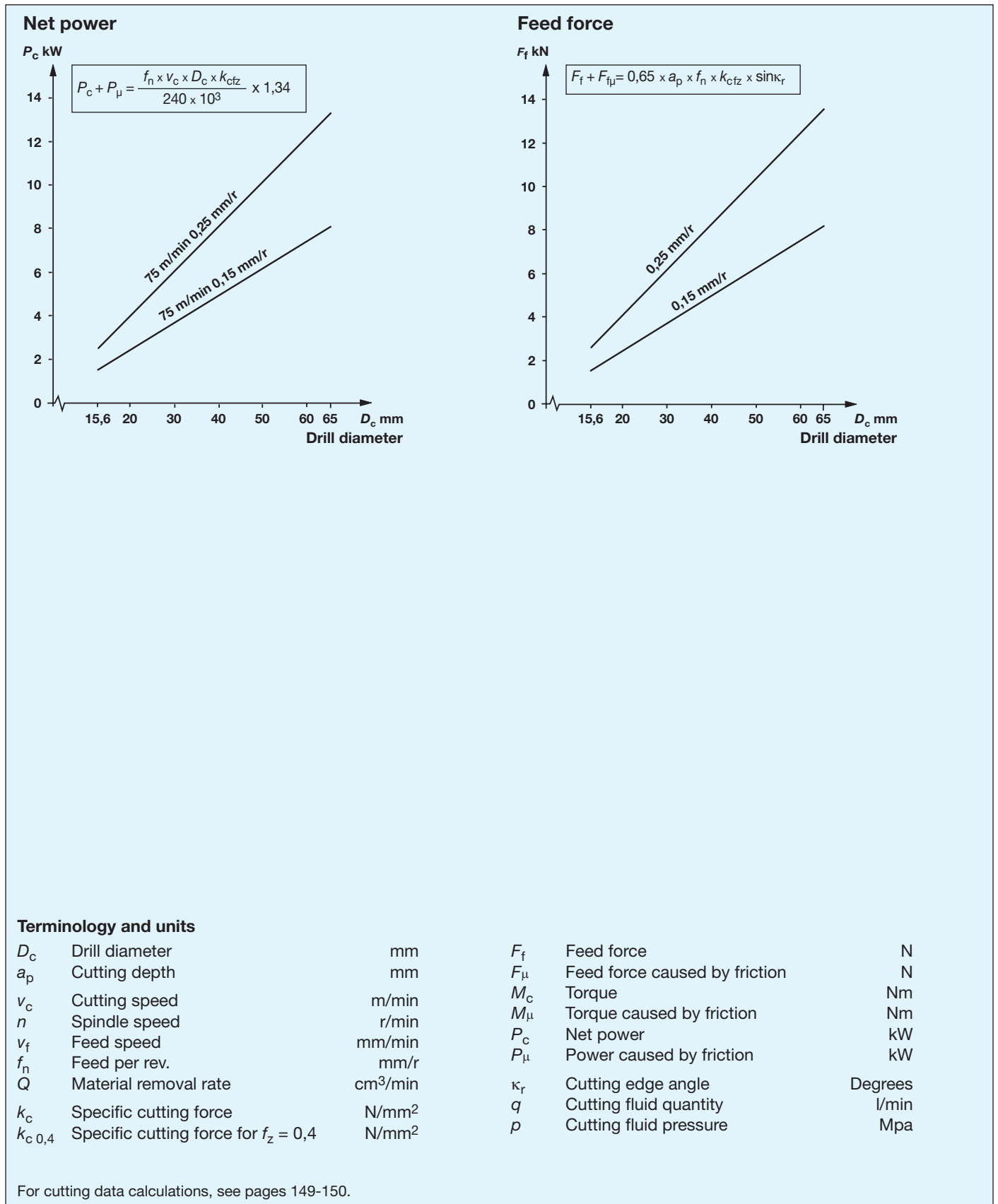

The graphs show nominal values which should not be regarded as strict recommendations. The values may need adjusting depending on the machining conditions e.g., the type of material.

Note that only net power ratings are given. Allowance must be made for the efficiency of the machine and the cutting edge wear.

Graphs for Ejector and STS drill head 424.6 and 420.6

**Ejector – 424.6**

**Cutting fluid flow**

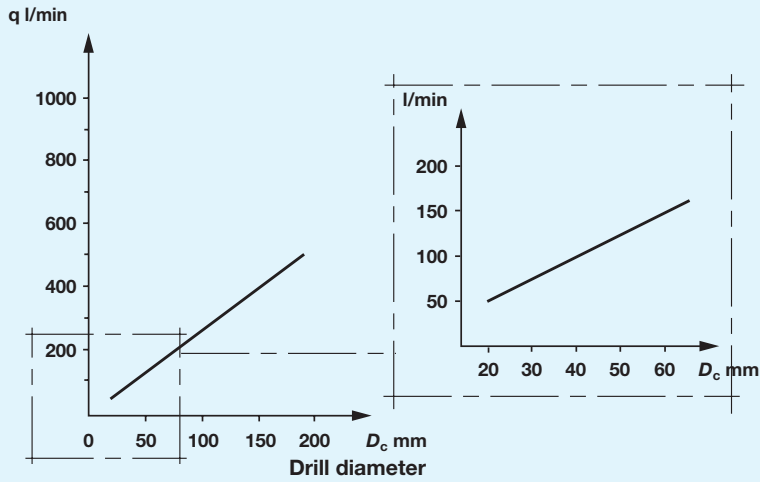

**Cutting fluid pressure**

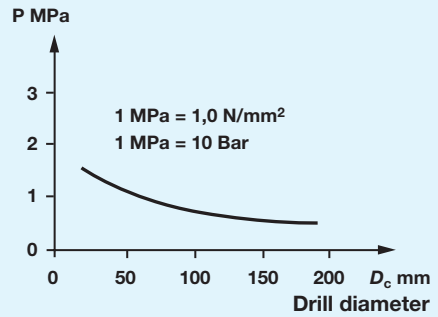

For optimal tool life, use at least 10% mixture when emulsion is used.

**STS – 420.6**

**Cutting fluid flow**

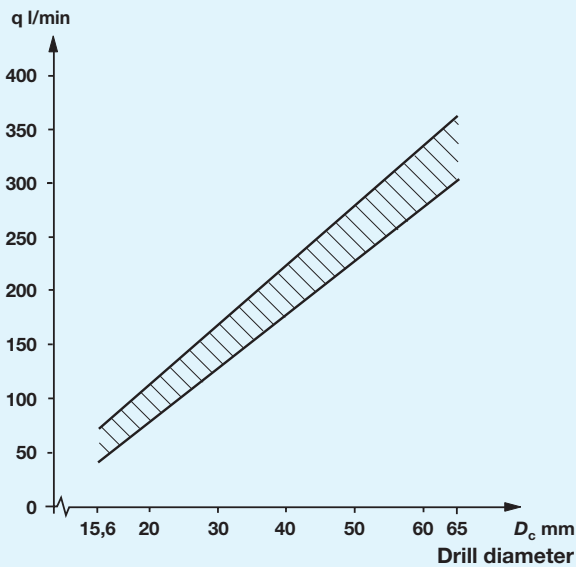

**Cutting fluid pressure**

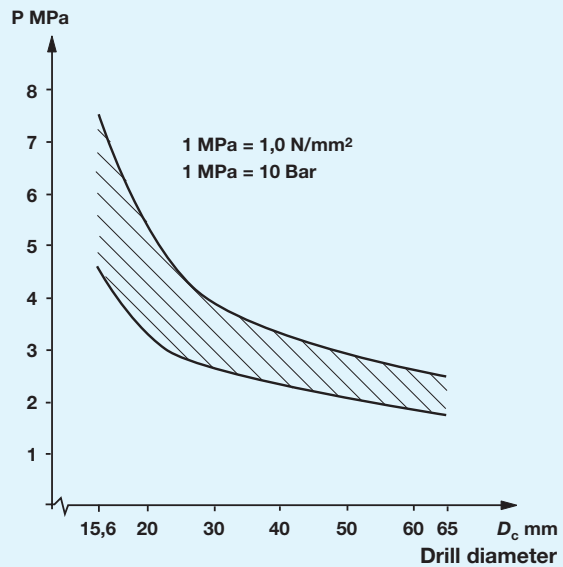

For cutting data calculations, see pages 149-150.

The graphs show nominal values which should not be regarded as strict recommendations. The values may need adjusting depending on the machining conditions e.g., the type of material.

Note that only net power ratings are given. Allowance must be made for the efficiency of the machine and the cutting edge wear.

## Cutting data for CoroDrill® solid drill heads 800.24 and 800.20

ISO	CMC No.	Material		Specific cutting force $k_c$ 0,4 N/mm <sup>2</sup>	Hardness Brinell HB	Geometry/grade			Support pad grade	Cutting speed $v_c$ m/min	Feed, $f_n$ mm/r	
						Insert*)					Drill diameter, mm	
						P	I	C			25,00-43,00	43,01-65,00
Steel	01.1	Unalloyed	Non-hardened 0,1-0,25% C Non-hardened 0,25-0,55% C Non-hardened 0,55-0,80% C High carbon steel, annealed	2000	90-200	G/1025	G/1025	G/1025	P1	70-130	0,11-0,41	0,14-0,45
	01.2			2100	125-225	G/1025	G/1025	G/1025	P1	70-130	0,11-0,41	0,14-0,45
	01.3			2180	150-250	G/1025	G/1025	G/1025	P1	70-130	0,11-0,41	0,14-0,45
	01.4			2320	180-275	G/1025	G/1025	G/1025	P1	70-130	0,11-0,41	0,14-0,45
	02.1	Low alloy	Non-hardened Hardened and tempered	2100	150-260	G/1025	G/1025	G/1025	P1	70-120	0,11-0,41	0,20-0,45
	02.2			2775	220-450	G/1025	G/1025	G/1025	P1	55-110	0,11-0,41	0,20-0,45
	03.11	High alloy	Annealed Annealed HSS Hardened tool steels Hardened steels, others	2500	150-250	G/1025	G/1025	G/1025	P1	70-120	0,11-0,41	0,20-0,45
	03.13			2750	150-250	G/1025	G/1025	G/1025	P1	70-120	0,11-0,41	0,20-0,45
	03.21			3750	250-350	G/1025	G/1025	G/1025	P1	55-110	0,11-0,38	0,20-0,40
	03.22			4000	250-450	G/1025	G/1025	G/1025	P1	55-110	0,20-0,38	0,20-0,40
06.1	Castings	Unalloyed Low alloyed (alloying elements <5%)	1800	90-225	G/1025	G/1025	G/1025	P1	55-110	0,11-0,41	0,20-0,45	
06.2			2100	150-250	G/1025	G/1025	G/1025	P1	55-110	0,11-0,41	0,20-0,45	
06.32	Castings	Stainless austenitic Manganese steel 12-14% Mn	2300	150-250	G/1025	G/1025	G/1025	P1	50-100	0,11-0,33	0,20-0,38	
06.33			3600	200-300	G/1025	G/1025	G/1025	P1	35- 85	0,11-0,33	0,20-0,38	
Stainless steel	05.11	Rolled/forged	Ferritic, martensitic Non-hardened	2300	150-270	G/1025	G/1025	G/1025	M1	40-110	0,11-0,41	0,20-0,45
	05.21	Rolled/forged	Austenitic	2600	150-275	G/1025	G/1025	G/1025	M1	40-110	0,11-0,41	0,20-0,45
	05.51	Rolled/forged	Austenitic/ferritic (Duplex) non-weldable $\geq 0,05\%$ C	2600	180-290	G/1025	G/1025	G/1025	M1	40-110	0,11-0,33	0,20-0,35
	05.52	Rolled/forged	Austenitic/ferritic (Duplex) Weldable <0,05% C	3000	200-320	G/1025	G/1025	G/1025	M1	40- 80	0,11-0,33	0,20-0,35
Cast iron	07.1	Malleable	Ferritic Pearlitic	950	110-145	G/1025	G/1025	G/1025	M1	80-120	0,11-0,38	0,24-0,41
	07.2			1100	150-270	G/1025	G/1025	G/1025	M1	80-120	0,11-0,38	0,24-0,41
	08.1	Grey	Low tensile strength High tensile strength	1100	150-220	G/1025	G/1025	G/1025	M1	60-110	0,11-0,38	0,24-0,41
	08.2			1290	200-330	G/1025	G/1025	G/1025	M1	60-110	0,11-0,38	0,24-0,41
09.1	Nodular	Ferritic Pearlitic	1050	125-230	G/1025	G/1025	G/1025	M1	50-110	0,11-0,38	0,24-0,41	
09.2			1750	200-300	G/1025	G/1025	G/1025	M1	50-110	0,11-0,38	0,24-0,41	
Non-ferrous metals	30.11	Aluminium alloys	Wrought or wrought and coldworked, non aging	500	30-100	G/1025	G/1025	G/1025	M1	65-150	0,09-0,33	0,24-0,35
	30.12			800	30-150	G/1025	G/1025	G/1025	M1	65-150	0,09-0,33	0,24-0,35
	30.21	Aluminium alloys	Cast, non aging Cast or cast and aged	750	40-100	G/1025	G/1025	G/1025	M1	65-150	0,09-0,33	0,24-0,35
	30.22			900	70-140	G/1025	G/1025	G/1025	M1	65-150	0,09-0,33	0,24-0,35
	33.1	Copper and copper alloys	Free cutting alloys Pb >1% Brass and leaded bronzes Pb $\leq 1\%$	700	70-160	G/1025	G/1025	G/1025	M1	65-150	0,09-0,33	0,24-0,35
	33.2			700	50-200	G/1025	G/1025	G/1025	M1	65-150	0,09-0,33	0,24-0,35
Heat resistants super alloys	20.11	Iron base	Annealed or solution treated	3000	180-230	G/1025	G/1025	G/1025	PM1	10- 55	0,09-0,30	0,20-0,33
	20.21	Nickel base	Annealed or solution treated	3320	140-300	G/1025	G/1025	G/1025	PM1	10- 55	0,09-0,30	0,20-0,33
	20.31	Cobalt base	Annealed or solution treated	3300	180-230	G/1025	G/1025	G/1025	PM1	10- 55	0,09-0,30	0,20-0,33
	23.21	Titanium	Alfa, near alfa and alfa + beta alloys annealed	1675	Rm <sup>2)</sup> 600-1100	G/1025	G/1025	G/1025	PM1	30- 60	0,09-0,30	0,20-0,33

\*) Insert position – P, I, C

P= Peripheral, I= Intermediate, C= Central

2) Rm = ultimate tensile strength measured in MPa

A straight oil improves the tool life compared to mixed emulsion.

Graphs see page 90-91.

Graphs for Ejector and STS drills 800.24 and 800.20

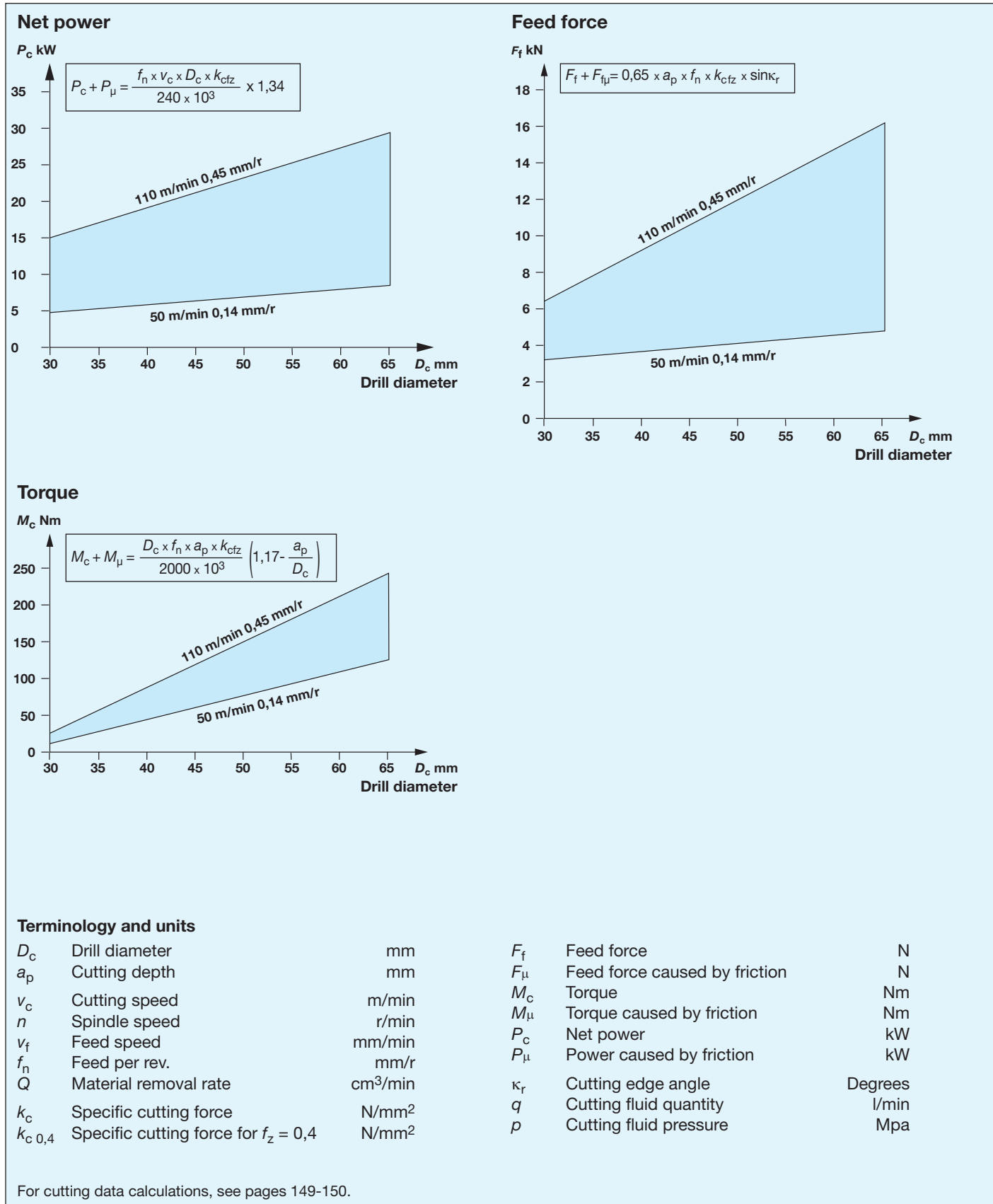

The graphs show nominal values which should not be regarded as strict recommendations. The values may need adjusting depending on the machining conditions e.g., the type of material.

Note that only net power ratings are given. Allowance must be made for the efficiency of the machine and the cutting edge wear.

### Graphs for Ejector and STS drills 800.24 and 800.20

#### Ejector – 800.24

##### Cutting fluid flow

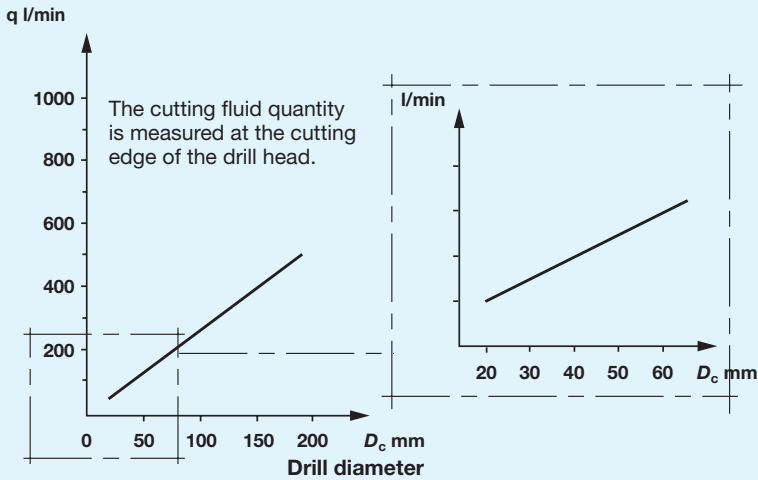

##### Cutting fluid pressure

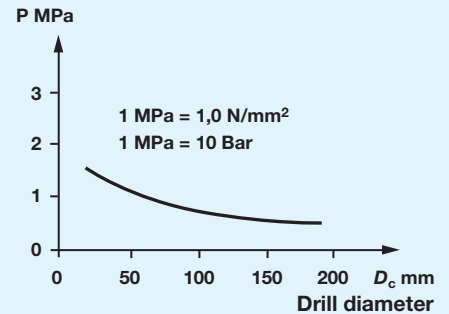

For optimal tool life, use at least 10% mixture when emulsion is used.

#### STS – 800.20

##### Cutting fluid flow

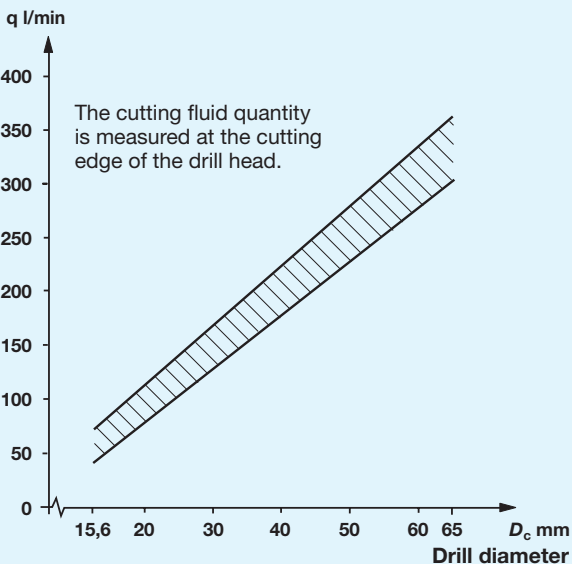

##### Cutting fluid pressure

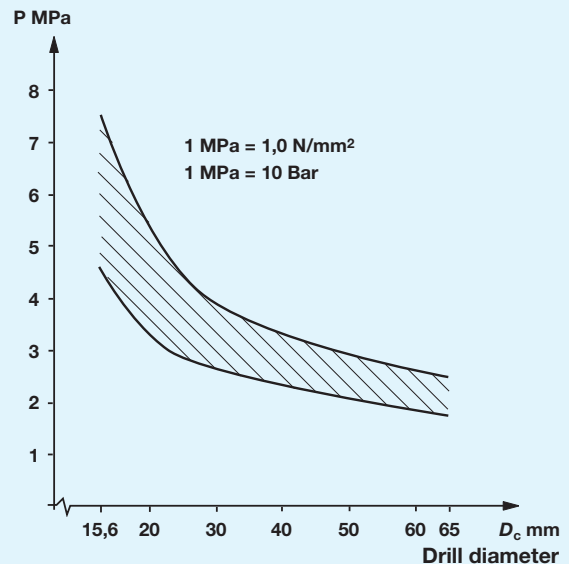

#### Terminology and units

$D_c$	Drill diameter	mm	$F_f$	Feed force	N
$a_p$	Cutting depth	mm	$F_\mu$	Feed force caused by friction	N
$v_c$	Cutting speed	m/min	$M_c$	Torque	Nm
$n$	Spindle speed	r/min	$M_\mu$	Torque caused by friction	Nm
$v_f$	Feed speed	mm/min	$P_c$	Net power	kW
$f_n$	Feed per rev.	mm/r	$P_\mu$	Power caused by friction	kW
$Q$	Material removal rate	cm <sup>3</sup> /min	$\kappa_r$	Cutting edge angle	Degrees
$k_c$	Specific cutting force	N/mm <sup>2</sup>	$q$	Cutting fluid quantity	l/min
$k_{c0,4}$	Specific cutting force for $f_z = 0,4$	N/mm <sup>2</sup>	$p$	Cutting fluid pressure	Mpa

For cutting data calculations, see pages 149-150.

The graphs show nominal values which should not be regarded as strict recommendations. The values may need adjusting depending on the machining conditions e.g., the type of material.

Note that only net power ratings are given. Allowance must be made for the efficiency of the machine and the cutting edge wear.

Cutting data for T-MAX<sup>®</sup> adjustable solid drill head 424.10

ISO	CMC No.	Material		Specific cutting force $k_c$ 0,4	Hardness Brinell	Geometry/grade	Cutting speed	Drill diameter, mm	
								≥ 63,50	
								Feed, $f_n$ mm/r	
				N/mm <sup>2</sup>	HB		$v_c$ m/min		
P	01.1	Unalloyed	Non-hardened 0,1-0,25% C		2000	90-200	-22/-23/1025	80-100	0,18-0,35
	01.2		Non-hardened 0,25-0,55% C		2100	125-225	-22/1025	80-100	0,18-0,35
	01.3		Non-hardened 0,55-0,80% C		2180	150-250	-22/1025	80-100	0,18-0,35
	01.4		High carbon steel, annealed		2320	180-275	-22/1025	80-100	0,18-0,35
	02.1	Low alloy	Non-hardened		2100	150-260	-22/1025	70-100	0,18-0,35
	02.2		Hardened and tempered		2775	220-450	-22/1025	60-100	0,16-0,35
	03.11	High alloy	Annealed		2500	150-250	-22/1025	70-100	0,18-0,30
	03.13		Annealed HSS		2750	150-250	-22/1025	70-100	0,18-0,30
	03.21		Hardened tool steels		3750	250-350	-22/1025	60-100	0,16-0,30
	03.22		Hardened steels, others		4000	250-450	-22/1025	60-100	0,16-0,30
06.1	Castings	Unalloyed		1800	90-225	-22/1025	50-100	0,15-0,30	
06.2		Low alloyed (alloying elements <5%)		2100	150-250	-22/1025	50-100	0,15-0,30	
M	05.11	Rolled/forged	Ferritic, martensitic Non-hardened		2300	150-270	-22/1025	50- 90	0,16-0,35
	05.21	Rolled/forged	Austenitic		2600	150-275	-23/1025	50- 90	0,16-0,35
K	07.1	Malleable	Ferritic		950	110-145	-22/H13A	80-100	0,18-0,30
	07.2		Pearlitic		1100	150-270	-22/H13A	80-100	0,18-0,30
	08.1	Grey	Low tensile strength		1100	150-220	-22/H13A	60-100	0,16-0,35
	08.2		High tensile strength		1290	200-330	-22/H13A	60-100	0,16-0,35
	09.1	Nodular	Ferritic		1050	125-230	-22/H13A	50-100	0,16-0,35
	09.2		Pearlitic		1750	200-300	-22/H13A	50-100	0,16-0,35
N	30.11	Aluminium alloys	Wrought or wrought and coldworked, non aging		500	30-100	-23/H13A	65-130	0,10-0,30
	30.12		Wrought or wrought and aged		800	30-150	-23/H13A	65-130	0,10-0,30
	30.21	Aluminium alloys	Cast, non again		750	40-100	-23/H13A	65-130	0,10-0,30
	30.22		Cast or cast and aged		900	70-140	-23/H13A	65-130	0,10-0,30
	33.1	Copper and copper alloys	Free cutting alloys Pb >1%		700	70-160	-23/H13A	65-130	0,10-0,30
	33.2		Brass and leaded bronzes Pb ≤1%		700	50-200	-23/H13A	65-130	0,10-0,30
S	20.11	Iron base	Annealed or solution treated		3000	180-230	-22/1025	20- 65	0,15-0,30
	20.21	Nickel base	Annealed or solution treated		3320	140-300	-23/1025	20- 65	0,15-0,30
	20.31	Cobalt base	Annealed or solution treated		3300	180-230	-23/H13A	20- 65	0,15-0,30
	23.21	Titanium	Alfa, near alfa and alfa + beta alloys annealed		1675	Rm <sup>9</sup> 600-1100	-23/H13A -22/1025	30-100 30-100	0,15-0,30 0,15-0,30

Graphs see page 93-94.



### Graphs for Ejector drill head 424.10

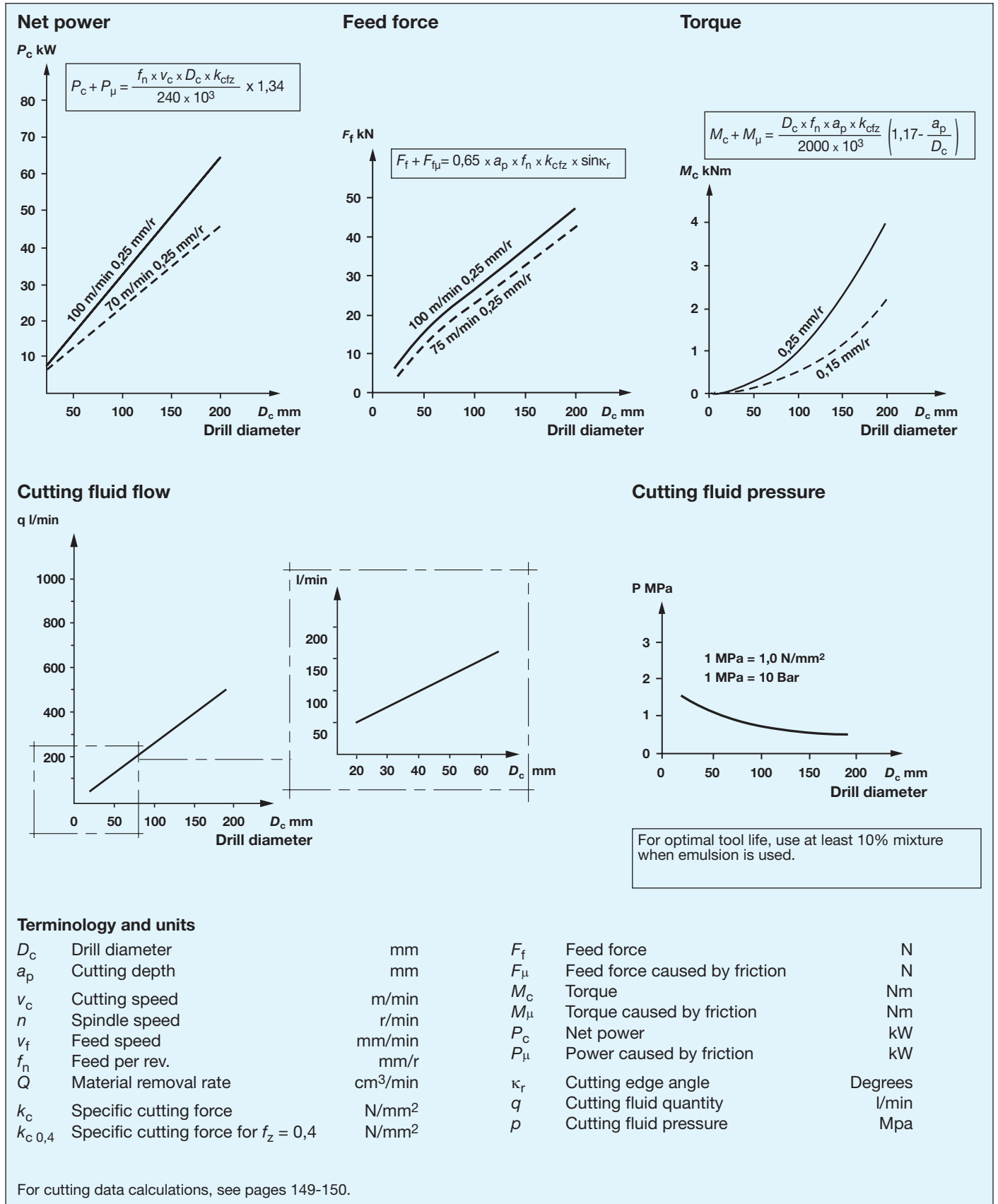

The graphs show nominal values which should not be regarded as strict recommendations. The values may need adjusting depending on the machining conditions e.g., the type of material.

Note that only net power ratings are given. Allowance must be made for the efficiency of the machine and the cutting edge wear.

### Graphs for STS drill head 424.10

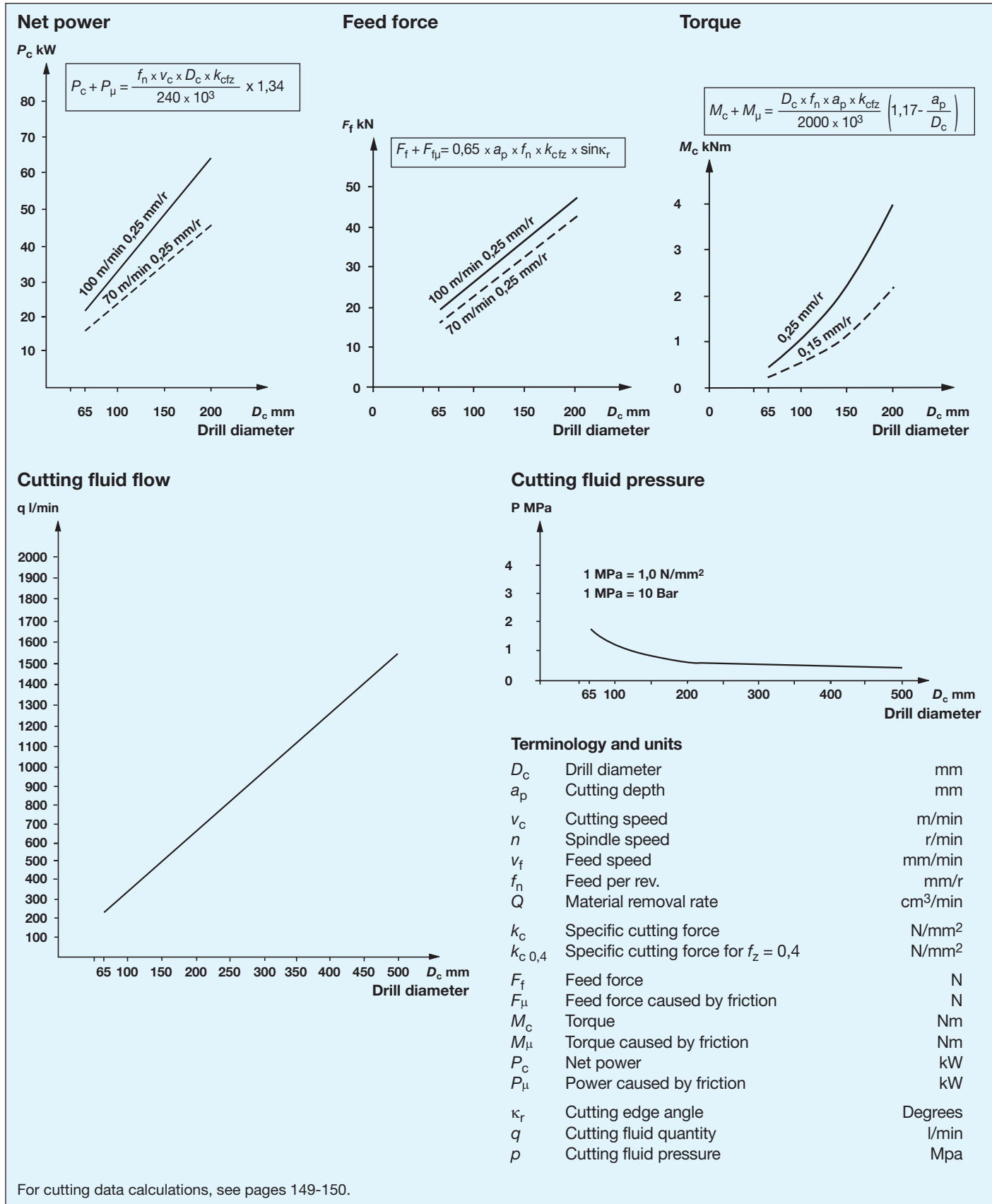

The graphs show nominal values which should not be regarded as strict recommendations. The values may need adjusting depending on the machining conditions e.g., the type of material.

Note that only net power ratings are given. Allowance must be made for the efficiency of the machine and the cutting edge wear.

Cutting data for T-MAX<sup>®</sup> counterboring heads 424.31F, 424.31 and 424.32

ISO	CMC No.	Material		Specific cutting force $k_c 0,4$ N/mm <sup>2</sup>	Hardness Brinell HB	Grade	Cutting speed $v_c$ m/min	Depth of cut, mm		
								1-3	3-8	≥ 8
								Feed, $f_n$ mm/r		
P          Steel	01.1	Unalloyed	Non-hardened 0,1-0,25% C	2000	90-200	235/4235	60-140	0,15-0,40	0,20-0,40	0,18-0,40
	01.2			2100	125-225	235/4235	60-120	0,15-0,40	0,20-0,40	0,18-0,40
	01.3			2180	150-250	235/4235	50-100	0,15-0,40	0,20-0,40	0,18-0,35
	02.1	Low alloy	Non-hardened	2100	150-260	235/4235	50-130	0,15-0,40	0,20-0,40	0,18-0,40
	02.2			2775	220-450	235/4235	50-120	0,15-0,40	0,20-0,40	0,18-0,40
	03.11	High alloy	Annealed	2500	150-250	235/4235	50-100	0,15-0,40	0,20-0,40	0,18-0,40
	03.13			2750	150-250	235/4235	50-100	0,15-0,40	0,20-0,40	0,18-0,40
	03.21			3750	250-350	235/4235	60-100	0,15-0,40	0,20-0,40	0,18-0,40
	03.22			4000	250-450	235/4235	60-100	0,15-0,40	0,20-0,40	0,18-0,40
	06.1	Castings	Unalloyed	1800	90-225	235/4235	60-120	0,20-0,40	0,20-0,40	0,18-0,40
06.2	2100			150-250	235/4235	50-110	0,20-0,40	0,20-0,40	0,18-0,40	
M  Stainless steel	05.11	Rolled/forged	Ferritic, martensitic Non-hardened	2300	150-270	235/S6	50- 95	0,20-0,40	0,20-0,40	0,18-0,40
	05.21	Rolled/forged	Austenitic	2600	150-275	235/S6	50- 95	0,20-0,40	0,20-0,40	0,18-0,40
K  Cast iron	07.1	Malleable	Ferritic	950	110-145	415/4235	60-120	0,20-0,40	0,20-0,40	0,15-0,40
	07.2			1100	150-270	415/4235	60-120	0,20-0,40	0,20-0,40	0,15-0,40
	08.1	Grey	Low tensile strength	1100	150-220	415/4235	50-120	0,20-0,40	0,20-0,40	0,15-0,40
	08.2			1290	200-330	415/4235	50-120	0,20-0,40	0,20-0,40	0,15-0,40
	09.1	Nodular	Ferritic	1050	125-230	415/4235	60-120	0,20-0,40	0,20-0,40	0,15-0,40
09.2	1750			200-300	415/4235	60-120	0,20-0,40	0,20-0,40	0,15-0,40	
N  Non-ferrous metals	30.11	Aluminium alloys	Wrought or wrought and coldworked, non aging	500	30-100	4235	65-300	0,20-0,40	0,20-0,40	0,20-0,40
	30.12			800	30-150	4235	65-300	0,20-0,40	0,20-0,40	0,20-0,40
	30.21	Aluminium alloys	Cast, non aging	750	40-100	4235	65-300	0,20-0,40	0,20-0,40	0,20-0,40
	30.22			900	70-140	4235	65-300	0,20-0,40	0,20-0,40	0,20-0,40
	33.1	Copper and copper alloys	Free cutting alloys Pb >1%	700	70-160	4235	65-300	0,20-0,40	0,20-0,40	0,20-0,40
	33.2			700	50-200	4235	65-300	0,20-0,40	0,20-0,40	0,20-0,40

Graphs see page 96.

**Graphs for T-MAX® counterboring heads 424.31F, 424.31 and 424.32**

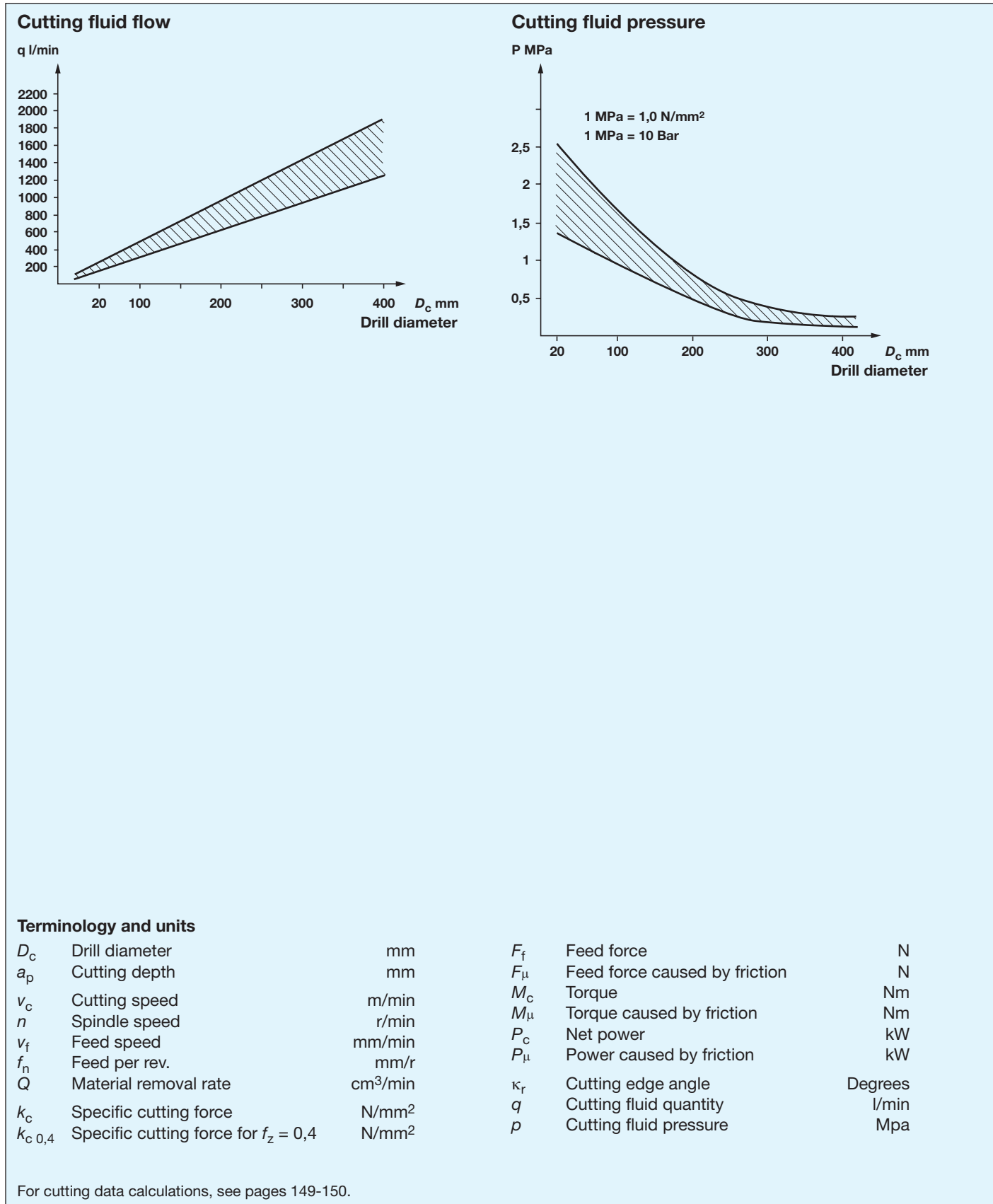

The graphs show nominal values which should not be regarded as strict recommendations. The values may need adjusting depending on the machining conditions e.g., the type of material.

Note that only net power ratings are given. Allowance must be made for the efficiency of the machine and the cutting edge wear.

## Cutting data for T-MAX® trepanning head 420.7

ISO	CMC No.	Material		Specific cutting force $k_c$ 0,4 N/mm <sup>2</sup>	Hardness Brinell HB	Geometry/grade	Cutting speed $v_c$ m/min	Drill diameter, mm
								≥ 120
								Feed, $f_n$ mm/r
P          Steel	01.1	Unalloyed	Non-hardened 0,1-0,25% C Non-hardened 0,25-0,55% C Non-hardened 0,55-0,80% C High carbon steel, annealed	2000	90-200	-22/-23/235	80-100	0,18-0,30
	01.2			2100	125-225	-22/235	80-100	0,18-0,30
	01.3			2180	150-250	-22/235	80-100	0,18-0,30
	01.4			2320	180-275	-22/235	80-100	0,18-0,30
	02.1	Low alloy	Non-hardened Hardened and tempered	2100	150-260	-22/235	70-100	0,18-0,30
	02.2			2775	220-450	-22/235	60-100	0,16-0,30
	03.11	High alloy	Annealed Annealed HSS Hardened tool steels Hardened steels, others	2500	150-250	-22/235	70-100	0,18-0,30
	03.13			2750	150-250	-22/235	70-100	0,18-0,30
	03.21			3750	250-350	-22/235	60-100	0,16-0,30
	03.22			4000	250-450	-22/235	60-100	0,16-0,30
06.1	Castings	Unalloyed Low alloyed (alloying elements <5%)	1800	90-225	-22/235	50-100	0,15-0,30	
06.2			2100	150-250	-22/235	50-100	0,15-0,30	
M  Stainless steel	05.11	Rolled/forged	Ferritic, martensitic Non-hardened	2300	150-270	-22/235	50- 90	0,16-0,30
	05.21	Rolled/forged	Austenitic	2600	150-275	-23/235	50- 90	0,16-0,30
K  Cast iron	07.1	Malleable	Ferritic Pearlitic	950	110-145	-23/H13A	80-100	0,18-0,30
	07.2			1100	150-270	-23/H13A	80-100	0,18-0,30
	08.1	Grey	Low tensile strength High tensile strength	1100	150-220	-23/H13A	60-100	0,16-0,30
	08.2			1290	200-330	-23/H13A	60-100	0,16-0,30
	09.1	Nodular	Ferritic Pearlitic	1050	125-230	-23/H13A	50-100	0,16-0,30
09.2	1750			200-300	-23/H13A	50-100	0,16-0,30	
N  Non-ferrous metals	30.11	Aluminium alloys	Wrought or wrought and coldworked, non aging Wrought or wrought and aged	500	30-100	-23/H13A	65-130	0,10-0,30
	30.12			800	30-150	-23/H13A	65-130	0,10-0,30
	30.21	Aluminium alloys	Cast, non aging Cast or cast and aged	750	40-100	-23/H13A	65-130	0,10-0,30
	30.22			900	70-140	-23/H13A	65-130	0,10-0,30
	33.1	Copper and copper alloys	Free cutting alloys Pb >1% Brass and leaded bronzes Pb ≤1%	700	70-160	-23/H13A	65-130	0,10-0,30
	33.2			700	50-200	-23/H13A	65-130	0,10-0,30

Graphs see page 98.

## Graphs for T-MAX® trepanning head 420.7

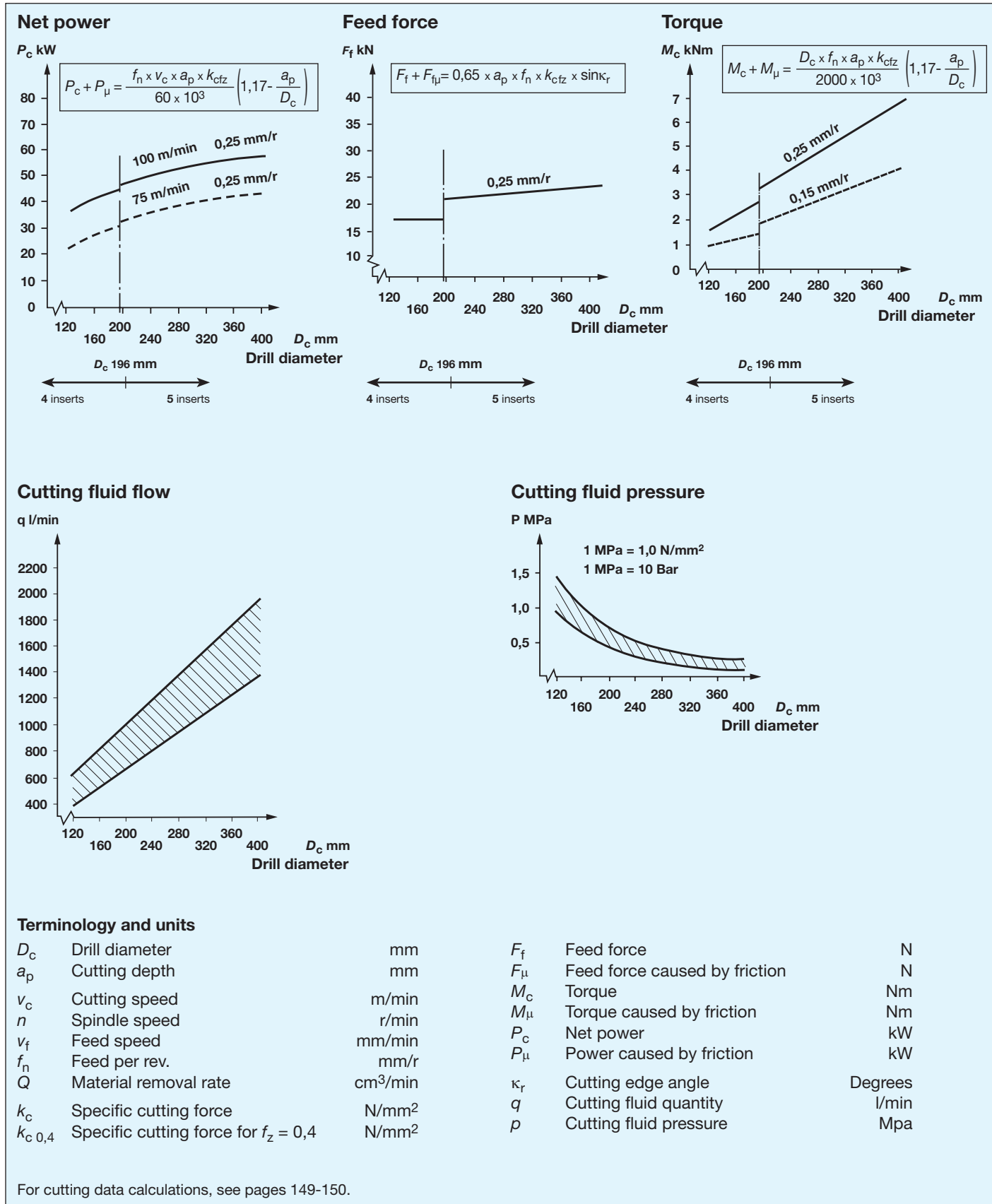

The graphs show nominal values which should not be regarded as strict recommendations. The values may need adjusting depending on the machining conditions e.g., the type of material.

Note that only net power ratings are given. Allowance must be made for the efficiency of the machine and the cutting edge wear.

## Spare parts for CoroDrill® 800 solid drill heads

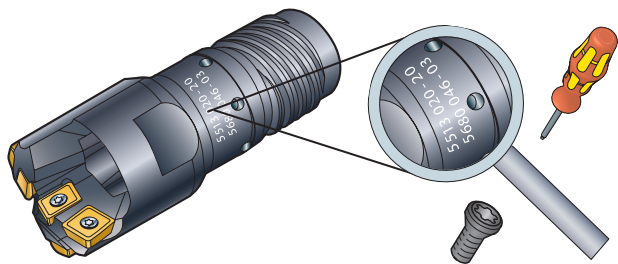

Drill head	Insert – C, I, P <sup>1)</sup>			Support pad			
	Metric (Inch)	Drill diameter range, mm (inch)	Screw Central	Key (Torx Plus)	Pad	Screw	Key (Torx Plus)
<b>800.20-xxDxx.xx</b> <b>(A800.20-xxDxx.xx)</b>		25,00–28,70 (.964–1.129)	5513 020-05	5680 046-03 (7IP)	<b>06A</b>	5513 020-20	5680 046-03 (7IP)
<b>800.24-xxDxx.xx</b> <b>(A800.24-xxDxx.xx)</b>		28,71–31,00 (1.130–1.220)	5513 020-05 5513 020-34	5680 046-03 (7IP) 5680 046-01 (8IP)	<b>07A</b>	416.1-832	5680 046-04 (9IP)
		31,01–65,00 (1.121–2.559)	5513 020-34	5680 046-01 (8IP)	<b>08A</b>	5513 020-16	5680 046-05 (10IP)
					<b>10A – 12A</b>	416.1-833	5680 046-05 (10IP)

<sup>1)</sup> C= Central, I= Intermediate, P= Peripheral

Drill diameter range – insert and pad sizes, (ordered separately).

Ordering example: 10 pieces 5513 020-20

## Wrench width of jaws

Diameter range, mm	Width of jaws, mm	Note!
$D_C$ mm	s	
25,00 <– ≤27,00	22,00	<p>There are no specific wrenches for the CoroDrill 800 heads. An adjustable wrench, or a regular box wrench, should be used. The width of the jaws for each drill is shown in the table below.</p> 
27,00 <– ≤30,00	24,00	
30,00 <– ≤32,00	27,00	
32,00 <– ≤35,00	28,00	
35,00 <– ≤36,20	30,00	
36,20 <– ≤39,60	32,00	
39,60 <– ≤43,00	36,00	
43,00 <– ≤47,00	38,00	
47,00 <– ≤51,70	41,00	
51,70 <– ≤54,00	46,00	
54,00 <– ≤56,20	50,00	
56,20 <– ≤60,00	50,00	
60,00 <– ≤63,00	55,00	
63,00 <– ≤65,00	60,00	



**Spare parts for T-MAX® solid drill head 424.10**

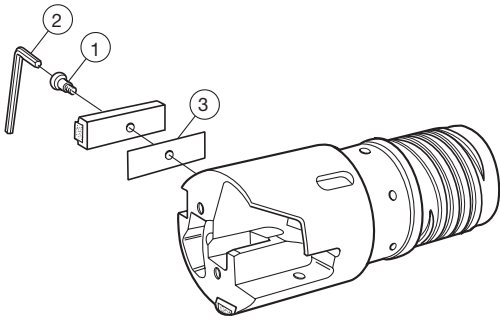

Support pad	1 <sup>1)</sup>	2 <sup>2)</sup>	3 <sup>2)</sup>	
	Screw	Key (Torx Plus)	Shim	(Thickness)
<b>430.32-12 D</b>	5513 020-01	5680 043-13 (15IP)	5549 127-01	(0,10)
			5549 127-02	(0,20)
			5549 127-03	(0,30)
<b>430.32-16 D</b>	5513 020-26	5680 043-14 (20IP)	5549 126-01	(0,10)
			5549 126-02	(0,20)
			5549 126-03	(0,30)

1) Delivered with pads.

2)- Not delivered with the pad, must be ordered separately.

**T-MAX® U cartridges**

**Central cartridge  
L430.31**

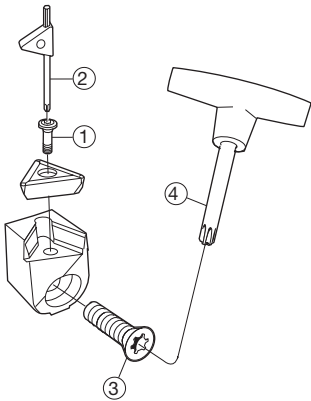

**Intermediate cartridge  
R430.30**

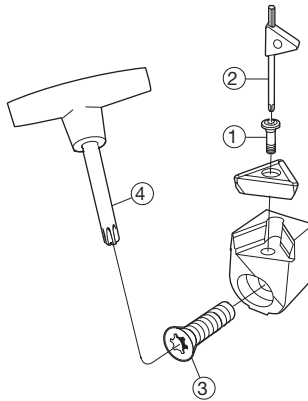

**Peripheral cartridge  
R430.28**

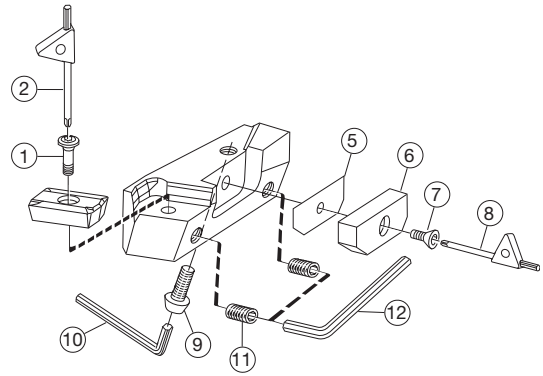

Central cartridge	Intermediate cartridge	1	2	3	4
		Screw	Key (Torx Plus)	Screw	Key (Torx Plus)
<b>L430.31-1216-16</b>	<b>R430.30-1216-16</b>	5513 020-04	5680 049-03 (9IP)	5513 020-26	5680 048 03 (20IP)
<b>L430.31-1522-22</b>	<b>R430.30-1522-22</b>	5513 020-25	5680 049-02 (15IP)	5513 020-26	5680 048 03 (20IP)

Peripheral cartridge	1	2	5	6	7	8	9	10	11	12
	Screw	Key (Torx Plus)	Shim (mm)	Insert protection pad	Screw	Key (Torx Plus)	Screw	Key (mm)	Screw	Key (mm)
<b>R430.28-1516-16</b>	5513 020-24	5680 049-03 (9IP)	5549 024-01 (0,1) 5549 024-02 (0,2) 5549 024-03 (0,4) 5549 024-04 (0,8)	5636 030-01	154.3-835	5680 049-03 (9IP)	430.21-825	3021 010-040 (4,0)	3214 010-357	174.1-864 (3,0)
<b>R430.28-1822-22</b>	5513 020-25	5680 049-02 (15IP)	5549 024-05 (0,1) 5549 024-06 (0,2) 5549 024-07 (0,4) 5549 024-08 (0,8)	5636 030-02	154.3-835	5680 049-03 (9IP)	430.21-825	3021 010-040 (4,0)	3214 010-357	174.1-864 (3,0)

Ordering example: 10 pieces 5513 020-24

### Spare parts for T-MAX® counterboring heads 424.31F

Diameter range 20,00–43,00 mm

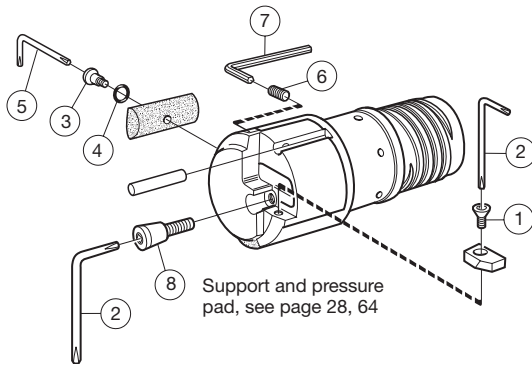

Diameter range 43,01–124,00 mm

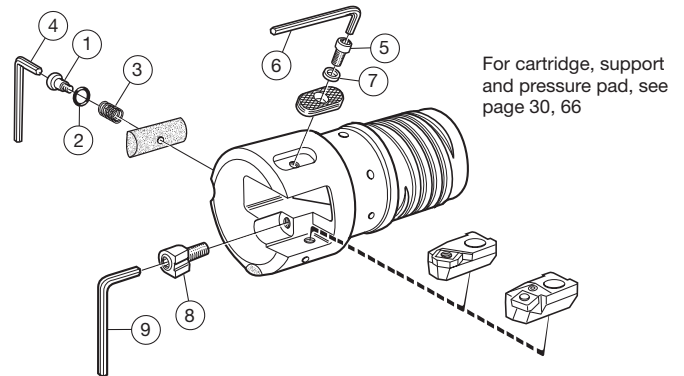

Diameter range 20,00–43,00 mm

Diameter range, mm	1	2	3	4	5	6	7	8
$D_C$ mm	Screw	Key (Torx Plus)	Screw	O-ring	Key (Torx Plus)	Screw	Key (mm)	Screw
20,00–31,00	416.1-830	5680 046-03 (7IP)	5513 030-01 <sup>1)</sup>	5641 001-13 <sup>1)</sup>	5680 051-01 <sup>1)</sup> (7IP)	3214 040-154 <sup>1)</sup>	3021 012-013 <sup>1)</sup> (1,27)	5513 014-01
31,01–43,00	416.1-830	5680 046-03 (7IP)	5513 030-02 <sup>1)</sup>	5641 001-13 <sup>1)</sup>	5680 051-01 <sup>1)</sup> (7IP)	3214 040-206 <sup>1)</sup>	174.1-862 <sup>1)</sup> (1,5)	5513 014-01

Ordering example: 10 pieces 416.1-830

Diameter range 43,01–124,00 mm

Diameter range, mm	1	2	3	4	5	6	7	8	9
$D_C$ mm	Screw	O-ring	Spring	Key (mm)	Screw	Key (mm)	Washer	Wedge set	Key (mm)
43,01– 65,00	5513 011-01 <sup>1)</sup>	3671 010-110 <sup>1)</sup>	–	174.1-870 <sup>1)</sup> (2,0)	3213 010-206 <sup>1)</sup>	174.1-870 <sup>1)</sup> (2,0)	–	5332 040-011	174.1-864 (3,0)
65,00– 79,99	430.21-820 <sup>1)</sup>	–	430.21-821 <sup>1)</sup>	174.1-864 (3,0)	3212 010-207	174.1-863 (2,5)	3411 010-032	5332 040-011	174.1-864 (3,0)
80,00– 89,99	430.21-820 <sup>1)</sup>	–	430.21-821 <sup>1)</sup>	174.1-864 (3,0)	3212 010-307	3021 010-040 (4,0)	3411 011-053	5332 040-011	174.1-864 (3,0)
90,00–124,99	430.21-820 <sup>1)</sup>	–	430.21-821 <sup>1)</sup>	174.1-864 (3,0)	3212 010-358	3021 010-050 (5,0)	3411 011-064	5332 040-011	174.1-864 (3,0)

<sup>1)</sup> Delivered with pad.

Ordering example: 10 pieces 5513 011-01

### Cartridges for T-MAX® counterboring heads 424.31F

R430.24-1118-06

Cartridge for close tolerances

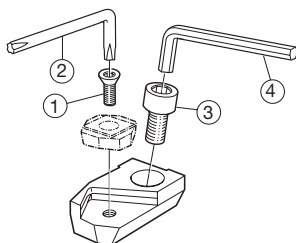

1	2	3	4
Screw	Key (Torx Plus)	Screw	Key (mm)
416.1-833	5680 046-05 (10IP)	3212 010-307	3021 010-040 (4,0)

R430.24-1018-09

Cartridge for normal tolerances

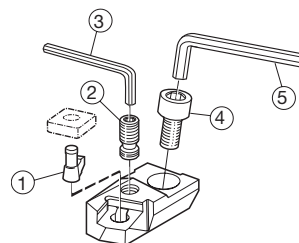

1	2	3	4	5
Lever	Screw	Key (mm)	Screw	Key (mm)
174.3-845-1	174.3-829	174.1-870 (2,0)	3212 010-307	3021 010-040 (4,0)

Ordering example: 10 pieces 416.1-833

## Spare parts for T-MAX<sup>®</sup> counterboring heads 424.31

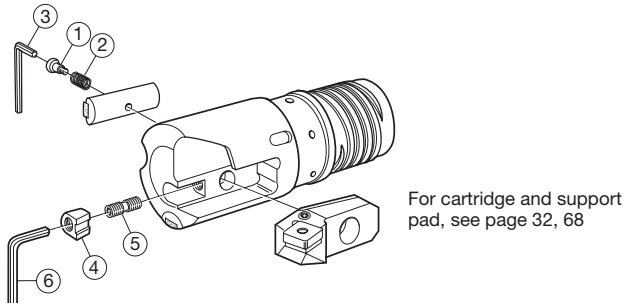

Diameter range, mm	1 <sup>1)</sup>	2 <sup>1)</sup>	3	4	5	6
$D_C$ mm	Screw	Spring	Key (mm)	Wedge	Screw	Key (mm)
65,00–278,99	430.21-820	430.21-821	174.1-864 (3,0)	430.23-820	269-833	3021 010-040 (4,0)
279,00–	430.21-823	430.21-824	3021 010-040 (4,0)	430.23-820	269-833	3021 010-040 (4,0)

1<sup>1)</sup>- Delivered with pad.

Ordering example: 10 pieces 430.21-820

## Cartridges for T-MAX<sup>®</sup> counterboring heads 424.31

### T-MAX<sup>®</sup> P lever design cartridge R430.24

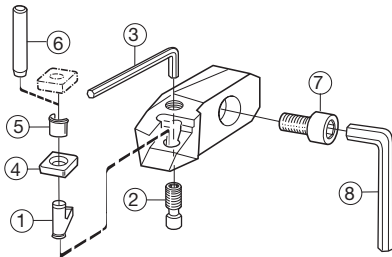

### T-MAX<sup>®</sup> S top clamp design cartridge R430.23

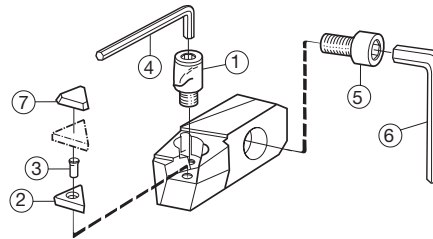

T-MAX P Cartridge R430.24	1	2	3	4	5	6	7	8
	Lever	Screw	Key (mm)	Shim	Shim pin	Shim pin punch	Screw	Key (mm)
R430.24-2024-12	174.3-841M (3,0)	174.3-821	174.1-864 (6,0)	174.3-851M	174.3-861	174.3-871	3212 010-412	3021 010-060 <sup>1)</sup>
R430.24-2532-19	174.3-842M (4,0)	174.3-822M	3021 010-040 (8,0)	174.3-852M	174.3-862	174.3-872	3212 010-464	3021 010-080 <sup>1)</sup>

T-MAX S Cartridge R430.23	1	2	3	4	5	6
	Clamp set	Shim	Shim pin	Key (mm)	Screw	Key (mm)
R430.23-2024-16	174.9-837-1	175.2-850	174.1-865	174.1-864 (3,0)	3212 010-412	3021 010-060 <sup>1)</sup> (6,0)
R430.23-2532-22	174.9-838-1	175.2-851	174.1-866	3021 010-040 (4,0)	3212 010-464	3021 010-080 <sup>1)</sup> (8,0)

1<sup>1)</sup>-Supplied on request

Ordering example: 10 pieces 174.9-837-1

## Optional parts

Cartridge	Are to be used for TPUN inserts and loose chipbreaker. Available separately.			
	1	4	7	
	Clamp set	Key (mm)	Chipbreaker	
R430.23-2024-16	174.9-833-2	174.1-864 (3,0)	DO 212 H35 (B = 1,2 mm)	DO 220 H35 (B = 2,0 mm)
R430.23-2532-22	174.9-835-1	3021 010-040 (4,0)	DO 320 H35 (B = 2,0 mm)	DO 325 H35 (B = 2,5 mm)

Ordering example: 10 pieces 174.9-833-2

### Spare parts for T-MAX<sup>®</sup> trepanning head 420.7

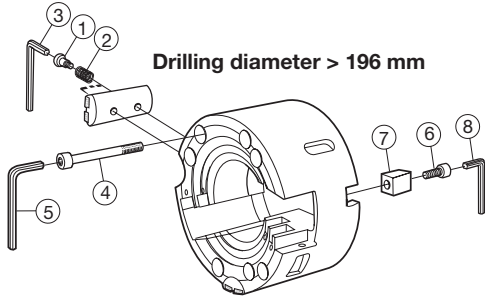

Support pad set	1 <sup>1)</sup>	2 <sup>1)</sup>	3
	Screw	Spring	Key (mm)
430.21-12 D 430.21-16 D 430.21-18 D	430.21-820	430.21-821	174.1-864 (3,0)

<sup>1)</sup>Delivered with pad.

4	5	6	7	8
Screw	Key (mm)	Screw	Wedge	Key (mm)
3212 010-473 (8,0)	3021 010-080	3212 010-396	420.7-820 (5,0)	3021 010-050 (8,0)

Ordering example: 10 pieces 430.21-820

### T-MAX<sup>®</sup> U cartridges

#### Central cartridge L430.27

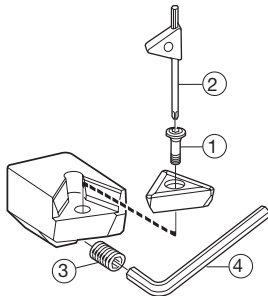

#### Peripheral cartridge R430.28

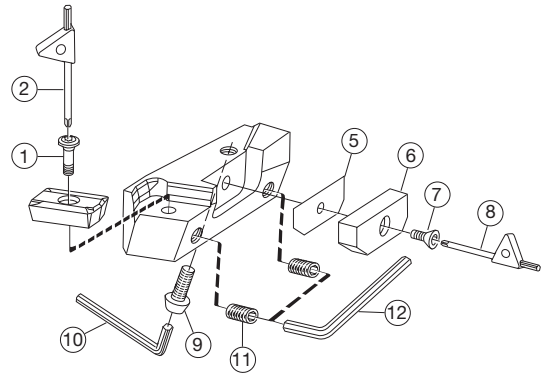



Central cartridge	1	2	3	4
	Screw	Key (Torx Plus)	Screw	Key (mm)
L430.27-1216-16	5513 020-24	5680 049-03 (9IP)	437.5-822	174.1-864 (3,0)
L430.27-1522-22	5513 020-25	5680 049-02 (15IP)	437.5-822	174.1-864 (3,0)

Peripheral cartridge	1	2	5	6	7	8	9	10	11	12
	Screw	Key (Torx Plus)	Shim (mm)	Insert protection pad	Screw	Key (Torx Plus)	Screw	Key (mm)	Screw	Key (mm)
R430.28-1516-16	5513 020-24	5680 049-03 (9IP)	5549 024-01 (0,1) 5549 024-02 (0,2) 5549 024-03 (0,4) 5549 024-04 (0,8)	5636 030-01	154.3-835	5680 049-03 (9IP)	430.21-825	3021 010-040 (4,0)	3214 010-357	174.1-864 (3,0)
R430.28-1822-22	5513 020-25	5680 049-02 (15IP)	5549 024-05 (0,1) 5549 024-06 (0,2) 5549 024-07 (0,4) 5549 024-08 (0,8)	5636 030-02	154.3-835	5680 049-03 (9IP)	430.21-825	3021 010-040 (4,0)	3214 010-357	174.1-864 (3,0)

Ordering example: 10 pieces 5513 020-24

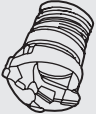
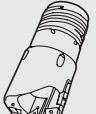
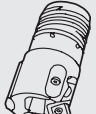
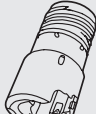
## Hook spanners for deep hole drills

Solid drill head 424.6 and 420.6	Solid drill head 424.10 Counterboring head 424.32	Counterboring head 424.31F	Trepanning head 420.7	Hook spanner  (DIN 1810)
 $D_c$ 24,11–26,40 26,41–33,30 33,31–36,20 36,21–43,00 43,01–47,00 47,01–56,20 56,21–62,80 62,81–65,00 – – – – – – – – – –	 $D_c$ – – – – – – – 65, 65E, 70 75, 80 85, 90, 95 100, 105, 110 115, 120 125, 130 150 160, 170 180	 $D_c$ 20,00– 23,40 23,41– 31,00 31,01– 35,00 35,01– 40,00 40,01– 47,00 47,01– 55,00 55,01– 60,00 60,01– 72,90 73,00– 79,90 80,00– 99,90 100,00–111,90 112,00–123,90 – – – –	 $D_c$ – – – – – – – – – 120 125, 130, 140 150 160 180	 (DIN 1810) 3022 010-016 3022 010-025 3022 010-030 3022 010-034 3022 010-040 3022 010-045 3022 010-052 3022 010-058 3022 010-068 3022 010-080 3022 010-095 3022 010-110 3022 010-120 3022 010-135 3022 010-155 3022 010-180

### Spare parts for obsolete tools T-MAX® solid drill head 424.9

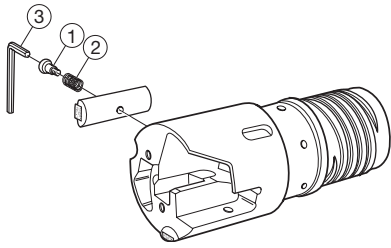

		P		M		K		N	
		GC	-	GC	-	GC	-	GC	-
		235	S6	235	S6	4235	-	4235	-
	TPMX	★ = First choice							
16	TPMX	16 03 12 R22	★	☆	★	☆			
22	TPMX	22 04 12 R22	★	☆	★	☆			
16	TPUN	16 03 12	★	☆	★	☆	★		★
22	TPUN	22 04 12	★	☆	★	☆	★		★

Support pad set	1	2	3
	Screw	Spring	Key (mm)
430.21-12 D 430.21-16 D 430.21-18 D	430.21-820	430.21-821	174.1-864 (3,0)

Ordering example: 10 pieces 430.21-820

#### Central cartridge L430.27

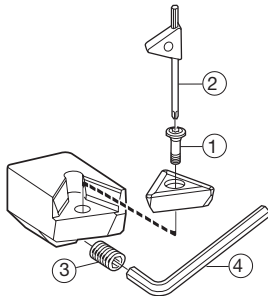

#### Intermediate cartridge R430.26

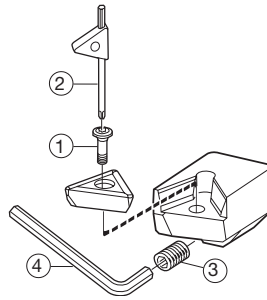

#### Peripheral cartridge R430.28

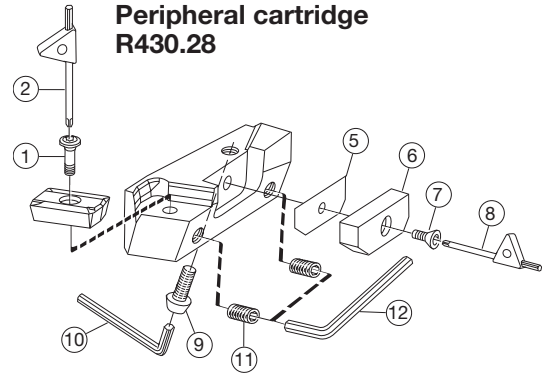

Central cartridge	Intermediate cartridge	1	2	3	4
		Screw	Key (Torx Plus)	Screw	Key (mm)
L430.27-1216-16	R430.26-1216-16	5513 020-24	5680 049-03 (9IP)	437.5-822	174.1-864 (3,0)
L430.27-1522-22	R430.26-1522-22	5513 020-25	5680 049-02 (15IP)	437.5-822	174.1-864 (3,0)

Peripheral cartridge	1	2	5	6	7	8	9	10	11	12
	Screw	Key (Torx Plus)	Shim (mm)	Insert protection pad	Screw	Key (Torx Plus)	Screw	Key (mm)	Screw	Key (mm)
R430.28-1516-16	5513 020-24	5680 049-03 (9IP)	5549 024-01 (0,1) 5549 024-02 (0,2) 5549 024-03 (0,4) 5549 024-04 (0,8)	5636 030-01	154.3-835	5680 049-03 (9IP)	430.21-825	3021 010-040 (4,0)	3214 010-357	174.1-864 (3,0)
R430.28-1822-22	5513 020-25	5680 049-02 (15IP)	5549 024-05 (0,1) 5549 024-06 (0,2) 5549 024-07 (0,4) 5549 024-08 (0,8)	5636 030-02	154.3-835	5680 049-03 (9IP)	430.21-825	3021 010-040 (4,0)	3214 010-357	174.1-864 (3,0)

Ordering example: 10 pieces 5513 020-24

## Rotating connectors

424.2-401M, 424.2-400M, 424.2-400M-V63

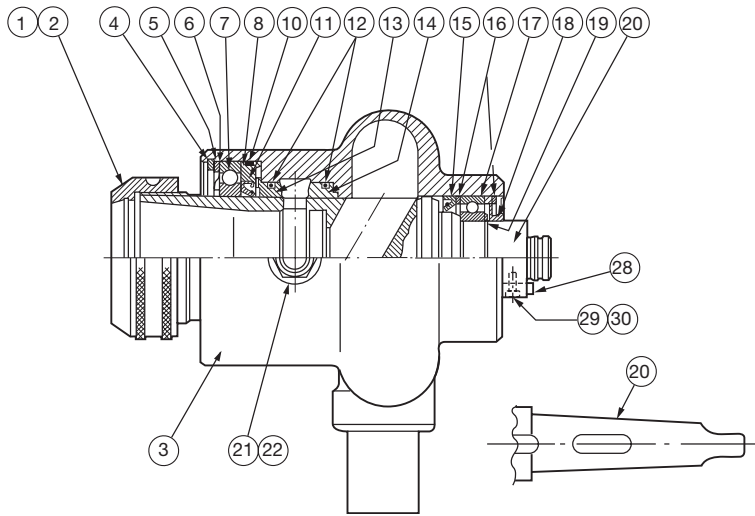

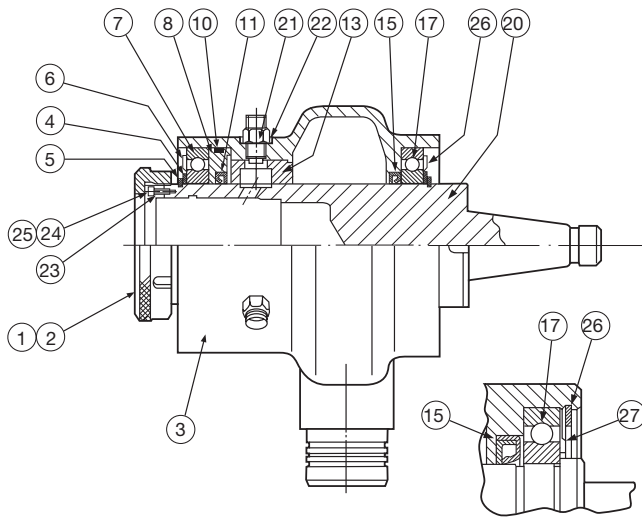

### 424.2-402



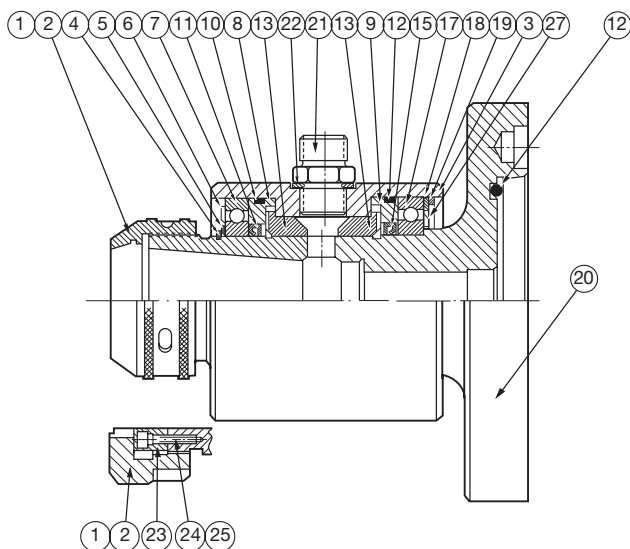

424.9S/231-1 424.9S/224-1  
424.9S/170-1 424.9S/245-1





Type of shank	Connector code	1	2
			
		Nut	Hook spanner
Varilock adapted	424.2-400M-V63	424.2-400-01	3022 010-110
Morse taper	424.2-401M 400M	424.2-401-01 424.2-400-01	3022 010-080 3022 010-110
ISO taper	424.2-402	424.2-402-03	3022 010-155
Flange mounting	424.9S/231-1 <sup>1)</sup> 424.9S/170-1 <sup>1)</sup> 424.9S/224-1 <sup>1)</sup> 424.9S/245-1 <sup>1)</sup>	424.2-401-01 424.2-400-01 424.2-402-03 424.2-403-03	3022 010-080 3022 010-110 3022 010-155 3022 010-230







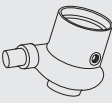

<sup>1)</sup> For information, please contact your nearest Sandvik representative.

Type of shank	Connector code	11	12
			
		Sealing ring	O-ring
Varilock adapted	424.2-400M-V63	424.2-400-27	424.2-400-28
Morse taper	424.2-401M 400M	424.2-401-27 424.2-400-27	424.2-401-28 424.2-400-28
ISO taper	424.2-402	B1 130 × 160 × 12	-
Flange mounting	424.9S/231-1 <sup>1)</sup> 424.9S/170-1 <sup>1)</sup> 424.9S/224-1 <sup>1)</sup> 424.9S/245-1 <sup>1)</sup>	BA 70×85×7 <sup>1)</sup> B2 95×120×15 <sup>1)</sup> B1 130×160×12 <sup>1)</sup> B1 200×230×15 <sup>1)</sup>	109,5 × 3 <sup>1)</sup> 144,5 × 3 <sup>1)</sup> 199,3 × 5,7 <sup>1)</sup> 319,3 × 5,7 <sup>1)</sup>

<sup>1)</sup> For information, please contact your nearest Sandvik representative.









Type of shank	Connector code	21	22
			
		Nipple	Sealing ring
Varilock adapted	424.2-400M-V63	424.2-400-29	3672 020-270
Morse taper	424.2-401M 400M	424.2-401-29 424.2-400-29	3672 020-215 3672 020-270
ISO taper	424.2-402	424.2-402-07	U36,7 × 46 × 2
Flange mounting	424.9S/231-1 <sup>1)</sup> 424.9S/170-1 <sup>1)</sup> 424.9S/224-1 <sup>1)</sup> 424.9S/245-1 <sup>1)</sup>	424.2-401-29 424.2-400-29 424.2-402-07 424.2-403-07	3672 020-270 3672 020-270 U36,7 × 46 × 2 U42,7 × 53 × 3



3		4		5		6		7		8		9		10	
Housing		Circlip <sup>2)</sup>		Clamping ring		Sealing washer		Ball bearing		Support ring		Support ring		O-ring	
424.2-400-10M		424.2-400-12(H)		424.2-400-03M		424.2-400-04		424.2-400-25		424.2-400-20		-		424.2-400-26	
424.2-401-10M		424.2-401-12(H)		424.2-401-03M		424.2-401-04		424.2-401-25		424.2-401-20		-		424.2-401-26	
424.2-400-10M		424.2-400-12(H)		424.2-400-03M		424.2-400-04		424.2-400-25		424.2-400-20		-		424.2-400-26	
424.2-402-01		3421 100-130(A)		424.2-402-04		23126 AV		SKF 16026		424.2-402-05		-		3671 010-162	
424.9S/231-7 <sup>1)</sup>		SgA 70(A) <sup>1)</sup>		424.9S/231-2 <sup>1)</sup>		16014 AV <sup>1)</sup>		SKF 16014		424.9S/231-3 <sup>1)</sup>		424.9S/231-5 <sup>1)</sup>		104,5 × 3 <sup>1)</sup>	
424.9S/170-8 <sup>1)</sup>		SgA 95(A) <sup>1)</sup>		424.9S/170-2 <sup>1)</sup>		16019 AV <sup>1)</sup>		SKF 16019		424.9S/170-3 <sup>1)</sup>		424.9S/170-5 <sup>1)</sup>		139,5 × 3 <sup>1)</sup>	
424.9S/224-3 <sup>1)</sup>		3421 100-130(A)		424.2-402-04		23126 AV		SKF 16026		424.2-402-05		424.9S/224-2 <sup>1)</sup>		3671 010-162	
424.9S/245-3 <sup>1)</sup>		3421 100-200(A)		424.2-403-04		16040 AV		SKF 16040		424.2-403-05		424.9S/245-2 <sup>1)</sup>		3671 010-174	









<sup>1)</sup> For information, please contact your nearest Sandvik representative.

<sup>2)</sup> (H) = For hole (A) = For shank

13		14		15		16		17		18		19		20	
Spacing rings outer		inner		Sealing ring		Circlip <sup>2)</sup>		Ball bearing		Sealing sleeve		Circlip <sup>2)</sup>		Shank	
424.2-400-21		424.2-400-23		424.2-400-08		424.2-400-14(H)		424.2-400-15		424.2-400-09		424.2-400-16(A)		5622 033-01	
424.2-401-21		424.2-401-23		424.2-401-08		424.2-401-14(H)		424.2-401-15		424.2-401-09		424.2-401-16(A)		424.2-401-11M	
424.2-400-21		424.2-400-23		424.2-400-08		424.2-400-14(H)		424.2-400-15		424.2-400-09		424.2-400-16(A)		424.2-400-11M	
424.2-402-06		-		B2 FG135 × 170 × 15		-		SKF 16028		-		-		424.2-402-02	
424.9S/231-4 <sup>1)</sup>		-		BA75×90×8 <sup>1)</sup>		-		SKF 16015 <sup>1)</sup>		424.9S/231-6 <sup>1)</sup>		SgH 115(H) <sup>1)</sup>		Depending on spindle nose type and size	
424.9S/170-4 <sup>1)</sup>		-		B2 100×120×15 <sup>1)</sup>		-		SKF 16020 <sup>1)</sup>		424.9S/170-6 <sup>1)</sup>		SgH 150(H) <sup>1)</sup>			
424.2-402-06 <sup>1)</sup>		-		B2 FG135×170×15 <sup>1)</sup>		-		SKF 16028		-		3221 110-210(H)			
424.2-403-06 <sup>1)</sup>		-		B2 210×240×15 <sup>1)</sup>		-		SKF 16044 <sup>1)</sup>		-		-			

<sup>1)</sup> For information, please contact your nearest Sandvik representative.

<sup>2)</sup> (H) = For hole (A) = For shank

23		24		25		26		27		28		29		30	
Driving key		Screw		Key (mm)		Circlip <sup>2)</sup>		Sealing washer		Driving key		Screw		Key (mm)	
-		-		-		-		-		5631 010-05		3212 010-358		3021 010-050 (5,0)	
-		-		-		-		-		-		-		-	
-		-		-		-		-		-		-		-	
424.2-402-08		3212 010-310		3021 010-040 (4,0)		3421 110-210(H)		16028 JV		-		-		-	
-		-		-		-		16015 JV		-		-		-	
-		-		-		-		16020 JV		-		-		-	
424.2-402-08		3212 010-310		3021 010-040 (4,0)		-		16028 JV		-		-		-	
424.2-403-08		3212 010-362		3021 010-050 (5,0)		-		424.9S/245-5 <sup>1)</sup>		-		-		-	

<sup>1)</sup> For information, please contact your nearest Sandvik representative.

<sup>2)</sup> (H) = For hole (A) = For shank

Ordering example: 2 pieces 424.2-400-01

## Non-rotating connectors

### Cylindrical

424.2-411  
424.2-410

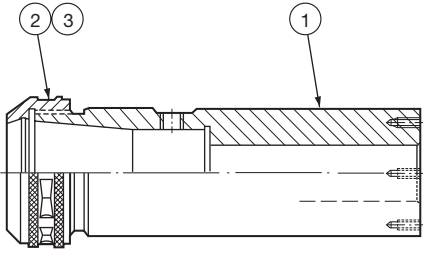

### Cylindrical

424.2-412  
424.2-413

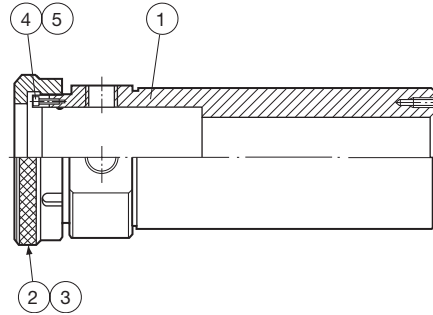





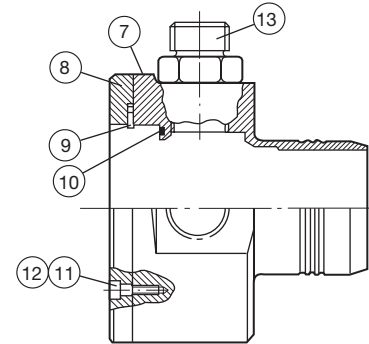

### Drill tube mounted

424.9S/232-1









### Cylindrical

Connector	1	2	3	4	5	6
						
	Shank	Nut	Hook spanner	Driving key	Screw	Key (mm)
<b>424.2-411</b>	424.2-411-01	424.2-401-01	3022 010-080	-	-	-
<b>410</b>	424.2-410-01	424.2-400-01	3022 010-110	-	-	-
<b>412</b>	424.2-412-01	424.2-402-03	3022 010-155	424.2-402-08	3212 010-310	3021 010-040 (4,0)
<b>413</b>	424.2-413-01	424.2-403-03	3022 010-230	424.2-403-08	3212 010-362	3021 010-050 (5,0)

Ordering example: 2 pieces 424.2-411-01

### Drill tube mounted

Connector	7	8	9	10	11	12	13
							
	Body	Cover	Circlip	O-ring	Screw	Key (mm)	Nipple
<b>424.9S/232-1-14</b>	424.9S/232-2-14 <sup>1)</sup>	424.9S/232-3-14 <sup>1)</sup>	SgA 56 <sup>1)</sup>	49,5 × 3 <sup>1)</sup>	3212 010-360	3021 010-050 (5,0)	BSP04000-16 <sup>1)</sup>
<b>424.9S/232-1-15</b>	424.9S/232-2-15 <sup>1)</sup>	424.9S/232-3-15 <sup>1)</sup>	SgA 62 <sup>1)</sup>	54,5 × 3 <sup>1)</sup>	3212 010-360	3021 010-050 (5,0)	BSP04000-16 <sup>1)</sup>
<b>424.9S/232-1-16</b>	424.9S/232-2-16 <sup>1)</sup>	424.9S/232-3-16 <sup>1)</sup>	SgA 68 <sup>1)</sup>	59,5 × 3 <sup>1)</sup>	3212 010-360	3021 010-050 (5,0)	BSP04000-16 <sup>1)</sup>
<b>424.9S/232-1-17</b>	424.9S/232-2-17 <sup>1)</sup>	424.9S/232-3-17 <sup>1)</sup>	SgA 75 <sup>1)</sup>	64,5 × 3 <sup>1)</sup>	3212 010-360	3021 010-050 (5,0)	BSP04000-16 <sup>1)</sup>
<b>424.9S/232-1-18</b>	424.9S/232-2-18 <sup>1)</sup>	424.9S/232-3-18 <sup>1)</sup>	SgA 82 <sup>1)</sup>	74,5 × 3 <sup>1)</sup>	3212 010-360	3021 010-050 (5,0)	BSP04000-16 <sup>1)</sup>
<b>424.9S/232-1-19</b>	424.9S/232-2-19 <sup>1)</sup>	424.9S/232-3-19 <sup>1)</sup>	SgA 95 <sup>1)</sup>	84,5 × 3 <sup>1)</sup>	3212 010-360	3021 010-050 (5,0)	BSP04000-16 <sup>1)</sup>
<b>424.9S/232-1-20</b>	424.9S/232-2-20 <sup>1)</sup>	424.9S/232-3-20 <sup>1)</sup>	SgA 105 <sup>1)</sup>	99,5 × 3 <sup>1)</sup>	3212 010-360	3021 010-050 (5,0)	BSP04000-16 <sup>1)</sup>
<b>424.9S/232-1-21</b>	424.9S/232-2-21 <sup>1)</sup>	424.9S/232-3-21 <sup>1)</sup>	SgA 118 <sup>1)</sup>	109,5 × 3 <sup>1)</sup>	3212 010-410	3021 010-060 (6,0)	BSP04000-20 <sup>1)</sup>
<b>424.9S/232-1-22</b>	424.9S/232-2-22 <sup>1)</sup>	424.9S/232-3-22 <sup>1)</sup>	SgA 130 <sup>1)</sup>	119,5 × 3 <sup>1)</sup>	3212 010-410	3021 010-060 (6,0)	BSP04000-20 <sup>1)</sup>
<b>424.9S/232-1-23</b>	424.9S/232-2-23 <sup>1)</sup>	424.9S/232-3-23 <sup>1)</sup>	SgA 140 <sup>1)</sup>	134,5 × 3 <sup>1)</sup>	3212 010-410	3021 010-060 (6,0)	BSP04000-20 <sup>1)</sup>
<b>424.9S/232-1-24</b>	424.9S/232-2-24 <sup>1)</sup>	424.9S/232-3-24 <sup>1)</sup>	SgA 155 <sup>1)</sup>	144,5 × 3 <sup>1)</sup>	3212 010-410	3021 010-060 (6,0)	BSP04000-20 <sup>1)</sup>
<b>424.9S/232-1-25</b>	424.9S/232-2-25 <sup>1)</sup>	424.9S/232-3-25 <sup>1)</sup>	SgA 165 <sup>1)</sup>	154,5 × 3 <sup>1)</sup>	3212 010-410	3021 010-060 (6,0)	BSP04000-20 <sup>1)</sup>

<sup>1)</sup> For information, please contact your nearest Sandvik representative.

Ordering example: 2 pieces 424.9S/232-2-14

# CoroDrill® 805

Deep holes in conventional machines



The CoroDrill 805 makes it possible to drill deep holes without moving the workpiece to a dedicated deep hole drilling machine i.e. all operations can be completed in one set-up.

Deep holes can be performed with high productivity and reliability achieving a hole quality comparable with traditional deep hole drilling. Another advantage is that no extra pump capacity is required.

CoroDrill 805 carries the same standard inserts as CoroDrill 800.

#### Assortment:

Diameter range: 25.00–65.00 mm  
 Hole depth: 13-7xD  
 Hole tolerance: IT 10  
 Surface finish: <math><Ra 2 \mu m</math> (comparable with CoroDrill 800)

#### Application area:

Work piece materials: ISO P and K (steel and cast iron)  
 Machines: Horizontal machining centres, lathes and multi-task (turn-mill) machines.  
 Coolant: Internal coolant supply.  
 Emulsion, preferably with EP additives, with more than 8% mixture. The same coolant flow and pressure as for an indexable insert short hole drill in corresponding diameter.

# CoroDrill® 805 how to use and order

## Cutting data:

ISO	CMC No.	Material	Specific cutting force $k_c$ 0,4	Hardness Brinell	Geometry/grade			Support pad grade	Cutting speed	Feed, $f_n$ mm/r		
					Insert					$v_c$ m/min	Drill diameter, mm	
					P	I	C				25,00-43,00	43,01-65,00
P	01.1	Unalloyed	Non-hardened 0,1-0,25% C	2000	90-200	G/1025	G/1025	G/1025	P1	70-130	0,11-0,31	0,14-0,34
	01.2		Non-hardened 0,25-0,55% C	2100	125-225	G/1025	G/1025	G/1025	P1	70-130	0,11-0,31	0,14-0,34
	01.3		Non-hardened 0,55-0,80% C	2180	150-250	G/1025	G/1025	G/1025	P1	70-130	0,11-0,31	0,14-0,34
	01.4		High carbon steel, annealed	2320	180-275	G/1025	G/1025	G/1025	P1	70-130	0,11-0,31	0,14-0,34
	02.1	Low alloy	Non-hardened	2100	150-260	G/1025	G/1025	G/1025	P1	70-120	0,11-0,31	0,20-0,34
	02.2		Hardened and tempered	2775	220-450	G/1025	G/1025	G/1025	P1	55-110	0,11-0,31	0,20-0,34
	03.11	High alloy	Annealed	2500	150-250	G/1025	G/1025	G/1025	P1	70-120	0,11-0,31	0,20-0,34
	03.13		Annealed HSS	2750	150-250	G/1025	G/1025	G/1025	P1	70-120	0,11-0,31	0,20-0,34
	03.21		Hardened tool steels	3750	250-350	G/1025	G/1025	G/1025	P1	55-110	0,11-0,29	0,20-0,30
	03.22		Hardened steels, others	4000	250-450	G/1025	G/1025	G/1025	P1	55-110	0,20-0,29	0,20-0,30
06.1	Castings	Unalloyed	1800	90-225	G/1025	G/1025	G/1025	P1	55-110	0,11-0,31	0,20-0,34	
06.2		Low alloyed (alloying elements <5%)	2100	150-250	G/1025	G/1025	G/1025	P1	55-110	0,11-0,31	0,20-0,34	
06.32	Castings	Stainless austenitic	2300	150-250	G/1025	G/1025	G/1025	P1	50-100	0,11-0,25	0,20-0,29	
06.33		Manganese steel 12-14% Mn	3600	200-300	G/1025	G/1025	G/1025	P1	35- 85	0,11-0,25	0,20-0,29	
K	07.1	Malleable	Ferritic	950	110-145	G/1025	G/1025	G/1025	M1	80-120	0,11-0,29	0,24-0,31
	07.2		Pearlitic	1100	150-270	G/1025	G/1025	G/1025	M1	80-120	0,11-0,29	0,24-0,31
	08.1	Grey	Low tensile strength	1100	150-220	G/1025	G/1025	G/1025	M1	60-110	0,11-0,29	0,24-0,31
	08.2		High tensile strength	1290	200-330	G/1025	G/1025	G/1025	M1	60-110	0,11-0,29	0,24-0,31
	09.1	Nodular	Ferritic	1050	125-230	G/1025	G/1025	G/1025	M1	50-110	0,11-0,29	0,24-0,31
	09.2		Pearlitic	1750	200-300	G/1025	G/1025	G/1025	M1	50-110	0,11-0,29	0,24-0,31

## Method:

1. Make a short pilot hole, min 12 mm deep for diameter 25 mm and min 20 mm deep for diameter 65 mm. To achieve a hole with a close tolerance the diameter of the pilot hole should be of H8, which normally can be achieved by helical interpolation with a solid carbide endmill. If it's not critical with hole tolerance the pilot hole can be drilled with the CoroDrill 880 in corresponding diameter.
2. Feed the CoroDrill 805 into the pilot hole with slow rotation and coolant on.
3. Start rpm and feed movement.

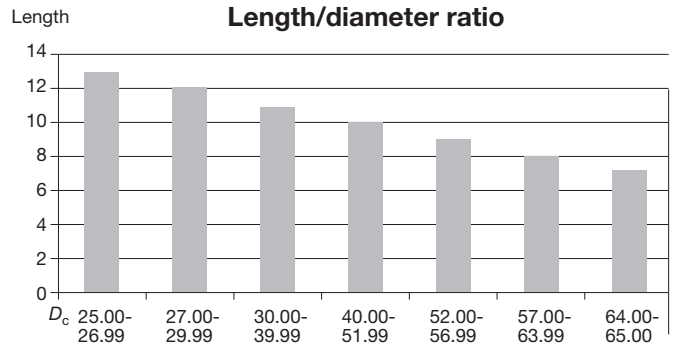

## How to order:

Contact your Sandvik Coromant representative to order the drill body in the required length and diameter.

Inserts (Ordered separately)						Support pads (Ordered separately)	
Intermediate and peripheral inserts are also available in L- geometry (ordering example: 800-05 03 08M-I-L) for long chipping materials see page 80-81 in Deep hole drilling catalogue C-1202:1.							
Diameter range, mm	Central	Diameter range, mm	Intermediate	Diameter range, mm	Peripheral	Diameter range, mm	Pad
25,00-28,70	05 800-05 03 08M-C-G	25,00-31,00	05 800-05 03 08M-I-G	25,00-31,00	06 800-06 03 08H-P-G	25,00-31,00	800-06A
28,71-33,99	06 800-06 T3 08M-C-G	31,01-34,99	06 800-06 T3 08M-I-G	31,01-38,99	08 800-08 T3 08H-P-G	31,01-39,60	800-07A
34,00-43,00	08 800-08 T3 08M-C-G	35,00-54,99	08 800-08 T3 08M-I-G	39,00-49,99	09 800-09 T3 08H-P-G	39,61-47,00	800-08A
43,01-47,00	10 800-10 T3 08M-C-G	55,00-65,00	12 800-12 T3 08M-I-G	50,00-65,00	11 800-11 T3 08H-P-G	47,01-54,99	800-10A
47,01-49,99	12 800-12 T3 08M-C-G					55,00-65,00	800-12A
50,00-57,99	10 800-10 T3 08M-C-G						
58,00-65,00	12 800-12 T3 08M-C-G						

# Gun drill 428.9 and 428.2

Diameter range 0,98 – 40,50 mm

## Easy to use

- No pre-setting
- No need for tool room service

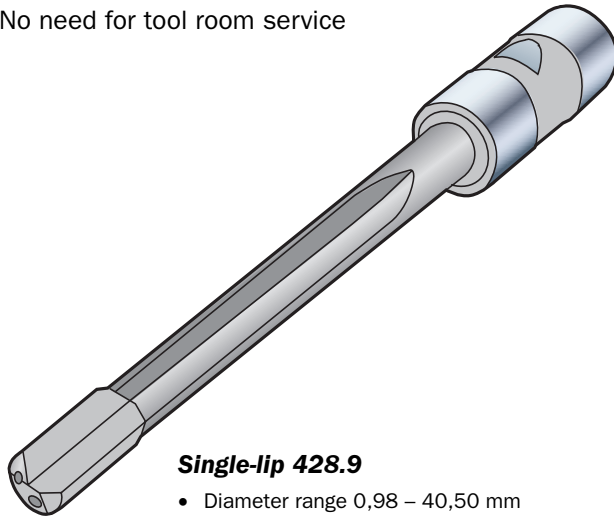

### Single-lip 428.9

- Diameter range 0,98 – 40,50 mm
- The basic choice for drilling of all materials
- Hole tolerance IT9
- Surface finish  $R_a$  0,1 – 3,0  $\mu\text{m}$

## Wide application area

- Optimized grade- and geometry combinations for most workpiece materials
- When ordering state workpiece material to be drilled

## Customer specified diameter

- Finish ground within 0,01 mm increments

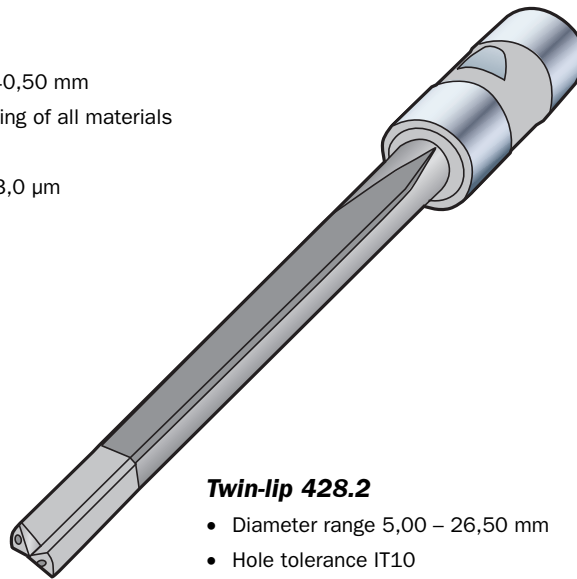

### Twin-lip 428.2

- Diameter range 5,00 – 26,50 mm
- Hole tolerance IT10
- Surface finish  $R_a$  1,0 – 4,0  $\mu\text{m}$
- Suitable for short chipping materials.
- The feed rate can be increased compared to the single lip

## Solid carbide head 428.2 and 428.9

- The first choice for small diameters from 0,98 mm and when extra close diameter tolerance is demanded
- Standard programme



**Gun drills**  
Solid carbide heads 428.9 and 428.2

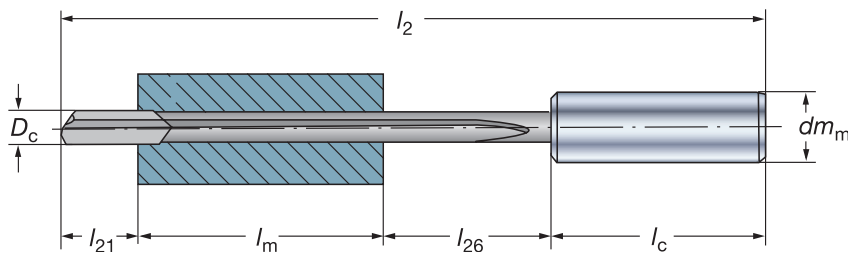

$l_2$  = Overall length with or without driver  
 $D_c$  = Drill diameter  
 $l_{21}$  = Addition for regrinding  
 $l_m$  = Depth of hole  
 $l_{26}$  = Minimum chip evacuation distance  
 $l_c$  = Length of driver  
 $dm_m$  = Driver diameter

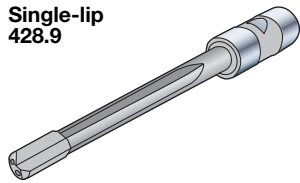

**Single-lip 428.9**

**Drill diameter:** 0,98–40,50 mm  
**Hole depth:**  $\leq 100 \times \text{diameter}$   
**Hole tolerance:** IT9  
**Surface finish:**  $R_a$  0,1–3,0  $\mu\text{m}$   
**Cutting fluid:** Neat oil  
**Tolerance:**  $D_c = h5$   
 $dm_m = d9$

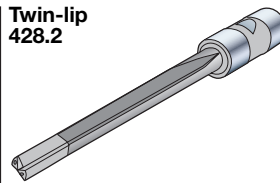

**Twin-lip 428.2**

**Drill diameter:** 5,00–26,50 mm  
**Hole depth:**  $\leq 100 \times \text{diameter}$  (**Note!**  $l_{2 \text{ max}} = 1250 \text{ mm}$ )  
**Hole tolerance:** IT10  
**Surface finish:**  $R_a$  1,0–4,0  $\mu\text{m}$   
**Cutting fluid:** Neat oil  
**Tolerance:**  $D_c = h5$   
 $dm_m = d9$

Diameter range, mm	Ordering code	Dimensions, mm		Diameter range, mm	Ordering code	Dimensions, mm	
		$l_{21}$	$l_{26}$			Suitable only for short chipping materials	$l_{21}$
$D_c$ mm	<b>P M K N S</b>	$l_{21}$	$l_{26}$	$D_c$ mm	<b>P K N</b>	$l_{21}$	$l_{26}$
0,98– 1,84	428.9- xxxxx-AAAA-BBB	8	25	5,00– 7,05	428.2- xxxxx-AAAA-BBB	23	30
1,85– 2,60	xxxxx-AAAA-BBB	10	25	7,06– 8,55	xxxxx-AAAA-BBB	25	40
2,61– 3,35	xxxxx-AAAA-BBB	13	25	8,56–13,05	xxxxx-AAAA-BBB	25	50
3,36– 4,05	xxxxx-AAAA-BBB	13	30	13,06–18,05	xxxxx-AAAA-BBB	25	55
4,06– 5,15	xxxxx-AAAA-BBB	19	30	18,06–23,00	xxxxx-AAAA-BBB	30	65
5,16– 7,05	xxxxx-AAAA-BBB	23	30	23,01–26,50	xxxxx-AAAA-BBB	35	65
7,06– 8,55	xxxxx-AAAA-BBB	25	40				
8,56–13,05	xxxxx-AAAA-BBB	25	50				
13,06–18,05	xxxxx-AAAA-BBB	25	55				
18,06–23,00	xxxxx-AAAA-BBB	30	65				
23,01–26,50	xxxxx-AAAA-BBB	35	65				
26,51–32,00	xxxxx-AAAA-BBB	40	80				
32,01–40,50	xxxxx-AAAA-BBB	45	90				

When ordering gun drills the following must be stated:

- Drill diameter, xxxxx in the ordering code.
- Overall length  $l_2$ , AAAA in the ordering code.
- If required, driver No., BBB in the ordering code.
- Material to be drilled.

For regrinding, see page 145.

**Ordering example for gun drill head  $D_c$  1,90 mm, length 250 mm with driver No 002 for drilling stainless steel:**

**2 pieces 428.9-01900-0250-002 solid carbide head for stainless steel.**

**For further information, please contact your local sales representative.**

**SAFETY INFORMATION**  
Precautions when grinding and brazing of cemented carbide, see page 159.

Driver 111	Oil supply unit 112	Accessories 113	Cutting data $v_c$ 116
---------------	------------------------	--------------------	---------------------------

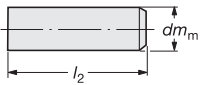
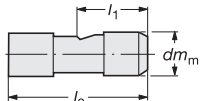
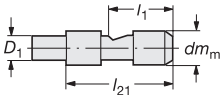
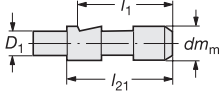
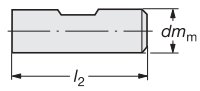
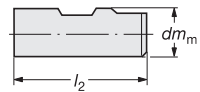
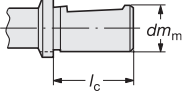
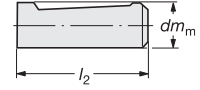
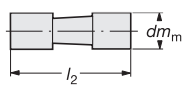
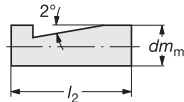
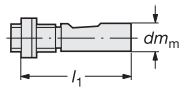
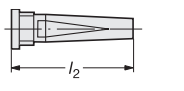
Drivers for gun drills 428.2 and 428.9	Diameter range, mm	Driver <sup>3)</sup>	Dimensions, mm						Shank type	
	$D_c$ mm	No.	$dm_m$	$D_1$	$l_1$	$l_2$	$l_{21}$	$l_c$		
	0,98– 1,94 1,90– 4,50 1,90– 7,30 1,90–12,40 1,90–15,90 6,00–19,50	<b>004</b> <b>006</b> <b>010</b> <b>016</b> <b>020</b> <b>025</b>	4 6 10 16 20 25	– – – – – –	– – – – – –	30 36 40 48 50 56	– – – – – –	– – – – – –	Cylindrical	
	1,90–20,50 1,90–29,60 10,00–48,99 4,00–20,50 6,00–49,00 1,90– 7,30 7,30–19,60	<b>002</b> <b>003</b> <b>005</b> <b>035</b> <b>036</b> <b>601</b> <b>801</b>	16 20 32 19,05 25,40 10 25	– – – – – – –	31 34 34 34 34 24 33,30	45 70 70 70 70 40 70	– – – – – – –	– – – – – – –	– – – – – – –	
	6,55–12,50 19,60–49,00	<b>602</b> <b>802</b> <sup>1)</sup>	10 25	– 8,20 20,30	24 33,30	– –	40 70	– –	– –	
	1,95–12,60 12,60–20,50	<b>701</b> <b>702</b>	16 16	– 13,5	47 47	– –	50 50	– –	– –	
	1,95–12,59 1,95–12,59 1,95–16,59 1,95–20,50	<b>903</b> <b>904</b> <b>905</b> <b>906</b>	10 12 16 20	– – – –	– – – –	40 45 48 50	– – – –	– – – –	Weldon	
	6,00–49,00 9,70–49,00 9,70–49,00	<b>907</b> <b>908</b> <b>909</b>	25 32 40	– – –	– – –	56 60 70	– – –	– – –	Weldon	
	1,95–16,59 1,95–20,50 6,00–26,60 9,70–34,50 9,70–42,70	<b>405</b> <b>406</b> <b>407</b> <b>408</b> <b>409</b>	16 20 25 32 40	– – – – –	– – – – –	– – – – –	– – – – –	40 40 45 45 55	Coromant Whistle Notch	
	1,95– 9,00 1,95–12,59 1,95–16,59 1,95–20,50 6,00–49,00 9,70–49,00	<b>603</b> <b>604</b> <b>605</b> <b>606</b> <b>607</b> <b>608</b>	10 12 16 20 25 32	– – – – – –	– – – – – –	40 45 48 50 56 60	– – – – – –	– – – – – –	Whistle Notch	
	1,95– 9,80 1,95–12,00 3,96–15,20 3,96–29,60	<b>101</b> <b>102</b> <b>103</b> <b>104</b>	12,70 16 19,05 20	– – – –	– – – –	38,10 70 70 70	– – – –	– – – –	– – – –	
	3,96–20,50 6,00–49,00 6,00–49,00 9,70–49,00 9,70–49,00 9,70–49,00	<b>204</b> <b>205</b> <b>206</b> <b>207</b> <b>208</b> <b>209</b>	19,05 25,40 28 31,75 36 38,10	– – – – – –	– – – – – –	70 70 70 70 70 70	– – – – – –	– – – – – –	– – – – – –	
	1,90–12,00 1,90–15,20 6,00–26,00 8,70–32,60 11,90–49,00	<b>301</b> <sup>2)</sup> <b>302</b> <sup>2)</sup> <b>303</b> <sup>2)</sup> <b>304</b> <sup>2)</sup> <b>305</b> <sup>2)</sup>	16 20 28 36 48	– – – – –	112 126 126 162 166	– – – – –	– – – – –	– – – – –	– – – – –	
	1,90– 9,20 9,20–16,10 16,10–23,60 23,40–34,00	<b>501</b> <sup>2)</sup> <b>503</b> <sup>2)</sup> <b>504</b> <sup>2)</sup> <b>505</b> <sup>2)</sup>	– – – –	– – – –	– – – –	84 84 131 200	– – – –	– – – –	Morse taper Morse taper Morse taper Morse taper	1 3 4 4

1) Supplied with driving dog.  
2) Adjustable.  
3) Available on request.



## CoroGrip® heavy duty power chuck

CoroGrip is the best choice of holder when using gundrills in machining centre applications with coolant through the spindle.

CoroGrip power chuck combines security and versatility in a sturdy new construction. Maximum clamping strength and maximum rigidity, and all chucks are individually balanced for maximum security at high rotational speeds.

For ordering information, see latest Rotating tools catalogue.

For CoroGrip holders we recommended gundrills with cylindrical drivers.

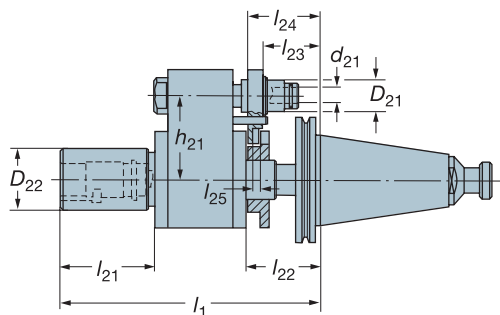

**Automatic toolchange oil supply unit**  
Diameter range: 1,85 – 25,00 mm

Diameter range, mm	Driver	Shank	Max rev	Max pressure	Dimensions, mm
$D_c$ mm	$dm_m$ mm	ISO taper	RPM	MPa	$D_{21}$ $D_{22}$ $d_{21}$ $h_{21}$ $l_1$ $l_{21}$ $l_{22}$ $l_{23}$ $l_{24}$ $l_{25}$
1,85–25	10–25	40/50	10000	10	24 48 12 65 204,8 75 58,2 45 57 6

For ordering an automatic toolchange oil supply unit, please contact your nearest Sandvik representative.

**Oil supply unit**  
Diameter range: 1,85 – 40,05 mm

Diameter range, mm	Driver	Oil supply unit size <sup>1)</sup>	Shank	Max rev	Max pressure	Dimensions, mm
$D_c$ mm	$dm_m$ mm		Morse taper	RPM	MPa	$D_{21}$ $D_{22}$ $l_1$ $l_2$ $l_{21}$ $l_{22}$ $Th$
1,85–25	10–28	1	3	10000	10	75 48 152 233 75 72 M12
25,01–40,05	28–38,1	2	4	4000	5	95 60 165 270 75 84 M14

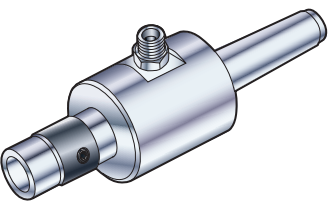
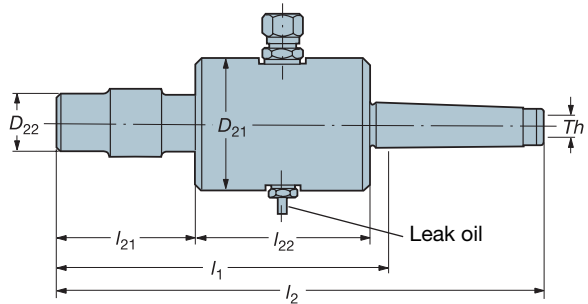
<sup>1)</sup> Oil supply units for drivers no. 002, 801, 802, are stocked items. Oil supply units for other drivers on request.

Ordering example: 1 piece Oil supply unit, size 1, with driver xxx

For further information, please contact your local sales representative.

### Accessories

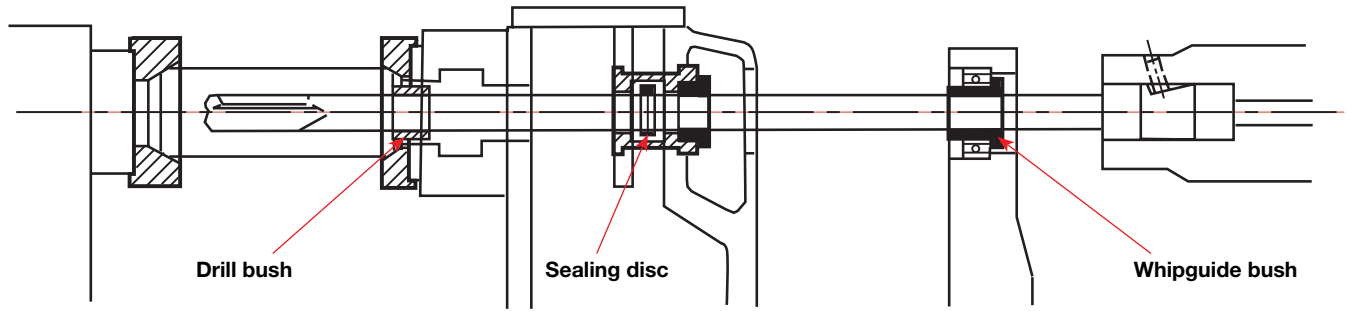

#### Drill bush

According to DIN 179 extended model made of tool steel, hardened throughout.  
Give measurement  $D_c$  when placing an order.

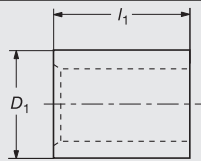

$D_c$ mm	$D_1$	$l_1$
0,8– 1,099	3	9
1,1– 1,899	4	9
1,9– 2,699	5	9
2,7– 3,399	6	12
3,4– 4,099	7	12
4,1– 5,099	8	12
5,1– 6,099	10	16
6,1– 8,099	12	16
8,1–10,099	15	20
10,1–12,099	18	20
12,1–15,099	22	28
15,1–18,099	26	28
18,1–22,099	30	36
22,1–26,099	35	36
26,1–30,099	42	45
30,1–35,099	48	45
35,1–42,099	55	56

#### Sealing disc<sup>1)</sup>

Made of special plastic  
Give drill diameter  $D_c$  when placing an order.

#### Single-Lip

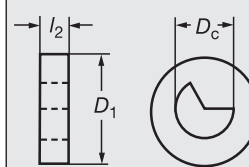

#### Twin-Lip

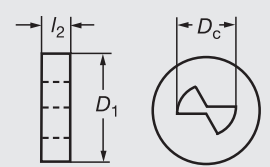

#### Diameter range, mm

$D_c$ mm	$D_1$	$l_2$
2,0– 6,2	20	3
6,3–18,5	32	4
18,6–24,6	40	4
24,7–42,0	90	4

<sup>1)</sup> The sealing disc fits tightly onto the drill shank and must be held in position in the chip box with a retaining device. This prevents the disc moving with the feed motion, which could cause chip obstruction.

#### Whipguide bush

Made of special plastic  
Give drill diameter  $D_c$  when placing an order.

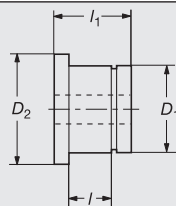

#### Diameter range, mm

$D_c$ mm	$D_1$	$D_2$	$l$	$l_1$
2,0–12,0	20	26	12	22
2,0–25,0	30	38	16	26
2,0–37,0	45	52	14	26

For further information, please contact your local sales representative.

## Cutting data for gun drills 428.9 and 428.2

ISO	CMC No.	Material		Specific cutting force $k_c$ 0,4 N/mm <sup>2</sup>	Hardness Brinell HB	Cutting speed $v_c$ m/min	Drill diameter, mm				
							0,98-3,00	3,00-6,30	6,00-12,50	12,50-40,50	
							1) Feed, $f_n$ mm/r				
<b>P</b>    <b>Steel</b>	01.1 01.2 01.3	Unalloyed	Non-hardened 0,1-0,25% C	2000	90-200	60-120	0,003-0,010	0,005-0,030	0,015-0,055	0,020-0,110	
			Non-hardened 0,25-0,55% C	2100	125-225	50-120	0,003-0,010	0,005-0,030	0,015-0,055	0,020-0,110	
			Non-hardened 0,55-0,80% C	2180	150-250	40-100	0,003-0,010	0,004-0,025	0,010-0,050	0,020-0,100	
	02.1 02.2	Low alloy	Non-hardened	2100	150-260	40-120	0,003-0,010	0,004-0,030	0,010-0,055	0,020-0,110	
			Hardened and tempered	2775	220-450	40-120	0,003-0,010	0,004-0,025	0,010-0,050	0,020-0,100	
03.11 03.21	High alloy	Annealed	2500	150-250	40-100	0,003-0,010	0,004-0,025	0,010-0,050	0,020-0,100		
		Hardened tool steels	3750	250-350	50-100	0,003-0,010	0,005-0,025	0,015-0,050	0,030-0,100		
06.1 06.2	Castings	Unalloyed	1800	90-225	50-120	0,003-0,010	0,005-0,030	0,015-0,055	0,020-0,110		
		Low alloyed (alloying elements <5%)	2100	150-250	40-100	0,003-0,010	0,004-0,025	0,010-0,050	0,020-0,100		
<b>M</b>  <b>Stainless steel</b>	05.11	Rolled/forged	Ferritic, martensitic Non-hardened	2300	150-270	40- 90	0,003-0,008	0,004-0,025	0,010-0,040	0,020-0,100	
	05.21		Austenitic	2600	150-275	40- 90	0,003-0,008	0,004-0,025	0,010-0,040	0,020-0,100	
<b>K</b>  <b>Cast iron</b>	07.1 07.2	Malleable	Ferritic	950	110-145	70- 90	0,005-0,010	0,008-0,030	0,020-0,070	0,050-0,190	
			Pearlitic	1100	150-270	60- 90	0,004-0,010	0,005-0,030	0,010-0,070	0,030-0,190	
	08.1 08.2	Grey	Low tensile strength	1100	150-220	60- 90	0,004-0,010	0,005-0,030	0,010-0,070	0,030-0,190	
	High tensile strength		1290	200-330	15- 90	0,003-0,010	0,003-0,030	0,005-0,070	0,010-0,190		
09.1 09.2	Nodular	Ferritic	1050	125-230	70- 90	0,005-0,010	0,008-0,030	0,020-0,070	0,050-0,190		
		Pearlitic	1750	200-300	60- 90	0,004-0,010	0,005-0,030	0,010-0,070	0,030-0,190		
<b>N</b>  <b>Non-ferrous metals</b>	30.21	Aluminium alloys	Cast, non-aluminum	750	40-100	65-300	0,005-0,015	0,005-0,040	0,020-0,070	0,030-0,150	
	33.1 33.2		Copper and copper alloys	Free cutting alloys Pb >1%	700	70-160	65-300	0,005-0,015	0,005-0,040	0,020-0,070	0,030-0,150
				Brass and leaded bronzes Pb ≤1%	700	50-200	65-300	0,005-0,015	0,005-0,040	0,020-0,070	0,030-0,150
<b>S</b>  <b>Heat resistant super alloys</b>	20.11	Iron base	Annealed or solution treated	3000	180-230	10- 40	0,003-0,008	0,004-0,025	0,010-0,040	0,020-0,100	
	20.21		Nickel base	Annealed or solution treated	3320	140-300	10- 40	0,003-0,008	0,004-0,025	0,010-0,040	0,020-0,100
	20.31		Cobalt base	Annealed or solution treated	3300	180-230	10- 40	0,003-0,008	0,004-0,025	0,010-0,040	0,020-0,100
	23.21	Titanium	Alfa, near alfa and alfa + beta alloys annealed	1675	Rm <sup>9</sup> 600-1100	20- 50	0,003-0,008	0,004-0,025	0,010-0,040	0,020-0,100	

Graphs see page 117.

**P** Cutting data for Twin-lip gun drills 428.2Suitable only for short chipping materials, use same cutting speed ( $v_c$ ) as for 428.9 and increase feed ( $f_n$ ) with 30-50%.**K****N**

Graphs for gun drills 428.9 and 428.2

**Net power**

$P_c$  kW

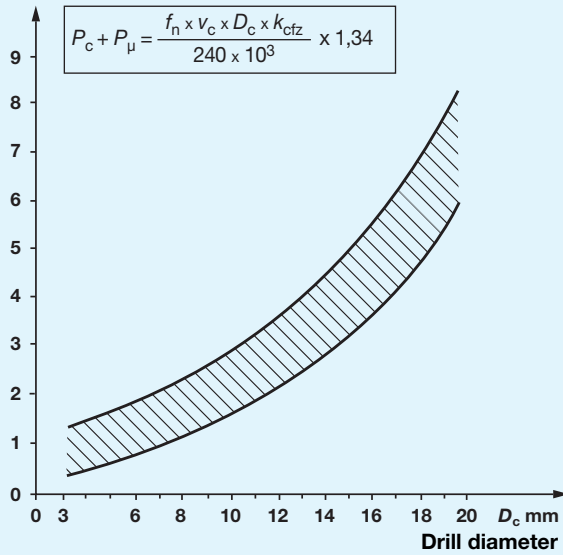

**Straightness**

Hole straightness depends on various factors e.g.

- Hole diameter and depth
- Machining method and cutting parameters
- Material quality and homogeneity
- Machine condition
- Drill bush

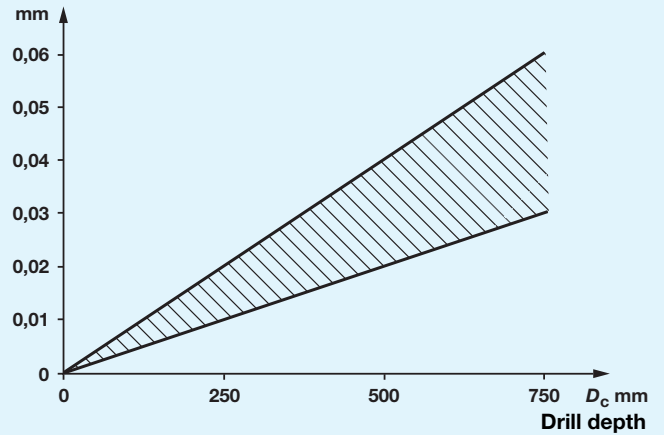

**Cutting fluid flow**

$q$  l/min

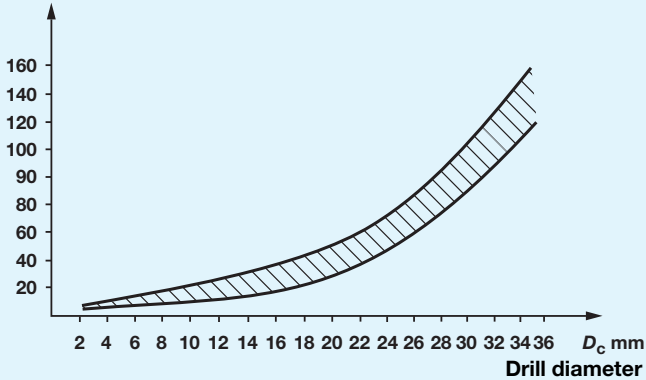

**Cutting fluid pressure**

$P$  MPa

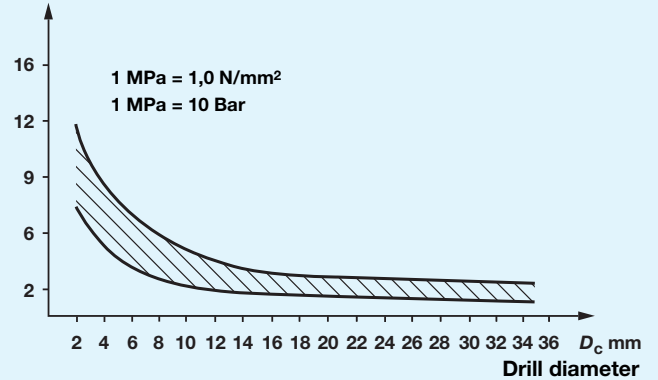

**Terminology and units**

$D_c$	Drill diameter	mm	$F_f$	Feed force	N
$a_p$	Cutting depth	mm	$F_\mu$	Feed force caused by friction	N
$v_c$	Cutting speed	m/min	$M_c$	Torque	Nm
$n$	Spindle speed	r/min	$M_\mu$	Torque caused by friction	Nm
$v_f$	Feed speed	mm/min	$P_c$	Net power	kW
$f_n$	Feed per rev.	mm/r	$P_\mu$	Power caused by friction	kW
$Q$	Material removal rate	cm <sup>3</sup> /min	$\kappa_r$	Cutting edge angle	Degrees
$k_c$	Specific cutting force	N/mm <sup>2</sup>	$q$	Cutting fluid quantity	l/min
$k_{c0,4}$	Specific cutting force for $f_z = 0,4$	N/mm <sup>2</sup>	$p$	Cutting fluid pressure	Mpa

The graphs show nominal values which should not be regarded as strict recommendations. The values may need adjusting depending on the machining conditions e.g., the type of material.

Note that only net power ratings are given. Allowance must be made for the efficiency of the machine and the cutting edge wear.



A series of horizontal dotted lines spanning the width of the page, intended for writing or drawing.

# **DEEP HOLE DRILLING**

## **Application guide**

Drilling system and methods	<b>120–123</b>
Hole quality	<b>124</b>
Centre alignment	<b>125</b>
Special application cases	<b>126</b>
Cutting fluid	<b>127–129</b>
The Ejector system	<b>130–133</b>
The Single Tube System – STS	<b>134–135</b>
Drill bush and set up	<b>136–137</b>
Machining recommendations	<b>138–139</b>
Choice of cutting data	<b>140–141</b>
The gun drill system	<b>142–143</b>
Gundrilling in machining centres	<b>144</b>
Gundrill – regrinding equipment	<b>145</b>
Regrinding single-lip/twin-lip gundrills	<b>146–147</b>
Balanced and unbalanced drills	<b>148</b>
Cutting data calculations	<b>149</b>
Cutting forces	<b>150</b>
Trouble shooting	<b>151–152</b>
Material cross reference list	<b>153–157</b>
Insert mounting	<b>158</b>
Safety information	<b>159</b>

## Deep hole drilling

Common examples of deep hole drilling are characterized by high material removal rate plus high accuracy with regard to the straightness of the hole, dimensional tolerances and surface finish. The extreme conditions which apply when drilling deep holes place high demands on the tool, machine and associated equipment.

Deep hole drilling applications are found within a wide range of industries, such as steel, nuclear power, aerospace, oil and gas. Here, high demands are placed on quality as well as dimension and shape tolerances.



Workpieces can be very expensive and rejections can, more or less, result in economic consequences. Reliability during the operation is therefore usually given high priority. All in all this means that the tools and drilling systems which are developed to satisfy these requirements offer qualities which, in certain applications, are desirable even when drilling short holes.



## Deep hole drilling with Sandvik Coromant

Deep holes are defined by a high ratio between hole depth and hole diameter.

Deep-hole drilling is the preferred method for drilling hole depths of more than 10 x the diameter. During drilling, it is important that the chips are broken and that they can be transported away without jamming and affecting the drilled surface.

In deep-hole drilling, cutting fluid supply and chip transport have been provided for the development of three different systems that permit trouble-free machining of hole depths of more than 100 x the diameter.

- **Ejector system (two-tube system)**
- **Single Tube System (STS)**
- **Gun drilling system**

Sandvik Coromant are a world leading manufacturer of deep hole machining tools for these systems.

The tools are available as standard, special or TailorMade and there is an excellent world wide delivery -and service facility.

### The Ejector system

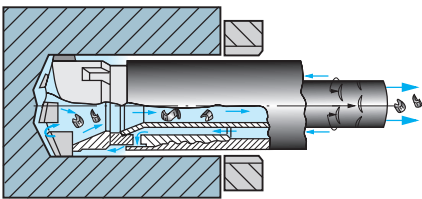

### The STS system

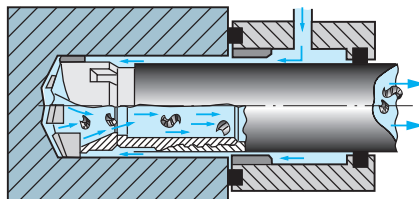

### The Gun drilling system

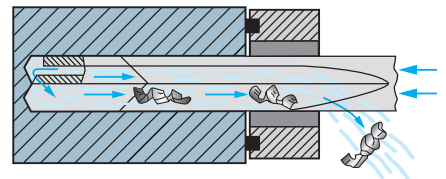

## When to choose Ejector and STS systems

### Ejector system:

- Requires no seal between the workpiece and the drill bushing.
- Adapted easily to existing machines, preferable in conventional lathes, turning centres, machining centres and horizontal boring machines.
- For machining workpieces where sealing problems can arise.
- An advantage when it is possible to use a pre-drilled hole instead of a drill bushing for guidance, for example in machining centres.

### STS system:

- In materials with poor chip forming properties such as stainless steel, and low-carbon steel.
- In materials with an uneven structure when chipbreaking problems exist.
- More advantageous for long series production.
- Uniform and extremely long work pieces.
- For hole diameters larger than 200 mm.
- Requires special deep hole drilling machine.

### Gun drill system:

- For small diameters.
- Can easily be applied to machining centres by using a pre-drilled hole for guidance.
- Note: requires high coolant pressure.

## Tool overview

A wide variety of tools is available both regarding types of drills and diameter ranges. Today's programme covers from 0,98 to 278,99. Dimensions above that available on customer request.

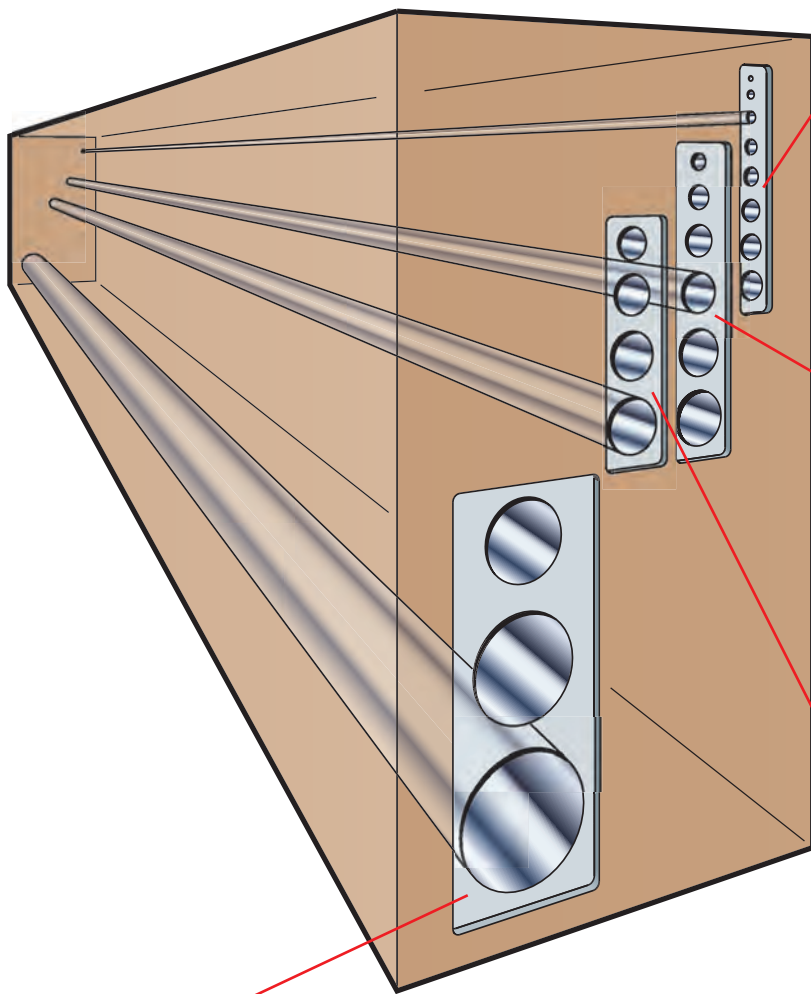

### Gun drill

Diameter range 0,98–40,50 mm  
100 x  $D_c$

#### Productivity



IT9  
Ra 0,1–3,20  $\mu\text{m}$

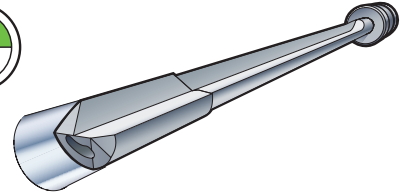

### Brazed drill head

#### Ejector 424.6

Diameter range  
18,40–65,00 mm  
100 x  $D_c$

#### STS 420.6

Diameter range  
15,60–65,00 mm  
150 x  $D_c$

#### Productivity



IT9  
Ra 2  $\mu\text{m}$

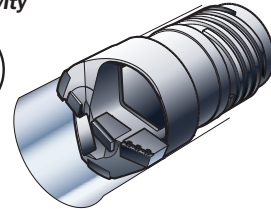

### CoroDrill®

#### Ejector 800.24

Diameter range  
25,00–65,00 mm  
100 x  $D_c$

#### STS 800.20

Diameter range  
25,00–65,00 mm  
150 x  $D_c$

#### Productivity



IT10  
Ra 2  $\mu\text{m}$

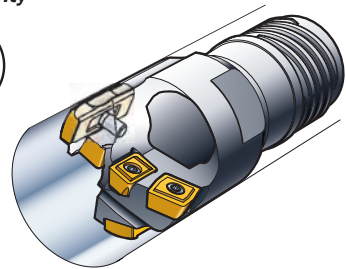

### T-MAX® head

#### Ejector 424.10

Diameter range  
63,50–130,00 mm  
100 x  $D_c$

#### STS 424.10

Diameter range  
63,50–130,00 mm  
150 x  $D_c$

#### Productivity



IT10  
Ra 3  $\mu\text{m}$

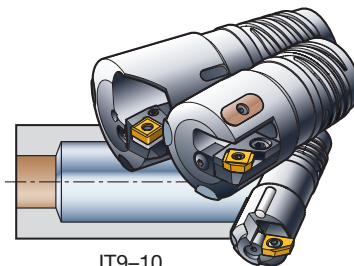
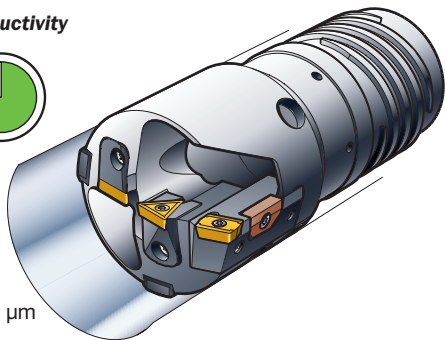

IT9–10  
Ra 1  $\mu\text{m}$

### Counterboring heads T-MAX®

#### Ejector 424.31F

Diameter range  
20,00–124,00 mm  
100 x  $D_c$

#### STS 424.31F

Diameter range  
20,00–124,00 mm  
150 x  $D_c$

#### 424.31

Diameter range  
65,00–183,90 mm  
100 x  $D_c$

#### 424.31

Diameter range  
65,00–278,99 mm  
150 x  $D_c$

T-Max heads outside the standard range can be quoted as Tailor Made or as specials. For specific details regarding the options, contact your Coromant sales representative.

## Deep hole machining methods

### Solid drilling

Solid drilling is the most common method. It involves the machining of a hole in solid material.

Often, the hole diameter, straightness and surface finish are so good that no subsequent machining is required.

### Solid drilling

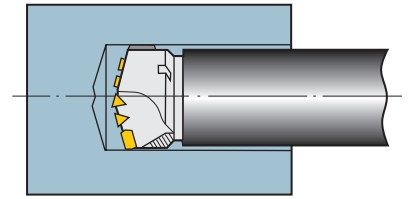

### Counterboring

Counterboring a pre-drilled hole is normally used to obtain better surface finish and tolerances when machining forged, cast, pressed or extruded components.

If the machine power is insufficient for solid drilling in one operation, the hole can be pre-drilled with a smaller solid drill and then counter-bored to the desired diameter.

Hardening, tempering, stress relief annealing or other operations are sometimes performed between solid drilling and counterboring.

### Counterboring

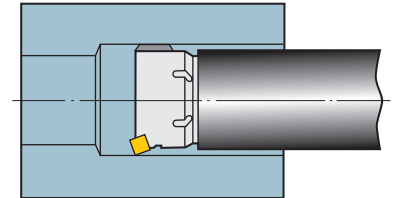

### Trepanning

Trepanning is performed without pre-drilling, but instead of machining away all the material in the form of chips, the tool leaves a solid core in the middle of the hole. This method is chiefly used when machine power is limited, since the power requirement is lower than in solid drilling. In the case of large and expensive workpieces, it may be difficult to obtain suitable sample material. The core can then be used for tensile test specimens and material analysis.

Particularly in the case of expensive material, the core should be recovered and used for other purposes.

#### Note:

In the drilling of blind holes, a special tool is needed to crop off the core.

In deep holes, the core will deflect because of its own weight and must be supported to prevent problems with insert breakages.

### Trepanning

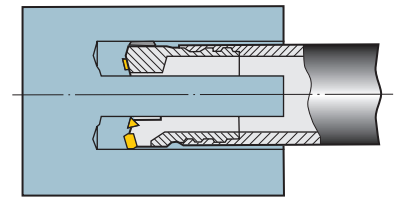

### Cross hole drilling

Cross hole drilling is used in many different applications, e.g. when drilling mould bases regarding coolant holes and channels for the medium.

Another application is drilling pneumatic and hydraulic components.

The operation can be performed by gundrilling or STS.

### Cross hole drilling

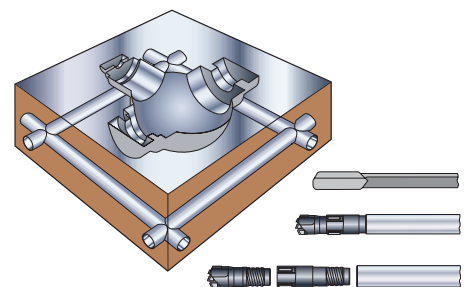

Adapter for cross hole drilling

## Factors affecting hole straightness

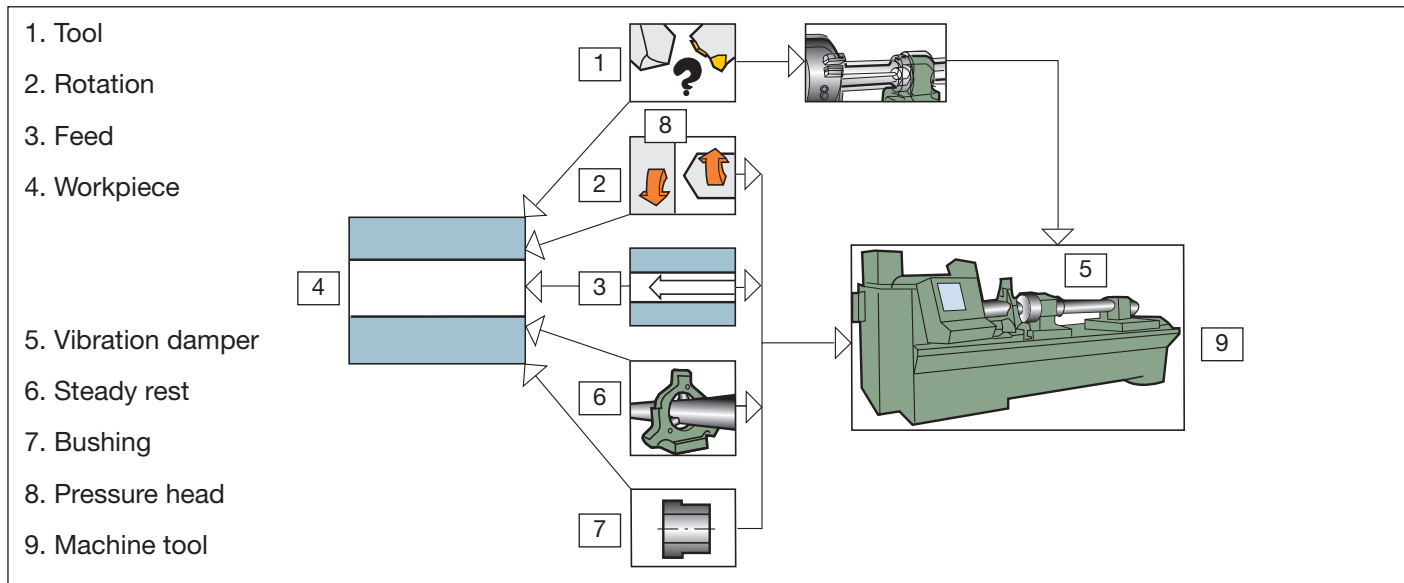

## Hole – straightness affected by workpiece/drill rotation

Hole depths of 50/100 x diameter can be drilled by the Ejector method and 100 x diameter by STS. The following hole depths can be achieved by gun drilling:

- Non-rotating drill without support: 50–80 x diameter
- Rotating drill without support: 30–40 x diameter

With several supports for the drill tube, these values can be exceeded in the hole.

The factors which affect the roundness of the hole are generally the same as in short hole drilling.

The straightness of the hole is more critical due to the depth of the hole.

Worn or incorrectly positioned drill bushings affect the straightness of the hole in a negative way.

With deep holes, where great emphasis is placed on straightness, additional steady rests can improve the results considerably.

The straightness of the hole should not be confused with radial offset between its inlet and its outlet.

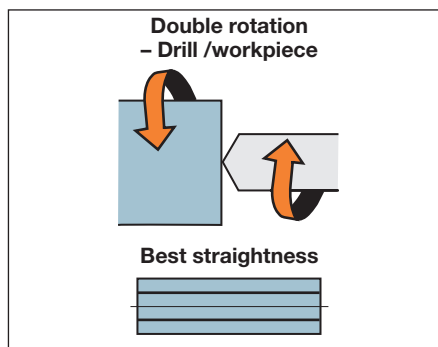

- The best straightness is obtained with counter rotation, i.e. both the drill and the workpiece rotate opposite directions to each other.

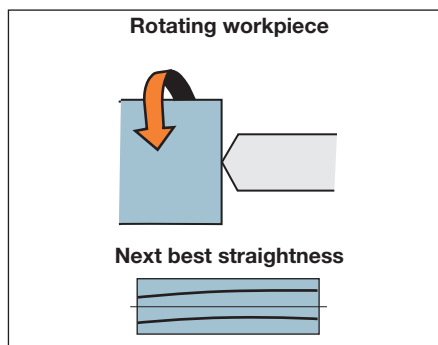

- The next best straightness is obtained with a rotating workpiece. For a non-rotating drill, the deviation of the hole's straightness is usually expressed in simplified terms as 0,1-0,3 mm/ metre of drilled length.

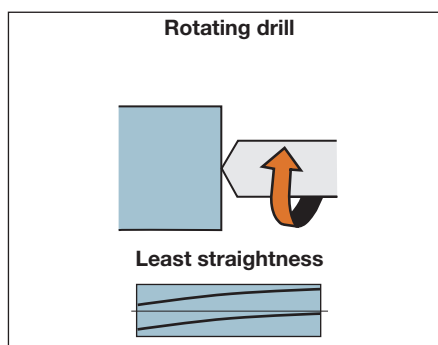

- The least straightness is obtained with a rotating tool. With a rotating drill, relatively good straightness is obtained for short holes, but is greatly reduced for long holes due to deflection of the drill tube. For a rotating drill, a deviation of 0,3–1,0 mm/metre of drilled length is an approximate guide.

## Centre alignment

Due to the large ratio of hole depth to hole diameter, plus the accuracy which is required, the drill will need to be supported during the actual machining process. Therefore, deep hole drilling support pads are used, not only to balance the cutting forces but also to guide the drill against the surface of the drilled hole.

The drill starts in a drill bushing, the task of which is to guide and support the drill from initial penetration until the support pads bear against the drilled surface.

The drilling of deep holes should preferably not start or finish in inclined surfaces. The Ejector system can be used if inclined initial penetration is necessary and then the design of the drill bushing should correspond with the inclination of the workpiece. In addition, an extra support pad is recommended with inclined penetration and also when crossing holes.

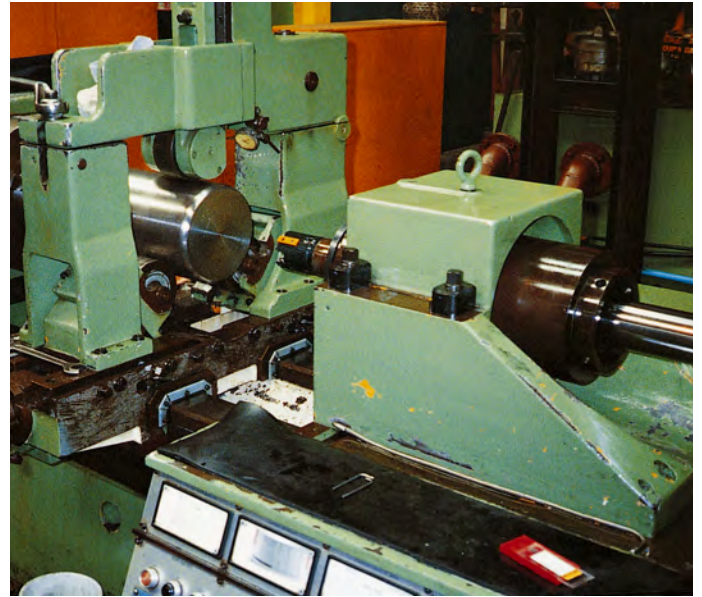

## Set up recommendation

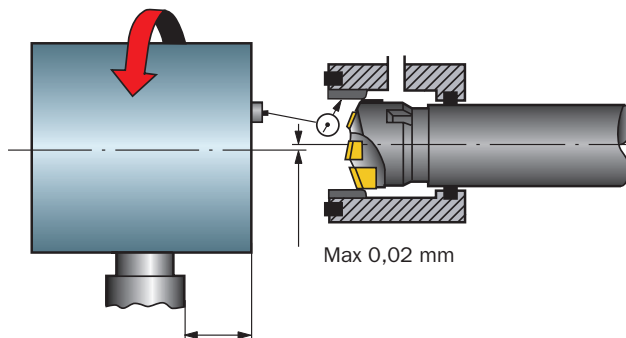

Minimize this distance for best alignment and stability

## Vibration

Vibrations can affect the surface finish and hole quality.

To eliminate vibrations a vibration damper can be applied, see also page 135. Order information page 76.

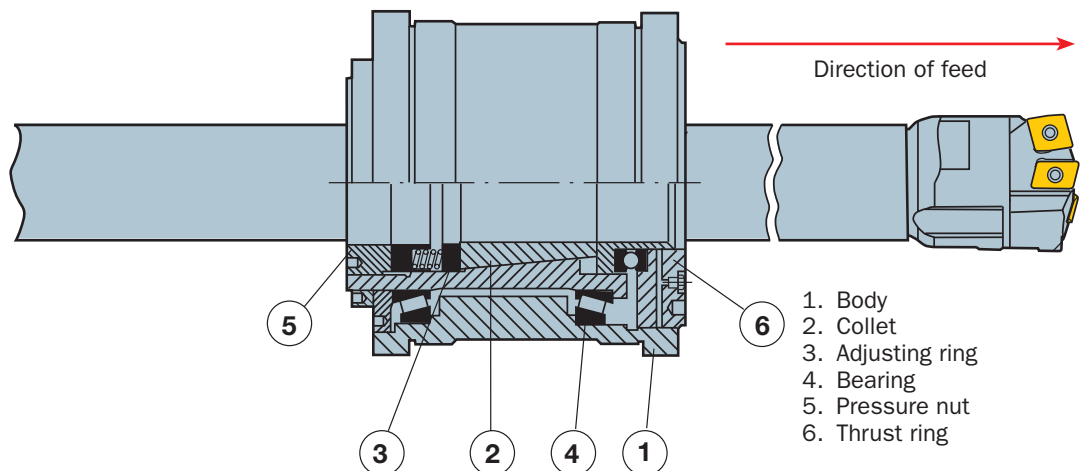



## Tool design – hole straightness

In specific cases such as inclined penetration, cross holes or when counterboring large diameters with long drilling depth, additional pads can be employed. In the later case additional pads aids the straightness by balancing the weight of the of the drill head and tubing. When counterboring with a small  $a_p$  (radial cut depth) additional pads also improves straightness.

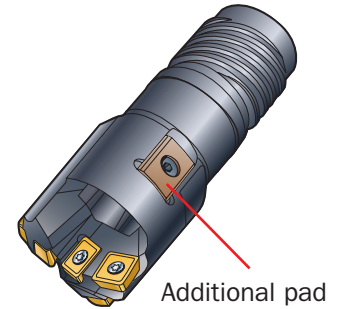

## Workpiece configuration

When drilling a hole close to the edge of the workpiece the effect of the heat produced gives a deviation towards the thinner wall. By clamping another piece of material to the thinner wall side this application can be controlled.

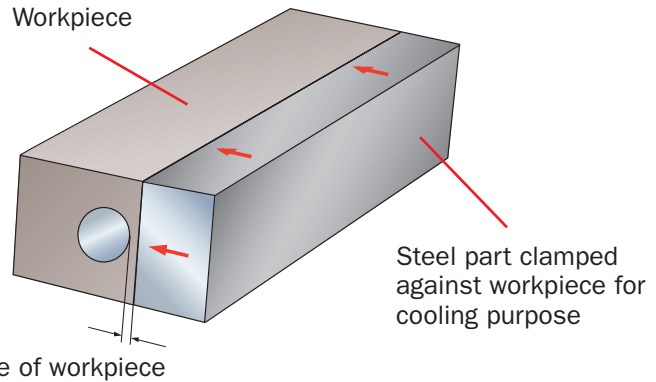

## Tail stock hole

A conventional tail stock hole can create problems when entering the workpiece.

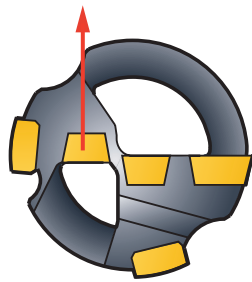
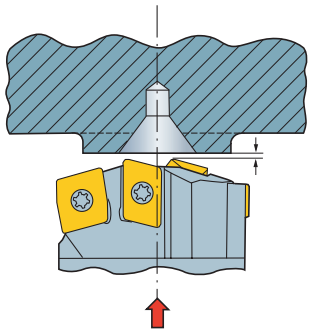

Intermediate insert enters workpiece first instead of central insert which will make the drill move in wrong direction were no support pad is located.

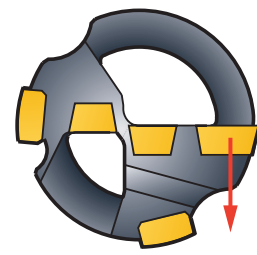
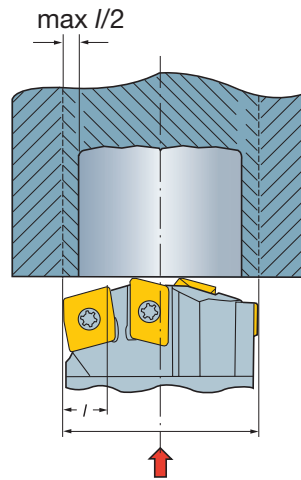

By using a larger prebored hole the peripheral insert enters first and creates a cutting force in the right direction. The drill will work as a counterbore.

## Overlapping holes

If two holes overlapping each other has to be drilled the second hole can be drilled by plugging the first hole.

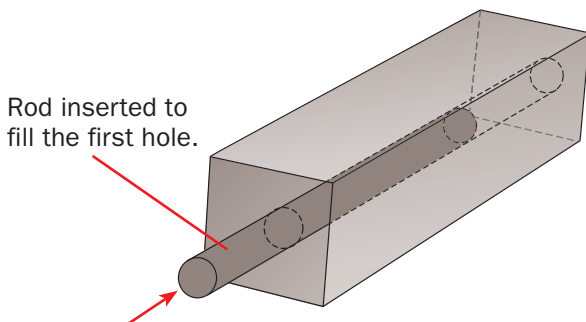

Second hole can be drilled without interrupted cut.

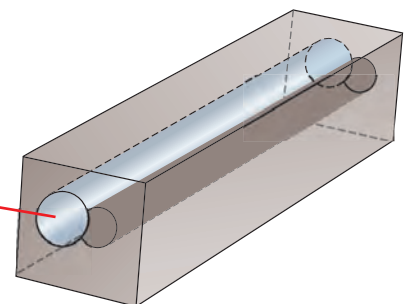
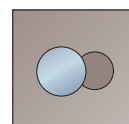

## Example on coolant system

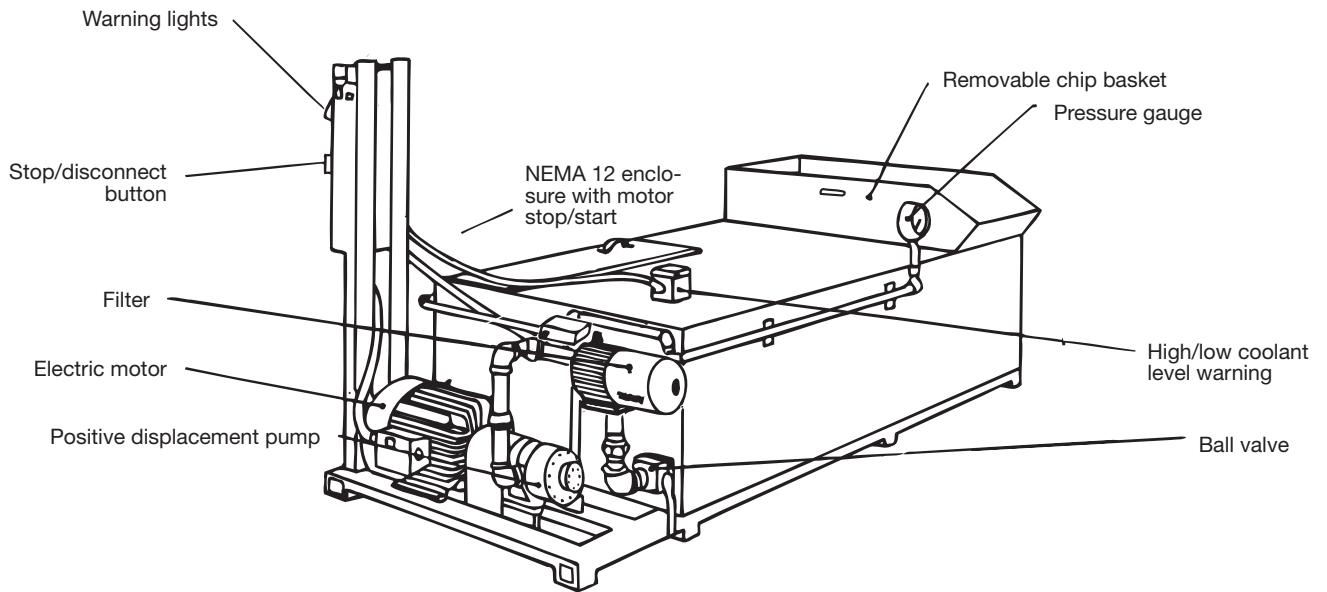

## Coolant system

The purposes of coolant in a drilling system are:

- support and lubrication of the pads
- improvement of the tool life
- dissipation of heat
- chip evacuation

The coolant system has to provide an adequate supply of clean coolant to the tool at the correct pressure and temperature. Many materials can be drilled using the Ejector system with a soluble oil which should contain EP additives (EP = Extreme Pressure). Information can be obtained from your nearest Sandvik office.

### High pressure pump

The two basic parameters are pressure and quantity. Different types of coolant pumps such as gear or screw pumps may be used in the Single Tube System, and for larger coolant requirements, two or more pumps could be connected to a manifold to obtain sufficient supply. To avoid excessive wear, it is important that for a specific coolant, the pumps are equipped with the correct seals. Furthermore, when using soluble emulsion, it is important to ensure that the solution contains sufficient additives to give the necessary lubrication.

### Cutting fluid

The quality of a hole drilled by means of a tool with support pads, such as STS and Ejector drill, depends partly on the quality of the cutting fluid. There are special cutting oils on the market for deep hole drilling methods, which incorporate EP (Extreme Pressure) additives for extreme temperatures at the cutting edge and extreme pressure at the support pads. If a soluble emulsion is chosen, the dilution should be at least 1:10.

### Filtration of cutting fluid

There are two important considerations for good filtration of the cutting fluid. First, the required surface of the drilled hole and the excessive wear characteristics of the support pad. Second, prevent the high pressure pump from wear or even damage. Band filters, sleeve case filters, automatic filters, and magnetic filters are the most common types used. Adequate coolant filtration, down to 10–20  $\mu\text{m}$  increases tool-life

### Reservoir – tank volume

The reservoir capacity should be approximately ten times the highest pump delivery per minute to allow for settling dirt and heat dissipation. In many cases, the tank has a sleeve-type chip container above the compartment for dirty coolant. The compartment for the clean coolant has baffles to allow any air to escape from the coolant.

### Heat exchanger

Almost all the energy put into chip formation, plus a good deal of the power exerted by the pump, is converted into heat which is absorbed by the cutting fluid. When the temperature of the cutting fluid exceeds 55° C, the tool and the pump do not receive correct lubrication and the coolant ages extremely quickly. The best results are achieved with a temperature of 30-40°-C. A large reservoir can provide sufficient cooling effect of the air circulation within the plant. In continuous production, however, it is recommended to use a refrigerated or water-operated heat exchange.



**Tank volume – cooling power**

The volume of the tank should be sufficient to provide effective filtration and cooling. Ordinarily a filter is necessary to separate chips and small particles from the cutting fluid. Normally, the cutting fluid tank should be 10 times the capacity of the pump. The dwell time in the tank should be 5–10 minutes for effective cooling.

As already mentioned, the temperature of the cutting fluid should lie in the range of 30–40°C. The factors that have a heating versus a cooling effect in connection with deep hole drilling are given in the tables.

**The tank is heated by:**

- Drilling energy, which is generated only during the drill's cutting time. Since this is the largest heat source, the cutting time is completely decisive for heating of the tank.
- Pumping energy. All of the pumping energy is converted to heat, 95% of which is absorbed by the cutting fluid.

**The tank is cooled by:**

- The tank giving off heat as soon as the temperature of the cutting fluid is higher than that of the surroundings. If the tank is enclosed, heat loss is greatly reduced.
- The workpiece is generally at ambient temperature and has a cooling effect. In the tables, this cooling effect is calculated for a workpiece with the following dimensions:  
Outside diameter = 2 x hole diameter Length = 20 x hole diameter.

**Max cutting time without extra cooling:**

The following formulas can be used to calculate the time T it takes to raise the temperature of the tank from 20° C to 50° C:

Oil:  $T = \frac{14,25 \times V}{P}$  hours

Water:  $T = \frac{33,8 \times V}{P}$  hours

where V is the tank volume in m<sup>3</sup> and P is the resultant heating effect in kW.

**Example:**

Solid drilling by means of the Ejector system to a hole diameter of 100 mm. The actual cutting time is estimated at 50%. The tank volume is 8 m<sup>3</sup>.

Heating power, total	16 kW
– Cooling power, total	6
Surplus heat to be cooled away	10 kW

When oil is used, it takes

$$T = \frac{14.25 \times V}{P} = \frac{14.25 \times 8}{10} = 11 \text{ hours}$$

to heat up a tank to 50° C. This means that no extra cooling is required with single-shift operation.

Drill diameter D <sub>c</sub> mm	Heating power kW			Cooling power kW			Surplus heat kW			
	Drill	Pump	Total	Work-piece	Tank, m <sup>3</sup>			Tank, m <sup>3</sup>		
					1	8	30	1	8	30
<b>STS-drilling</b>										
20	6	9	15	1	2	7	16	12	7	–
30	9	10	19	1	2	7	16	16	11	2
40	12	12	24	2	2	7	16	20	15	6
60	18	15	33	3	2	7	16	28	23	14
70	21	17	38	3	2	7	16	33	28	19
100	30	20	50	5	2	7	16	43	38	29
120	36	20	56	5	2	7	16	49	44	35
150	45	20	65	7	2	7	16	56	51	42
200	60	20	80	9	2	7	16	69	64	55
250	65	20	95	12	2	7	16	81	76	67
300	90	20	110	13	2	7	16	95	90	81
400	120	20	130	18	2	7	16	110	105	96
<b>Ejector drilling</b>										
20	6	2	8	1	2	7	16	5	–	–
30	9	2	11	1	2	7	16	8	3	–
40	12	3	15	2	2	7	16	11	6	–
60	18	4	22	3	2	7	16	17	12	3
70	21	4	25	3	2	7	16	20	15	6
100	30	5	35	5	2	7	16	28	23	14
120	36	5	41	5	2	7	16	34	29	20
150	45	6	51	7	2	7	16	42	37	28
200	60	7	67	9	2	7	16	56	51	42
250	75	9	81	12	2	7	16	67	62	53
<b>Trepanning</b>										
120	35	20	55	5	2	7	16	48	43	34
150	37	20	57	7	2	7	16	48	43	34
200	47	20	67	9	2	7	16	56	51	42
250	50	20	70	12	2	7	16	56	51	42
300	52	20	72	13	2	7	16	57	52	43
400	54	20	74	18	2	7	16	54	40	40

Heating and cooling factors at 100% cutting time. The cooling effects are calculated at a tank temperature of 50° C.

Drill diameter D <sub>c</sub> mm	Heating power kW			Cooling power kW			Surplus heat kW		
	Tank, m <sup>3</sup>	Tank, m <sup>3</sup>	Tank, m <sup>3</sup>	Tank, m <sup>3</sup>	Tank, m <sup>3</sup>	Tank, m <sup>3</sup>	Tank, m <sup>3</sup>	Tank, m <sup>3</sup>	Tank, m <sup>3</sup>
<b>STS-drilling</b>									
20	7	2	6	12	5	1	–	–	–
30	9	2	6	12	7	3	–	–	–
40	11	2	6	12	9	5	–	–	–
60	15	2	6	12	13	9	3	–	–
70	18	2	6	12	16	12	6	–	–
100	23	2	6	12	21	17	11	–	–
120	26	2	6	12	24	20	14	–	–
150	30	2	6	12	28	24	18	–	–
200	37	2	6	12	35	31	25	–	–
250	43	2	6	12	41	37	32	–	–
300	60	2	6	12	48	44	38	–	–
400	60	2	6	12	56	52	46	–	–
<b>Ejector drilling</b>									
20	4	2	6	12	2	–	–	–	–
30	5	2	6	12	3	–	–	–	–
40	7	2	6	12	5	1	–	–	–
60	10	2	6	12	8	4	–	–	–
70	11	2	6	12	9	5	–	–	–
100	16	2	6	12	14	10	4	–	–
120	18	2	6	12	16	12	6	–	–
150	22	2	6	12	20	16	10	–	–
200	30	2	6	12	28	24	18	–	–
250	36	2	6	12	34	30	22	–	–
<b>Trepanning</b>									
120	26	2	6	12	24	20	12	–	–
150	26	2	6	12	24	20	12	–	–
200	30	2	6	12	28	24	18	–	–
250	30	2	6	12	28	24	18	–	–
300	30	2	6	12	28	24	18	–	–
400	30	2	6	12	28	24	18	–	–

Heating and cooling factors at 50% cutting time. The cooling effects are calculated at a tank temperature of 50° C.

## Types of cutting fluid

**Neat cutting oils:** ie. oils not mixed with water, are often a combination of mineral and fatty oils along with other EP (extreme pressure) additives. This mixture must be kept between 30 – 40° C or it will decompose.

Oil cutting fluids promote tool life and uniform chip breaking, and are more straightforward to employ than emulsions.

**Oil emulsions:** are dispersions of oil in a water carrier, combining the oil's lubricating properties with the heat transfer capacity of water. Numerous additives, such as emulsifiers, lubricators, anti-bacterial agents and EP additives, are required to maintain this mixture. These ingredients are supplied as concentrates, which must be carefully prepared by the user following a defined recipe and in clean, controlled conditions.

Emulsions can be more suitable for high speed machining operations, or situations where multiple machines are fed by a central fluid supply. They also clean the workpiece while in use, which oils do not. However their preparation can be complicated, and the mixture must be carefully monitored and maintained, both during use and while machines are idle.

## Recommendations

**Oil:** is recommended as the first choice for the following reasons:

- Longer tool life. The difference can be very significant and naturally depends on the choice of cutting oil and emulsion. Normally, however, 30% longer tool life is obtained when oil is used.
- More uniform chipbreaking and a larger chipbreaking range.
- When emulsion is used, there is a risk of stagnation if the machine is not operating continuously. When the machine is idle, the tank should be aerated in order to prevent the emulsion becoming stagnant.

**Emulsion:** is recommended as a second choice.

The arguments for the use of emulsion are the following.

- It can be complicated to use straight oil if drilling is performed on a line of machines or on a group of machines with a central system.
- Drilling is performed on a machining centre where most of the machining is high speed machining, secondary operations.
- With emulsion, the workpiece is cleaned during the machining process. When oil is used, it can sometimes be necessary to wash the workpiece to remove the oil prior to the next operation or storage.

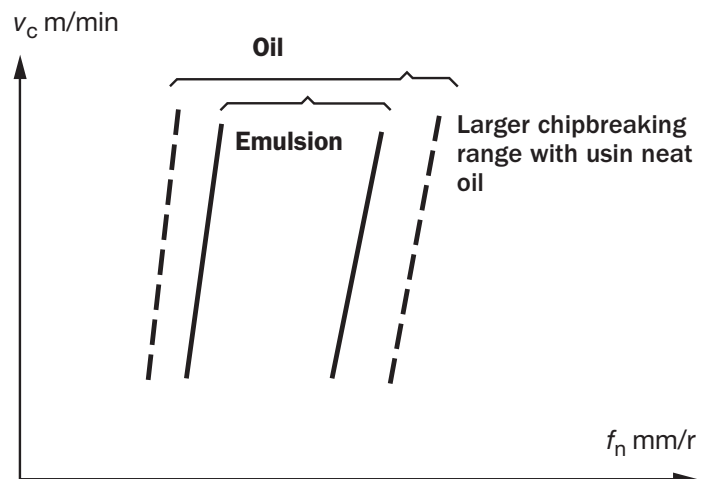

## The Ejector system

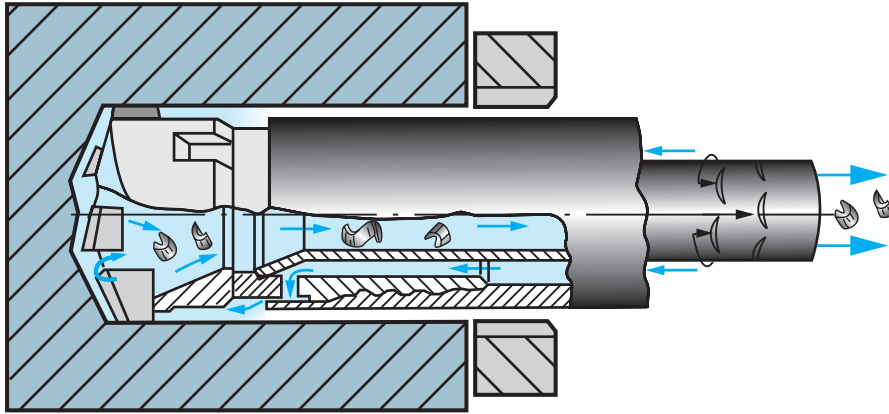

The Ejector system is easy and inexpensive to apply in machines with horizontal spindle (lathes machining centres). It consists of drill head, outer tube, inner tube, connector, collet and sealing sleeve.

The drill head is mounted to the drill tube by means of a four-start square thread.

The drill tube and the inner tube are attached to the connector by means of a collet and a sealing sleeve.

The collet and sealing sleeve must be changed for different diameter ranges, i.e. drill tube diameters.

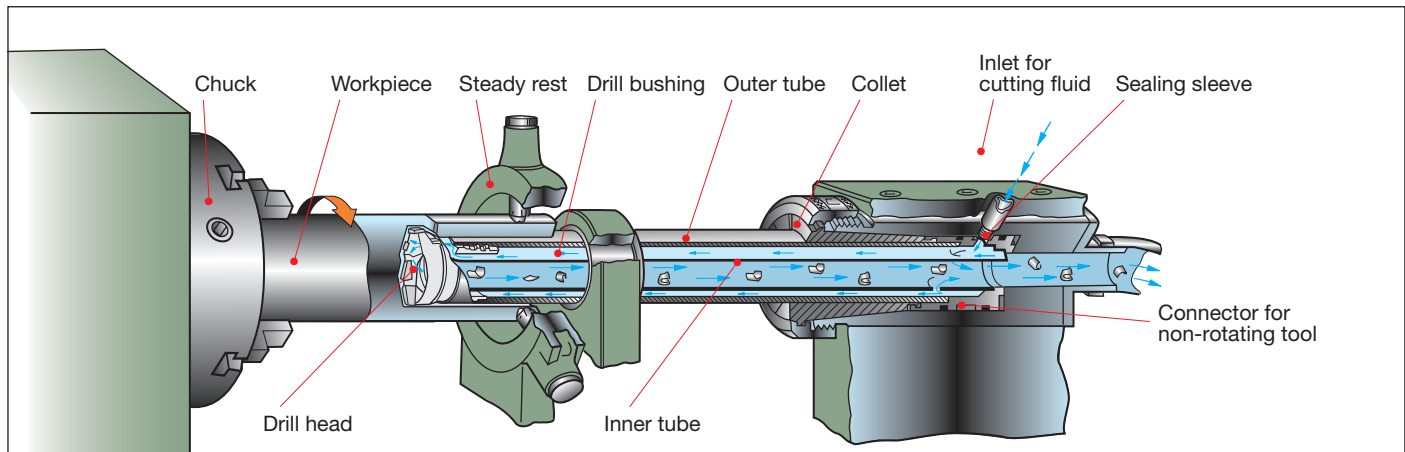

### Ejector system:

- Requires no seal between the workpiece and the drill bushing.
- Adapted easily to existing machines, preferable in conventional lathes, turning centres, machining centres and horizontal boring machines.
- For machining workpieces where sealing problems can arise.
- An advantage when it is possible to use a pre-drilled hole instead of a drill bushing for guidance, for example in machining centres.

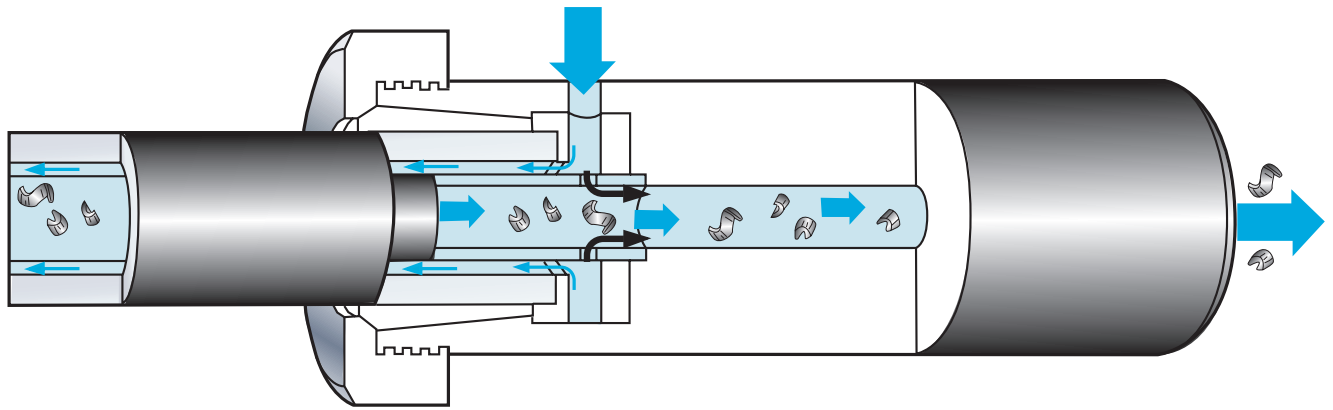

Connector for non-rotating drill

### Positioning of drill bushing in Ejector drilling

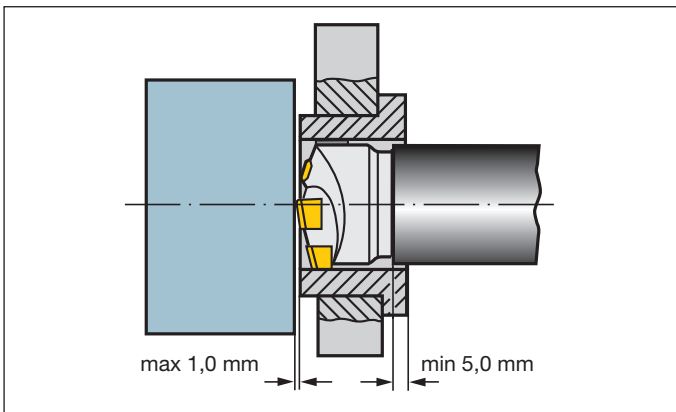

When the Ejector system is used no seal is required between the workpiece and the drill bushing. The drill bushing should be positioned as close to the workpiece as possible and, since the support pads are relatively short, the distance should not exceed 1,0 mm to ensure good initial penetration.

For an efficient cutting fluid supply, the length of the drill bushing should be at least 5,0 mm longer than the length that the drill head extends in front of the drill tube.

For applications with a rotating drill, it is important that the drill's support pads bear against the drill bushing. Otherwise, the peripheral insert will cut into the drill bushing thus enlarging it, which means that the drill will not get sufficient support during initial penetration.

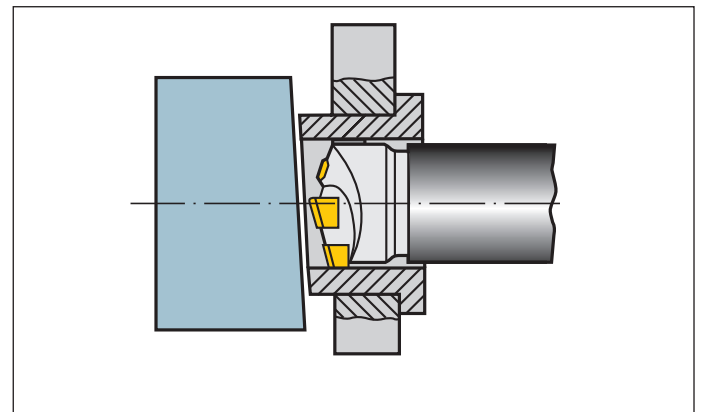

Drilling should not be started on interrupted or angular end faces. If such an operation is necessary, the bushing should conform to the angle of the workpiece face. An extra support pad is recommended for drilling into an inclined face and for cross hole drilling.

## Ejector drilling in modern machines



By pre-drilling a pilot hole with a CoroDrill 880 drill the need for a separate drill bush is eliminated, and makes Ejector drilling possible in modern NC-lathes and Machining centres.

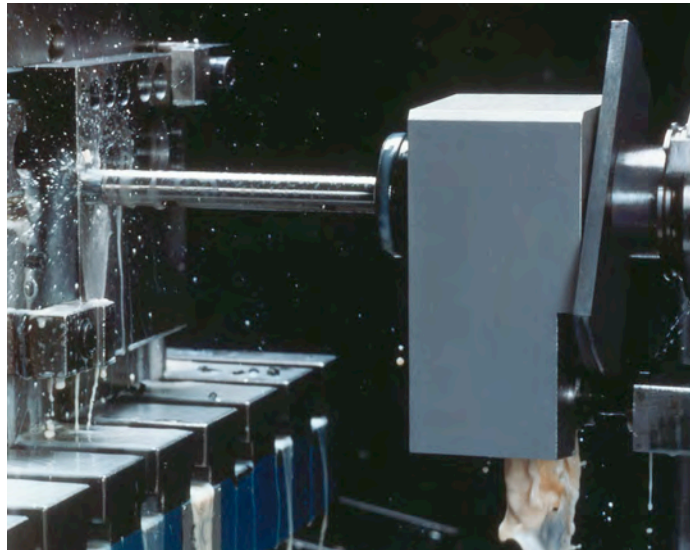

### Pilot holes for Ejector drilling

Method of producing pilot holes:

A deep pilot hole is required when not using a bush to guide the coolant. The tolerance of the hole is plus in relation to the drill diameter.

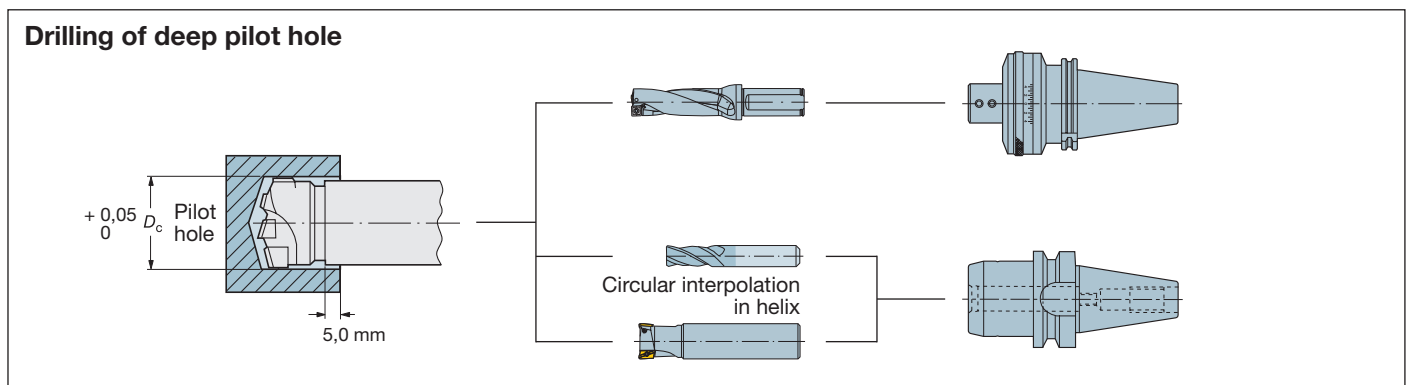

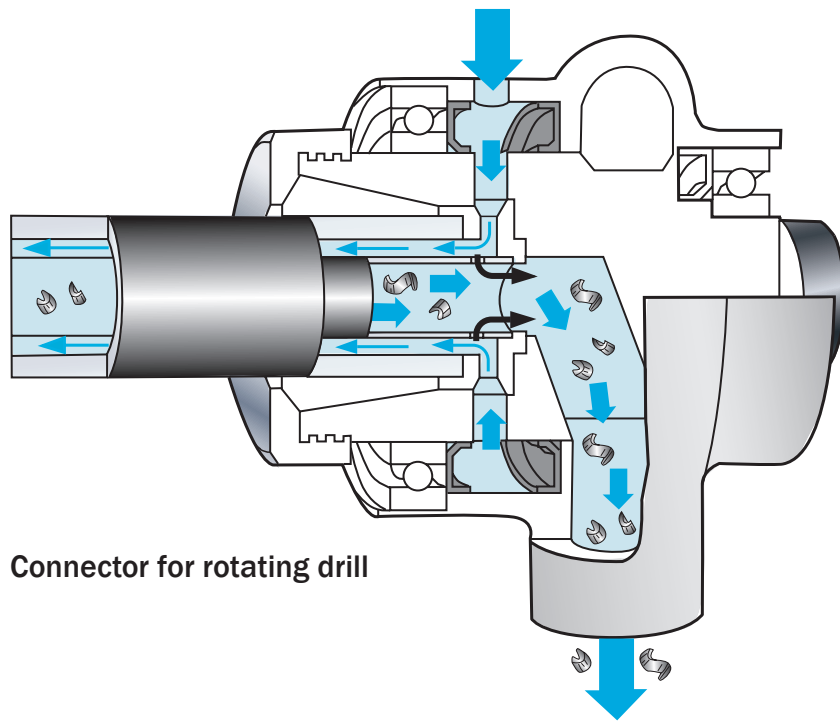

### Caution (rotating drill)

When using a machine with a rotating drill connector a stop to prevent the connector housing from rotating must be used.

If the seals or bearings are damaged the connector housing can rotate and consequently the supply tubing will be pulled round with the connector which could cause a serious accident.

If the rotating connector has not been used for some time, check that it will freely rotate before the machine spindle is started.

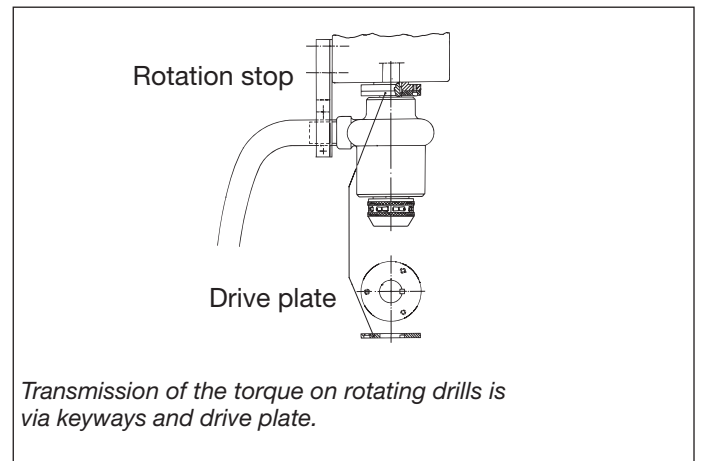



## The Single Tube System – STS

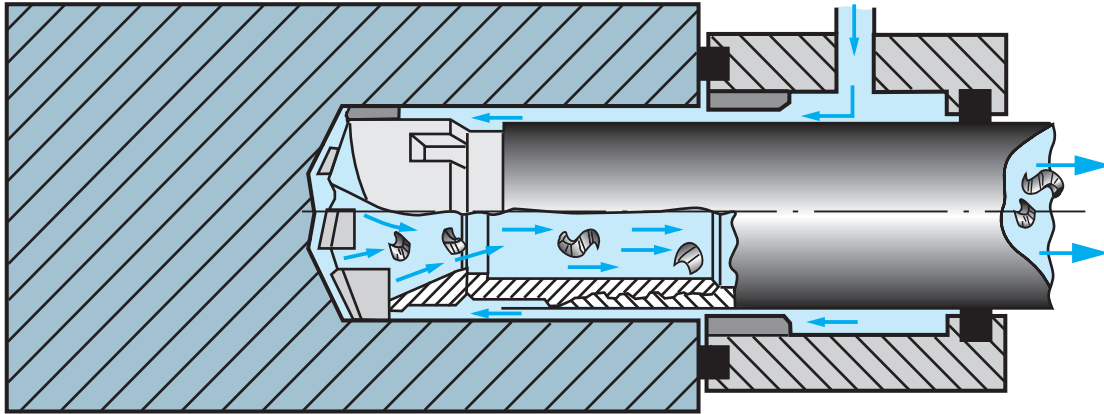

### The first choice for high productivity

The Single Tube System is based on external cutting fluid supply and internal chip transport.

As a rule, the drill head is screwed onto the drill tube.

The cutting fluid is supplied via the space between the drill tube and the drilled hole. The cutting fluid is then removed along with the chips through the drill tube.

The velocity of the cutting fluid is so high that chip transport takes place through the tube without disturbances.

Since chip evacuation is internal, no chipflute is required in the shank, so its cross-section can be made completely round, which provides much higher rigidity than in the gun-drill system. The productivity for the STS drilling is up to 6 times higher than for gun drilling.

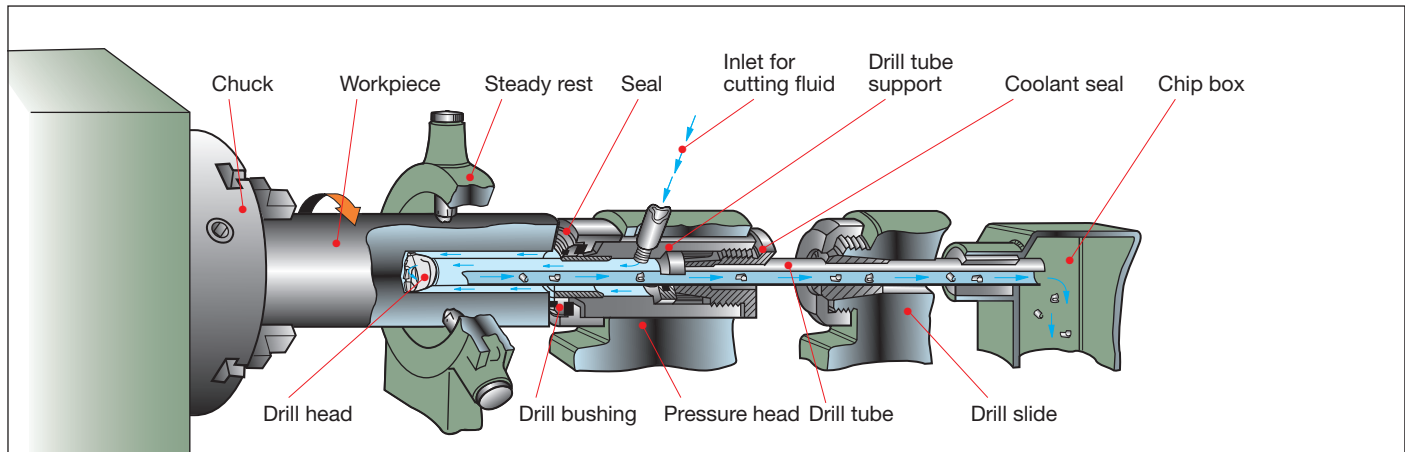

### STS system :

- In materials with poor chip forming properties such as stainless steel, and low-carbon steel.
- In materials with an uneven structure when chipbreaking problems exist.
- More advantageous for long series production.
- Uniform and extremely long work pieces.
- For hole diameters larger than 200 mm.
- Requires special deep hole drilling machine.



### Example STS-drilled components



Propeller shaft.

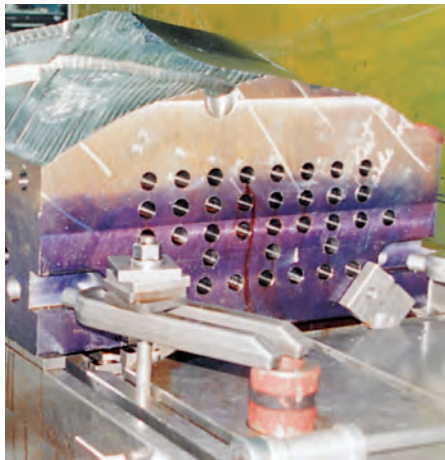

Coolant holes in a mould base.



Heat exchangerplate for steam generator.

### Deep hole drilling machine equipment – STS-system

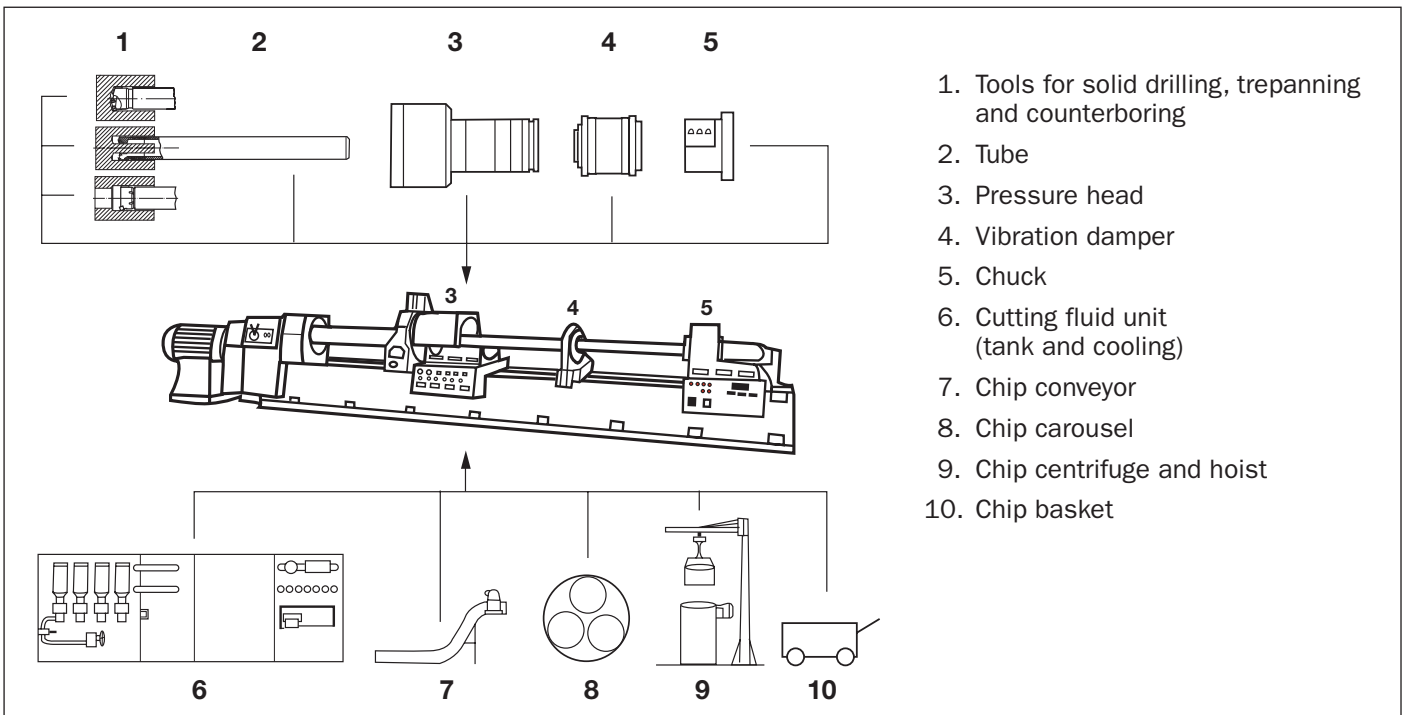

## Setting up the STS and Ejector systems

### Stationary drill

- The combined arrangement of a stationary drill and rotating workpiece is generally employed on workpieces which are symmetrical about their axes of rotation, on lathes and deep hole drilling machines.
- Compared to a rotating drill, this method produces straighter holes and results in less wear on the drill bush.
- The connector shank must be accurately aligned to provide a common axis of rotation with the machine spindle.
- The total run-out between drill bush and machine spindle should not exceed 0,02 mm.

### Rotating drill

- Rotating drill and stationary workpiece are employed on both symmetrical and non-symmetrical workpieces.
- Setting up the machine spindle must be carried out with great accuracy, with the run-out, measured on the inside taper of the connector, not to exceed 0,02 mm.

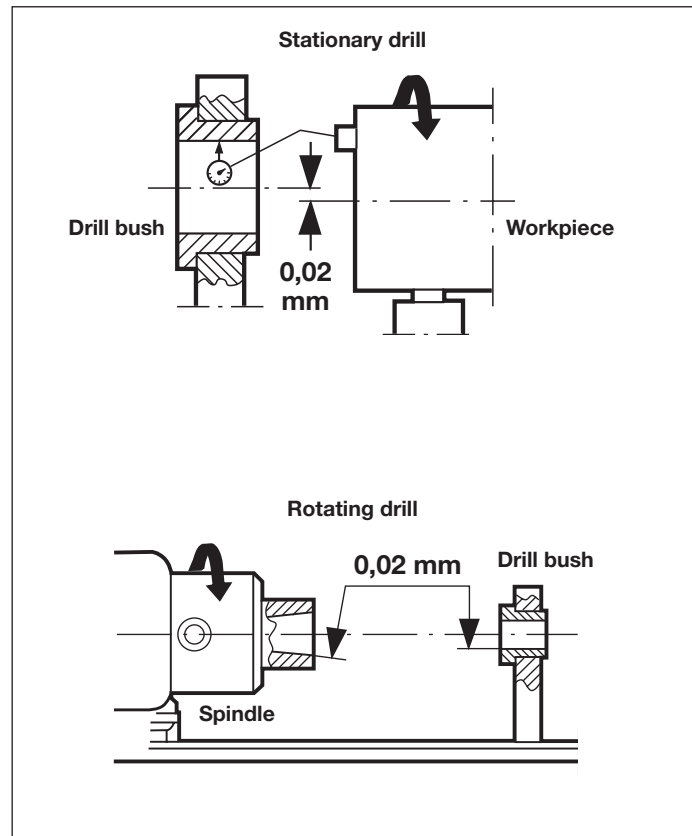

### Drill bush design

Drill bushings guide the drill head into the workpiece during the initial stages. To achieve long tool life and holes of good quality, the drill bushing is ground to the same nominal diameter as the drill head but on the plus side of the tolerance (as shown in the table).

A suitable choice is a cemented carbide bushing of grade CG25 or CG40.

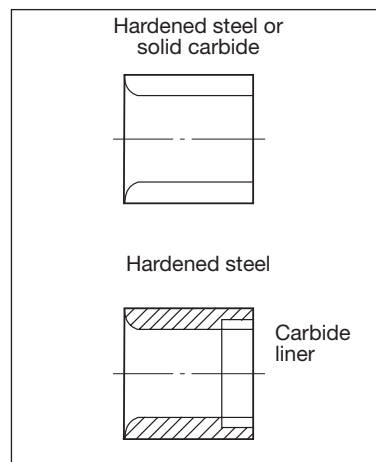

Nominal bushing size	Tolerances (G6)
12,60 – 18,00	+0,006 – +0,017
18,01 – 30,00	+0,007 – +0,020
30,01 – 50,00	+0,009 – +0,025
50,01 – 80,00	+0,010 – +0,029
80,01 – 120,00	+0,012 – +0,034
120,01 – 180,00	+0,014 – +0,039
180,01 – 250,00	+0,015 – +0,044
250,01 – 315,00	+0,017 – +0,049
315,01 – 400,00	+0,018 – +0,054
400,01 – 500,00	+0,020 – +0,060

**Example:**  
Drill diameter 35,95 mm. Drill bushings should be manufactured to diameter 35,959 to 35,975 mm.

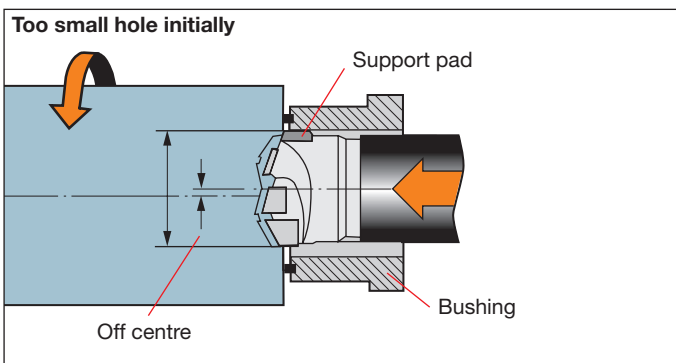
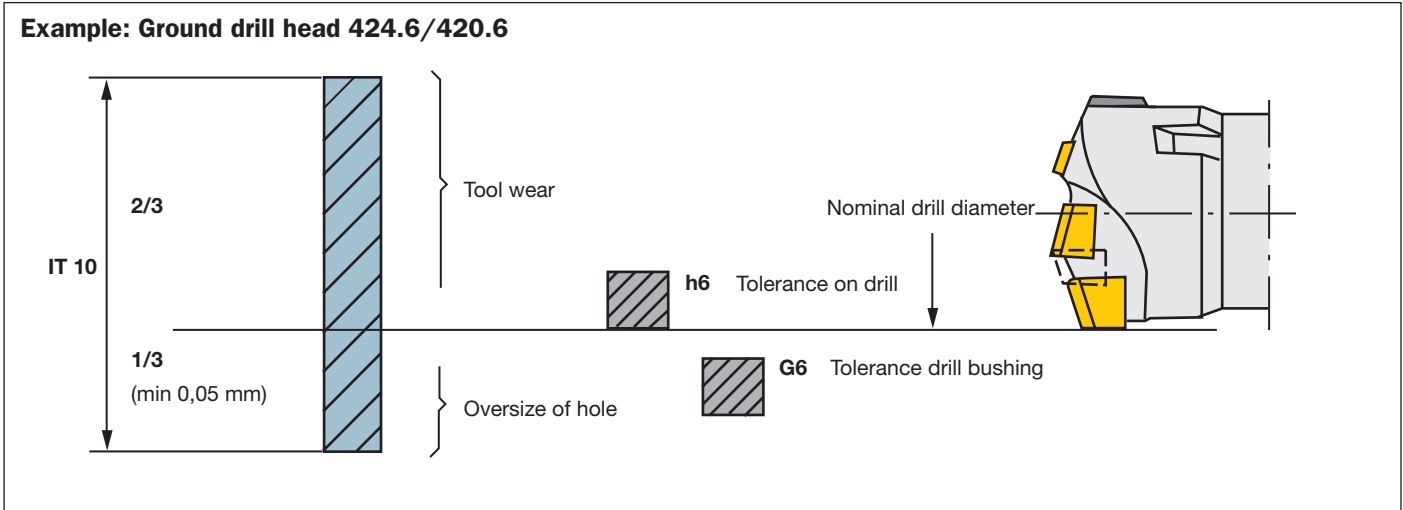

**Drill bush too large**

A too large drill bushing causes initially a too small drilled hole when the cutting forces press the drill's support pads against the drill bushing.

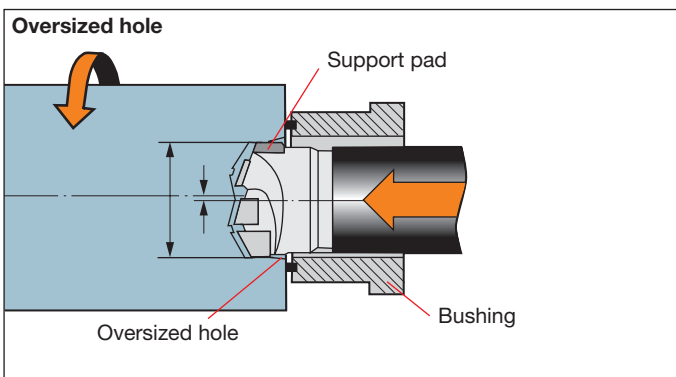

When the support pads climb up onto the rim of the hole, the drill is pressed over against the other side and the peripheral insert creates an oversized hole.

With a brazed drill head, the radial offset between the drill and the workpiece will gradually disappear. This results in the start of the hole becoming oversized – “Bellmouth”.

For drill bushing recommendations, see page 136.

The design of the bushing is an important factor in determining the quality of the drilled hole.

- Excessive clearance reduces the life of the drill.
- Dimensional accuracy has an influence on surface quality and straightness of the hole.
- Cemented carbide bushing lasts at least ten times longer than a steel bushing.
- In some cases, rotating bushings are used to reduce wear.

A new bushing should be 0,005 mm larger than the drill. The bushing becomes worn and should be replaced when the clearance is greater than 0,015 – 0,02 mm between the drill and the bushing if close tolerances are required.

## Machining recommendations

There are four factors that, in varying degrees, affect the choice of economical cutting data in both Ejector and STS drilling, namely:

1. Chip formation (suitable chip form)
2. Cutting force (available machine power)
3. Tool life (length of life)
4. Surface finish and tolerance (as specified on drawings)

One of the points that guarantees the functioning of the Ejector and STS drills is trouble-free movement of chips through the drill head and inner tube. This is why chip formation is listed as the No. 1 priority. The second priority is available machine power. Tool life, as a critical bearing on the choice of economical cutting data, is a less important factor.

### Chip formation

With its short-chipping properties, cast iron seldom causes chip formation problems. When drilling steel, good chip formation is obtained by a combination of chip-breaker geometry, speed, feed and for certain materials, the choice of cutting oil. The essential thing is that the chips must be formed and broken away to yield a shape and size that will flow smoothly and steadily through the chip ducts.

The picture below shows the three different chipforms generated by the central, intermediate and peripheral insert as a consequent of the cutting speed.

### Chip formation

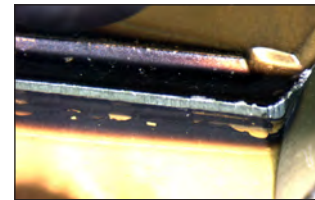
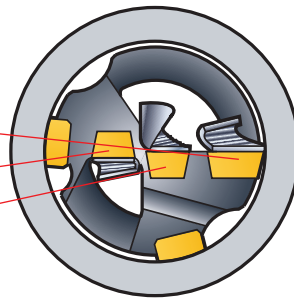
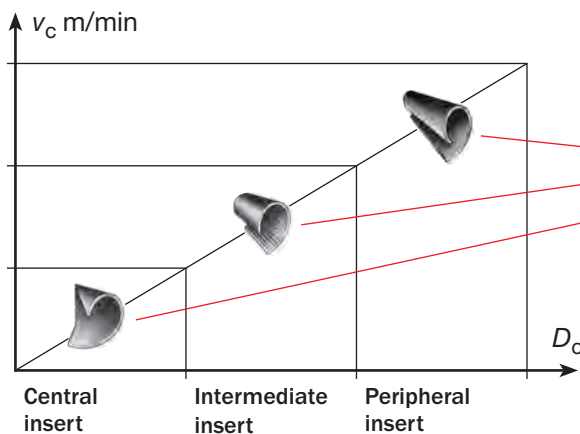

Normally max wear occurs on peripheral insert corner

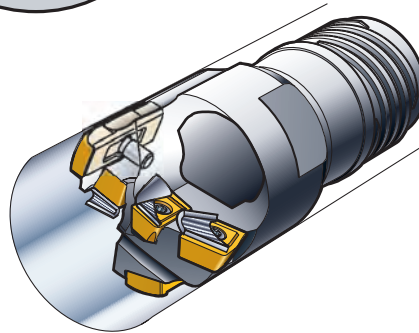

### Chipbreaking

Of primary importance in drilling operations is transporting the chips away from the cutting edges of the drill, i.e. obtaining satisfactory chipbreaking. Excessively long and large chips can get stuck in the chip ducts. A suitable chip is as long as it is wide. However, the chips should not be broken harder than necessary, since chipbreaking is power consuming and the heat that is generated increases wear on the cutting edges. Chips with a length 3–4 times their width can be acceptable, provided that they can pass through the chip duct and drill tube without difficulties. Chip formation is affected by the work material, chipbreaker geometry, cutting speed, feed and choice of cutting fluid.

## Influence of cutting speed and feed

For most materials it is generally possible to make wide variations in both feed and cutting speed in order to obtain the desired production result. However, when determining the cutting data for some, difficult to machine materials, wear is entirely dependent on chipbreaking. It may happen in testing that good chip formation is achieved from the central and intermediate tips while the peripheral tip gives an un-acceptably long chip.

In order to get shorter chips, the feed is usually increased, which may result in the chips being too tight at the central and intermediate tips.

Where a thick compacted chip, in the form of a long strip, is obtained from the central tip, it can be overcome by reducing the feed to correct the chip form.

The speed can then be reduced (this has the effect of shortening the chip) so that an acceptable chip is obtained from the peripheral tip. Certain materials are difficult to machine, e.g. nitrited steel; consequently, it may be necessary to slow the cutting speed down to about 40 m/min, in order to get acceptable chipbreaking from all tips. The following method is recommended for the choice of cutting data:

1. Check that the motor rating is sufficient. Remember to make allowances for the machine's efficiency.
2. Select cutting speed from the lower part of the 70-100 m/min range.
3. Start at low end of feed range and work upwards.
4. Carry out chipbreaking trials. A few seconds run is sufficient to obtain enough chips and thus determine the cutting data.

## Chip breaking influenced by speed and feed

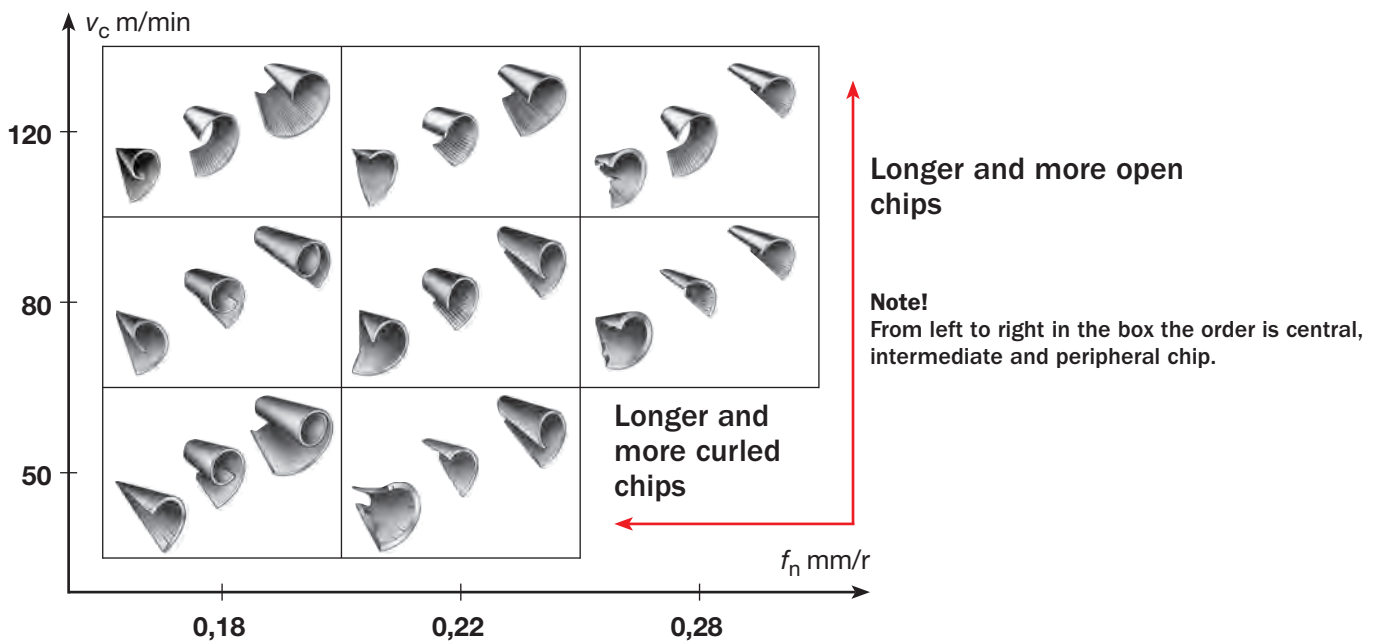

Chipbreaking is affected by cutting speed and feed. The chipbreaking range for a drilling tool is illustrated in the picture above. The tool is test-run in the same work material but with different combinations of cutting speed and feed. Once a number of values have been run, the different chip forms obtained are studied. The portion of the diagram where satisfactory chip forms are obtained constitutes the chipbreaking range for the drill and material in question.

Shorter chips are obtained by increasing the feed and/or reducing the cutting speed. The most economical alternative is chosen from among the possible cutting data combinations.



## Choice of cutting data

The primary consideration when selecting cutting data for drilling is to obtain satisfactory chipbreaking. The following steps show how to systematically choose the optimum cutting data

- Find the work material in the cutting data recommendations.
- Choose the appropriate cemented carbide grade or grade combination for the given machining conditions.

Different coated cemented carbide grades can be used for the indexable insert drill heads. A grade with higher wear resistance can be used at the periphery where the cutting speed is greatest, while the central insert requires a tougher grade. The choice of grade in relation to the work material is the same as for turning. Since the cutting speed rarely exceeds 100 m/min, the extremely wear resistant but brittle grades are secondary. Most important are safety against breakage and avoiding built-up edge.

- Choose approximate cutting data from the cutting data recommendations.

- Calculate the maximum permissible cutting speed in view of the machine's maximum spindle speed and support pad wear. Support pad wear increases considerably at cutting speeds above 100 m/min.
- Calculate the power requirement and make sure that reserve power is available for tool wear and slightly altered cutting data. Idling power can easily be measured on machines with power meters.

Ejector / STS system DEEP HOLE DRILLING

### Inserts for CoroDrill® 800.24 and 800.20 solid drill heads

Insert size	Insert code	Coromant grades					GC = Coated grade (ISO = HC)					
		P	M	K	N	S						
05	Central 800-05 03 08M-C-G	*	*	*	*	*	5.56	9.87	3.18	0.8		
06	800-06 T3 08M-C-G	*	*	*	*	*	6.35	9.87	3.97	0.8		

Dimensions, mm:  $D_c$ ,  $l$ ,  $s$ ,  $r_c$

For carbide grade or grade combination, see ordering page for insert and drill respectively.

Ejector / STS system DEEP HOLE DRILLING

### Cutting data for CoroDrill® solid drill heads 800.24 and 800.20

ISO	CMC No.	Material	Specific cutting force $k_{fc}$ , N/mm <sup>2</sup>	Hardness HB	Geometry/grade	Support pad grade	Cutting speed $v_c$ , m/min	Feed, $f_n$ , mm/r
P	01.1	Unalloyed Non-hardened 0.1-0.25% C	2000	90-200	G/1025 G/1025 G/1025	P1	70-130	0.11-0.41
	01.2		2100	125-225	G/1025 G/1025 G/1025	P1	70-130	0.11-0.41
	01.3		2180	150-250	G/1025 G/1025 G/1025	P1	70-130	0.11-0.41
	01.4		2320	180-275	G/1025 G/1025 G/1025	P1	70-130	0.11-0.41
02.1	Low alloy Non-hardened	2100	150-280	G/1025 G/1025 G/1025	P1	70-120	0.11-0.41	

Specific cutting forces, see cutting data tables for the drill used.

Cutting speed (m/min)

$$v_c = \frac{\pi \times D_c \times n}{1000}$$

Net power  $P_c$  kW

$$P_c + P_\mu = \frac{f_n \times v_c \times D_c \times k_{fcz}}{240 \times 10^3} \times 1,34$$

## Cutting Data Module



## Cutting Data Module

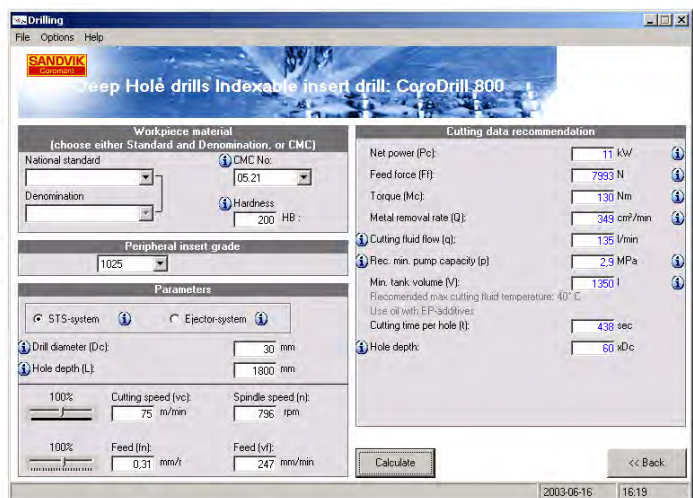

The Cutting Data Module is available at internet ([www.sandvik.com](http://www.sandvik.com)) alternatively contact your Sandvik Coromant representative to get the Cutting Data Module to simplify your choice of cutting data.

**Example:**

In a long-term test, tool life has been plotted as a function of feed/rev at cutting speed of 60 m/min and 100 m/min.

**Lowest tool cost**, i.e. the longest life per drill is obtained with the following data:

Cutting speed	$v_c$	= 60 m/min
Feed/rev	$f_n$	= 0,21 mm/rev
Feed/min	$v_f$	= 120 mm/min
Tool life	$l_m$	= 20 m/drill
Drill time/metre	$\frac{l_m}{v_f}$	= $\frac{1000}{120} = 8,3$ min

**Highest material removal rate**, i.e. shortest drill time was obtained with the following data:

Cutting speed	$v_c$	= 100 m/min
Feed/rev	$f_n$	= 0,28 mm/rev
Feed/min	$v_f$	= 280 mm/min
Tool life	$l_m$	= 14 m/drill
Drill time/metre	$\frac{l_m}{v_f}$	= $\frac{1000}{280} = 3,6$ min

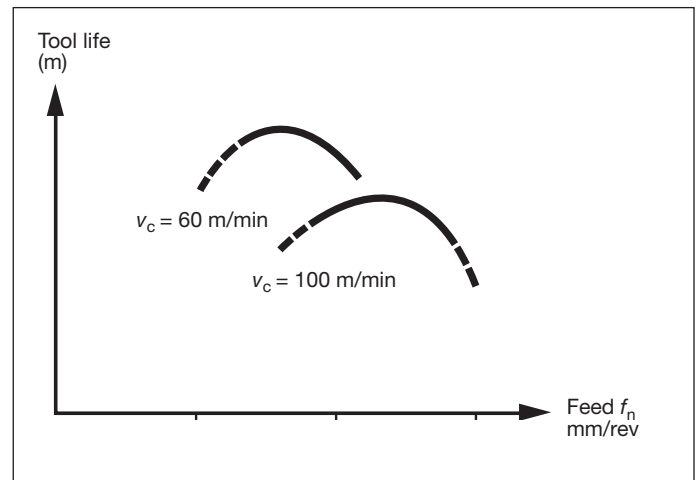
**Case 1 – High machine cost**

Assume that the tool cost is € 65/drill and the fixed cost is € 100/h, i.e.  $\frac{100}{60}$  /min

	Lowest tool cost $v_c = 60$ m/min	Highest material removal rate $v_c = 100$ m/min
Fixed cost €/m	$\frac{100}{60} \times 8,3 = 13,83$	$\frac{100}{60} \times 3,6 = 6$
Tool cost €/m	$\frac{65}{20} = 3,25$	$\frac{65}{14} = 4,64$
Machining cost €/drilled m	≈ 17,10	≈ 10,60

**Case 2 – Low machine cost**

Assume instead that the fixed cost is € 16/h, i.e.  $\frac{16}{60}$  /min

	Lowest tool cost $v_c = 60$ m/min	Highest material removal rate $v_c = 100$ m/min
Fixed cost €/m	$\frac{16}{60} \times 8,3 = 2,21$	$\frac{160}{60} \times 3,6 = 0,96$
Tool cost €/m	$\frac{650}{20} = 3,25$	$\frac{65}{14} = 4,64$
Machining cost €/drilled m	≈ 5,40	≈ 5,60

**Case 3 – High machine cost/low workload**

Assume that the figures in case 1 apply but that the machine is only used 15% of the shift due to a low workload in the shop.

	Lowest tool cost $v_c = 60$ m/min	Highest material removal rate $v_c = 100$ m/min
Fixed cost €/m	$0,15 \times \frac{100}{60} \times 8,3 = 2,08$	$0,15 \times \frac{100}{60} \times 3,6 = 0,90$
Tool cost €/m	$\frac{65}{20} = 3,25$	$\frac{65}{14} = 4,045$
Machining cost €/drilled m	≈ 5,30	≈ 5,50

**Note!**

In the above calculation, the cost figures are estimated. Please use your own figures.



## The gun drill system

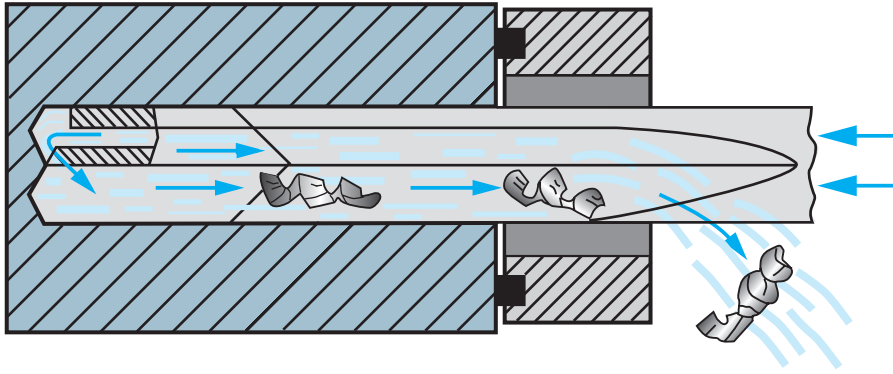

The gun drill system uses the oldest principle for cutting fluid supply. The cutting fluid is supplied through a duct inside the drill and delivers coolant to the cutting edge,

after which it removes the chips through a V-shaped chip flute along the outside of the drill. Due to the V-groove, the cross-section of the tube occupies 3/4 of its circumference.

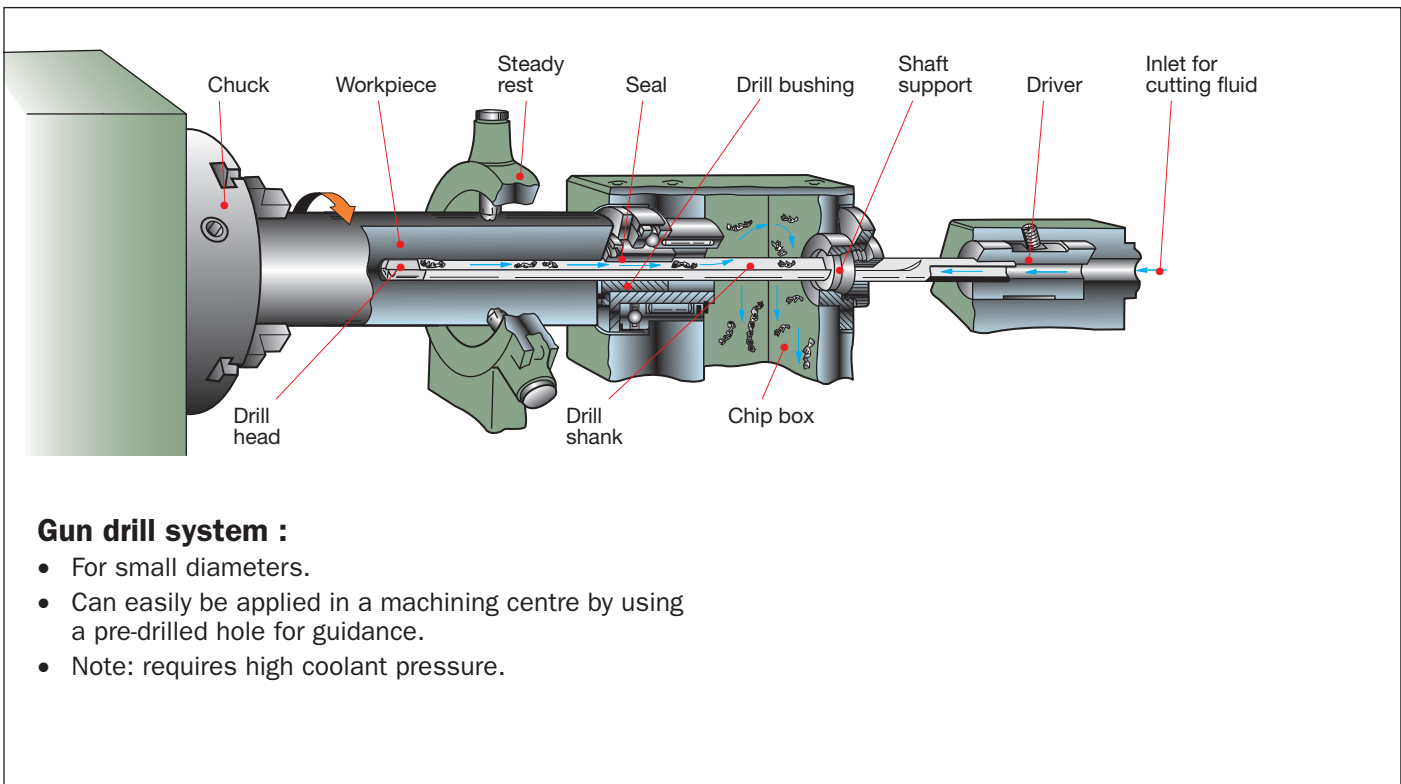

## Gun drilling system

- Cutting fluid is fed through the drill, and the chips are transported away along the V-shaped flute of the drill
- A seal between the workpiece and the drill bush as well as in the rear of the chip box is necessary
- Approx. 50% higher coolant pressure are required compared to the STS system
- Drilling of very hard materials and when chipbreaking is difficult
- Fine tolerances and good finish is obtained

## Machines

- Best results are obtained on machines designed specifically for gun drilling
- Conventional machines can be modified for gun drilling
- Suitable for deep hole drilling on M/C:s
- The feed mechanism with constant, preferably stepless mechanical feed
- An electrical interlock to prevent the machine starting up without coolant supply, coolant pressure gauge, safety valve for coolant supply and coolant tank level indicator is recommended
- An adjustable feed overload device is recommended

## Drill bush

- The hole in the drill bush should be ground to the same nominal diameter as the drill with a tolerance of ISO H6
- The drill bush should be of carbide and should be replaced when the diameter becomes to 0,02 mm oversize

## Filtration

- Adequate coolant filtration (centrifuge or magnetic), down to 5–10  $\mu\text{m}$  increases tool-life

## Alignment

The drill bush should be accurately aligned with the machine spindle and the drill within 0,02 mm (B)

- When drilling long workpiece, steadies should be used on both workpiece and drill shank

## Workpiece

- The workpiece must be securely held. Hydraulic clamping is preferable to pneumatic clamping
- The workpiece centre should be smaller than the drill diameter, if not a special guide bush (A) will be required

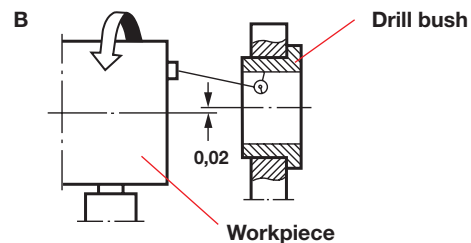
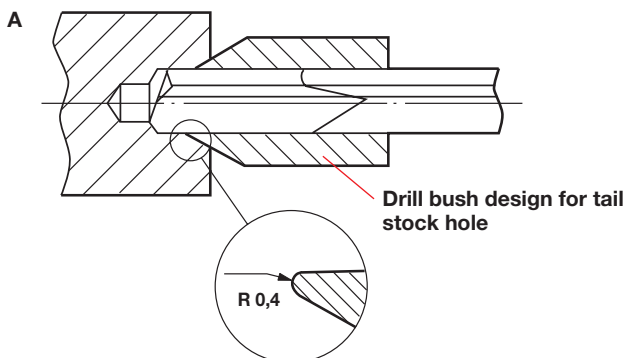

## Gundrilling in machining centres

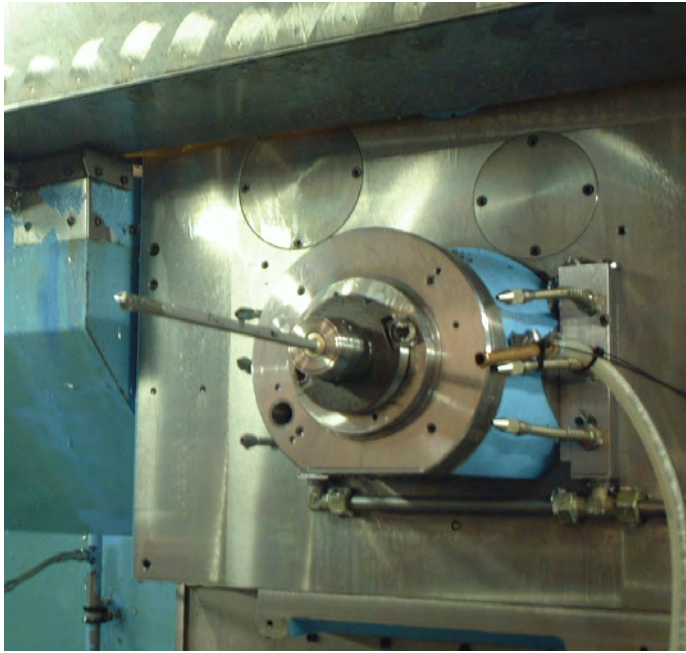

### Note!

Use emulsion with min 10-15% mixture or pure oil. Make sure that the coolant pressure is sufficient, see page 117.

### Methods of producing guide holes

The following procedure should be used for drilling the guide hole:

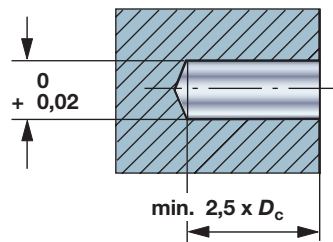
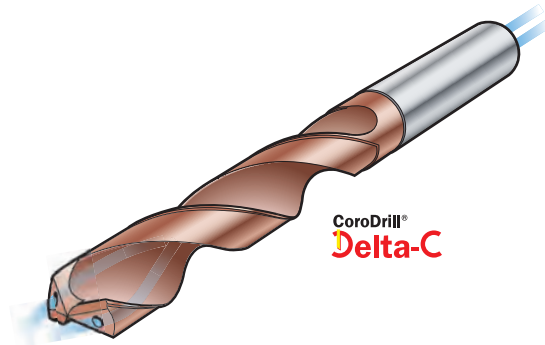

#### 1. Pilot hole as guide bush.

The guide hole should be drilled to tolerance +0,01 to 0,02 mm (H7) larger than gun drill diameter

CoroDrill Delta-C is a suitable drill for this operation

#### 2. Feeding gun drill into guide hole

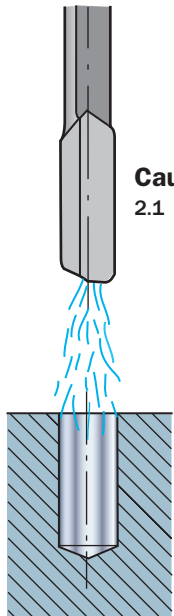

#### Caution:

2.1 Outside of the hole, the gun drill must not be rotating

2.2 Feed to insert the drill into the guide hole while supplying cutting fluid

#### 3. Start drilling

3.1 Start cutting rotation

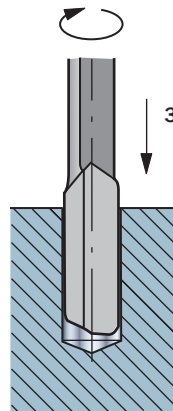

3.2 Start cutting feed

#### 4 After the hole been drilled

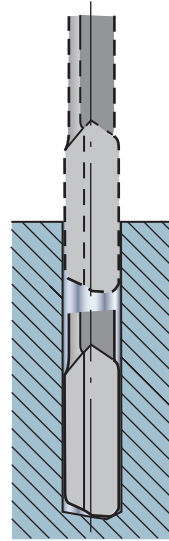

4.1 Rapid return

4.2 Stop at the guide hole position 2.2

4.3 Stop cutting rotation and coolant supply

4.4 Pull out the gun drill from the workpiece

## Gundrill – regrinding equipment

### Regrinding of gun drills

Guaranteed performance can only be ensured by accurate regrinding which is normally required when the flank wear reaches 0,2-0,4 mm for drill diameters up to 15 mm, and 0,4-0,6 mm for larger sizes. Depending on the required hole tolerance and workpiece material, drills can be reground 15-20 times, with a tool life of 10-20 metres between regrinds.

Regrinding can be carried out on a conventional tool and cutter grinder with the aid of a grinding fixture. Regrinding can also be carried out on a gun-drill grinding machine. The fixture and the grinding machine offer the following advantages:

- Accurate regrinding.
- Reproduction of original cutting geometry.
- Simple and quick operation.

Grinding fixture and grinding machine are available on request.

### Grinding machine TBSM 2-32

Specialized for grinding of gundrills. For diameters 2-32 mm. Also possible to grind chipbreakers.

#### Technical data

Table movement: 250 mm

Vertical movement: 160 mm

Worktable area: 133 x 470 mm

Grinding wheel diameter: 125 x 10 mm

(Double grinding wheel 80 x 10 mm)

Spindle speed: 2850 rpm 380V 50Hz



### Single-lip gundrill – grinding fixture TBSG 2,5-32

For regrinding of single-lip gundrills



### Twin-lip gundrill – grinding fixture ZLBSG

For regrinding of twin-lip gundrills



## Regrinding Single-lip gundrill

### Standard grind for single-lip drills up to 5.00 mm

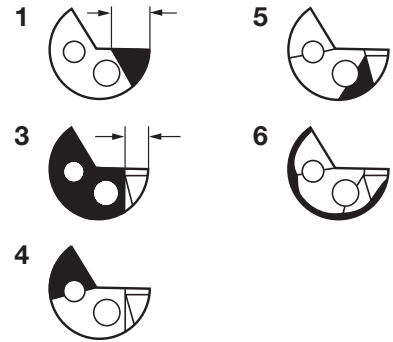
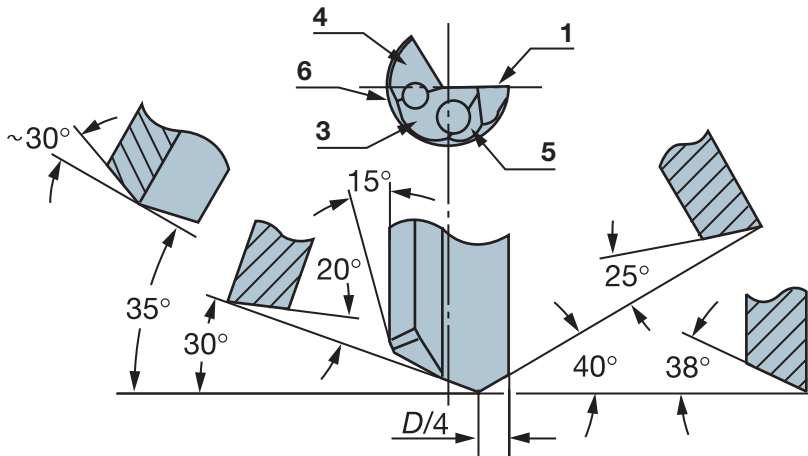

### Standard grind for single-lip drills between 5,00 – 20,00 mm

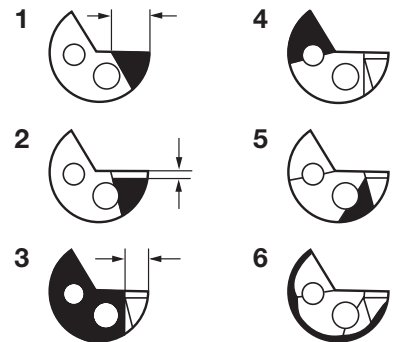
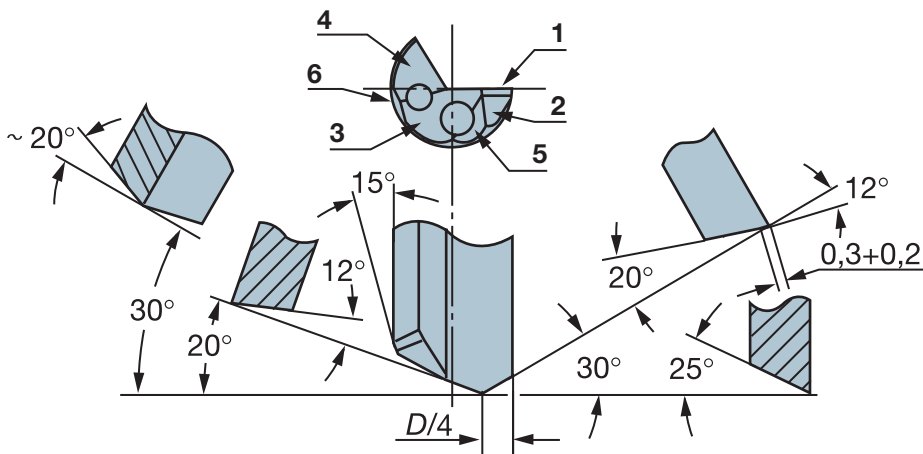

### Standard grind for single-lip drills above 20,00 mm

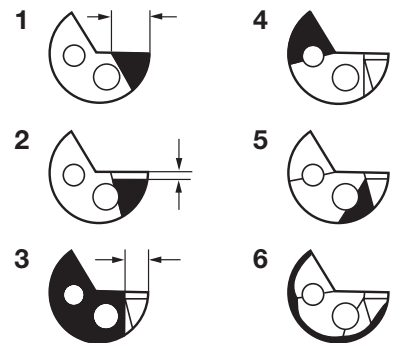
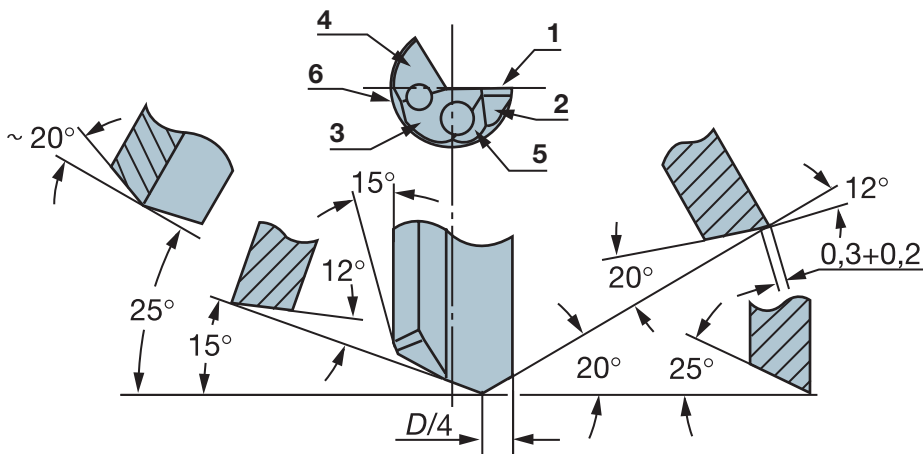

## Regrinding Twin-lip gundrill

### Standard grind for twin-lip drills 5.00 – 26,50 mm

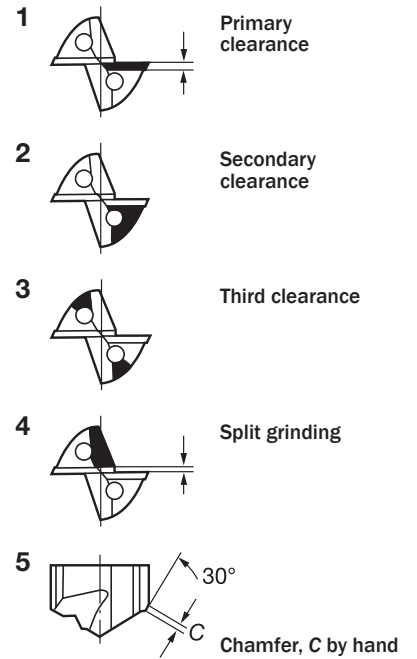
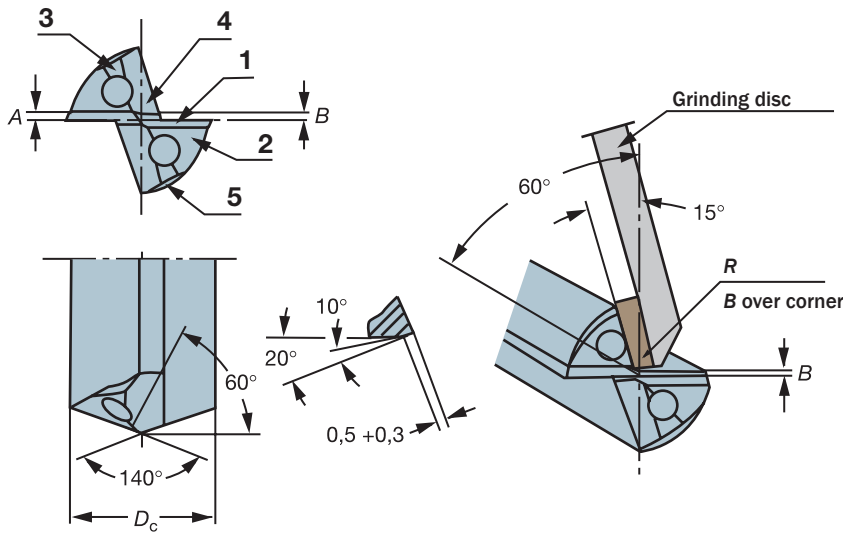

$D_c$	Dimensions, mm			
	A	B	C	R
5,00 – 10,00	0,4	0,2	0,5	1,0
10,01 – 15,00	0,5	0,3	0,6	1,5
15,01 – 20,00	0,6	0,4	0,7	2,0
20,01 – 26,50	0,7	0,4	0,8	2,5

### Grinding of chipbreaker on twin-lip drills

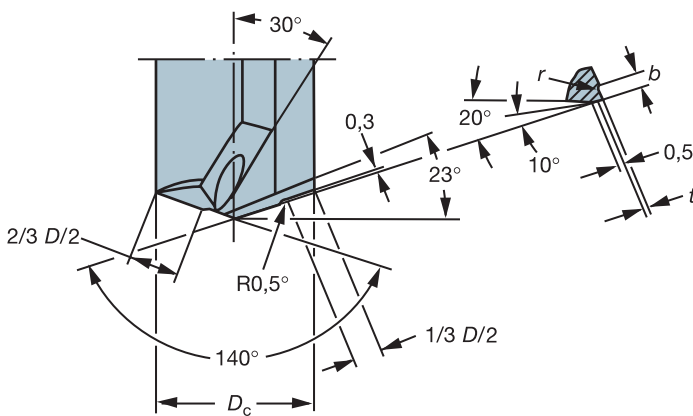
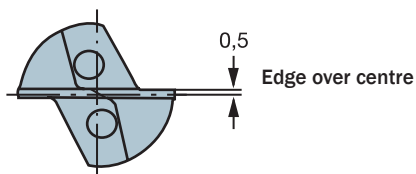

$D_c$	Chipbreaker, mm		
	b	t	r
5,00 – 9,00	0,9	0,25	0,8
9,01 – 11,00	1,1	0,30	0,8
11,01 – 14,00	1,2	0,35	0,8
14,01 – 17,00	1,3	0,40	0,8
17,01 – 20,00	1,4	0,45	0,8
20,01 – 23,00	1,5	0,50	0,8
23,01 – 26,50	1,6	0,55	0,8

## Balanced and unbalanced drills

Geometric design varies between different types of drills. When the drill tip is located in the centre, symmetry is obtained and the cutting forces balance each other out. The cutting speed decreases from the periphery in towards the centre, where the drill tip is virtually stationary and is pushed into the material.

This problem can be avoided by inward inclination of the centre part. The clearance on the insert increases and the axial pressure on the drill tip is considerably reduced. The asymmetric geometry which is obtained means that the cutting forces do not balance each other out.

In order to absorb the radial cutting forces on the drill periphery, these so-called “unbalanced drills” are provided with support pads. The resultant of the force should fall between the support pad and the guide pad, however bring closer to the support pad can result in an oversized hole.

By dividing the cutting edge into a number of cutting edges located on both sides of the centreline of the drill, it is possible to eliminate a large proportion of the forces on the support pad, see figure.

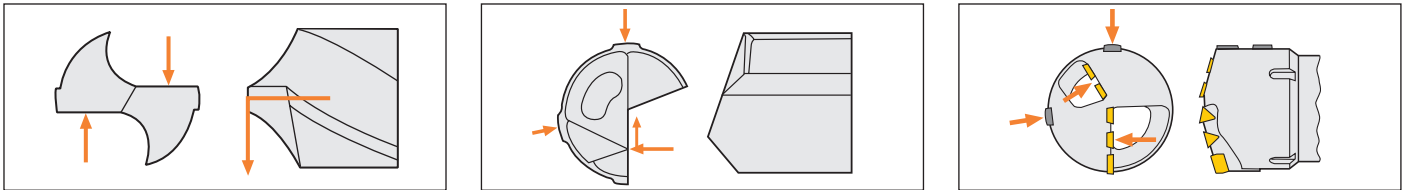

The cutting edge geometry of the drilling tool is the same in principle as for turning and milling. There is a rake angle  $\gamma_{fe}$  and an edge angle  $\beta_{fe}$ . The size of the clearance angle  $\alpha_{fe}$  is in proportion to the feed  $f_z$  and the diameter  $D_c$ . The feed angle  $\varphi_{fe}$  increases with increasing feed, which causes a reduced clearance on the cutting edge. This reduction is greatest nearest the centre. The clearance angle on the insert in the centre must therefore be made larger than in the periphery. The entering angle and the point angle affect the torque as shown in the diagram.

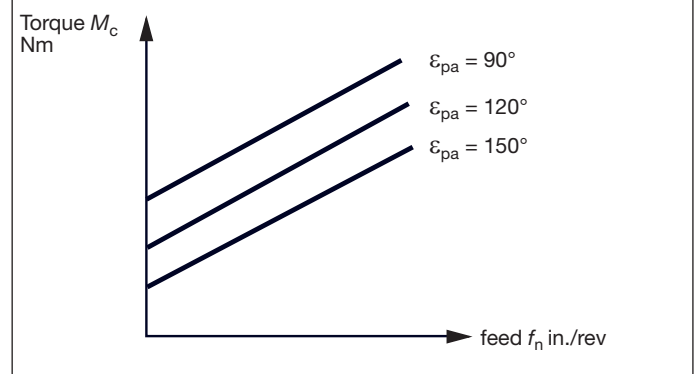
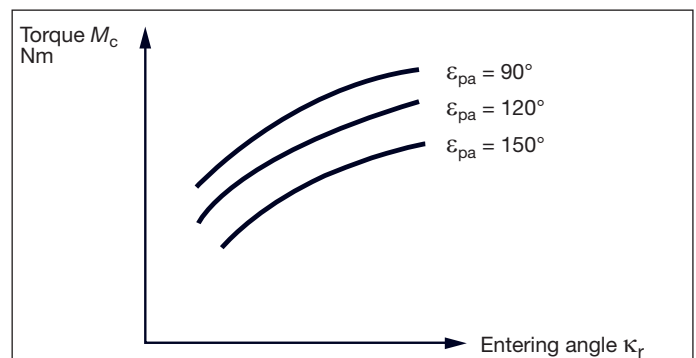

A large point angle gives a low torque. The torque increases with increasing feed and increasing entering angle.

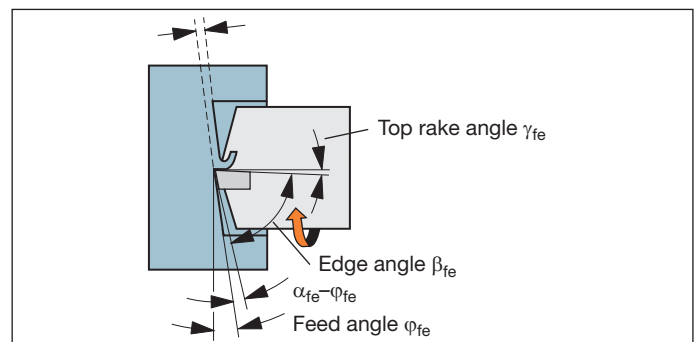
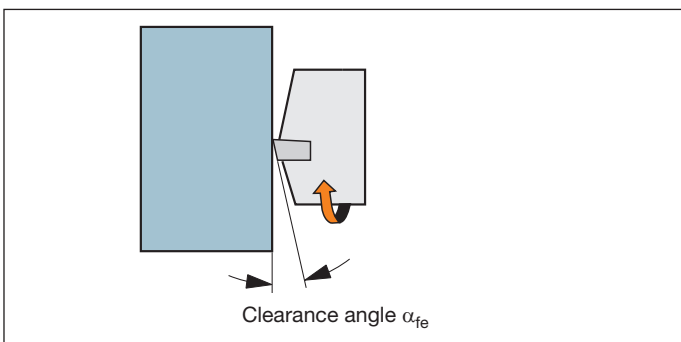
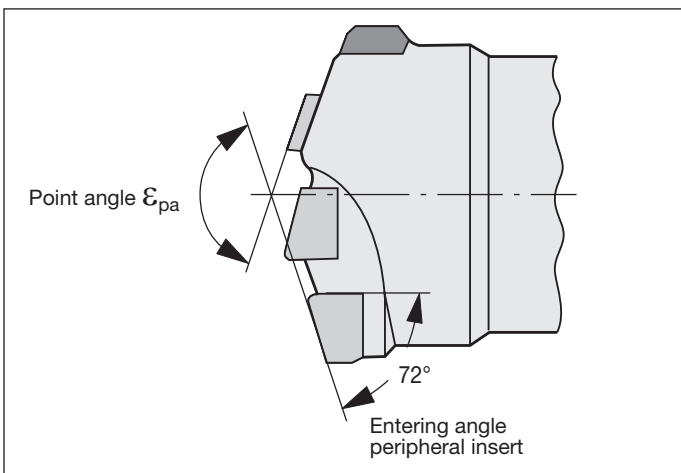



## Cutting data calculations

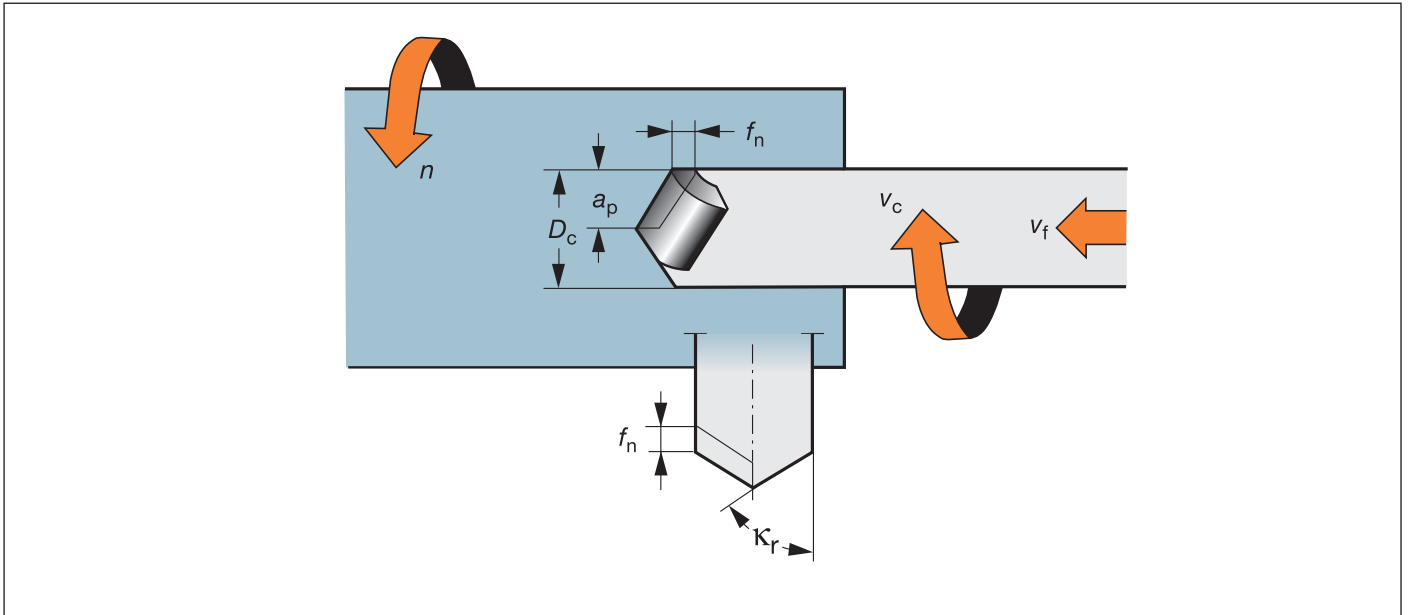

As far as cutting data calculations are concerned, drilling has many similarities to turning and milling. The cutting speed  $v_c$  is the difference in speed between the periphery of the drill and the wall of the drilled hole.

The depth of cut  $a_p$  is expressed in mm and is measured, as in the case of turning, on half the diameter.

<b>Cutting speed (m/min)</b>	$v_c = \frac{\pi \times D_c \times n}{1000}$
<b>Spindle speed (r/min)</b>	$n = \frac{v_c \times 1000}{\pi \times D_c}$
<b>Feed speed (mm/min)</b>	$v_f = f_n \times n$
<b>Metal removal rate (cm<sup>3</sup>/min)</b>	$Q = a_p \times f_n \times \frac{v_{c \max} - v_{c \min}}{2}$

### Terminology and units

$D_c$	Drill diameter	mm	$F_f$	Feed force	N
$a_p$	Cutting depth	mm	$F_{\mu}$	Feed force caused by friction	N
$v_c$	Cutting speed	m/min	$M_c$	Torque	Nm
$n$	Spindle speed	r/min	$M_{\mu}$	Torque caused by friction	Nm
$v_f$	Feed speed	mm/min	$P_c$	Net power	kW
$f_n$	Feed per rev.	mm/r	$P_{\mu}$	Power caused by friction	kW
$Q$	Material removal rate	cm <sup>3</sup> /min	$\kappa_r$	Cutting edge angle	Degrees
$k_c$	Specific cutting force	N/mm <sup>2</sup>	$q$	Cutting fluid quantity	l/min
$k_{c,0,4}$	Specific cutting force for $f_z = 0,4$	N/mm <sup>2</sup>	$\rho$	Cutting fluid pressure	Mpa

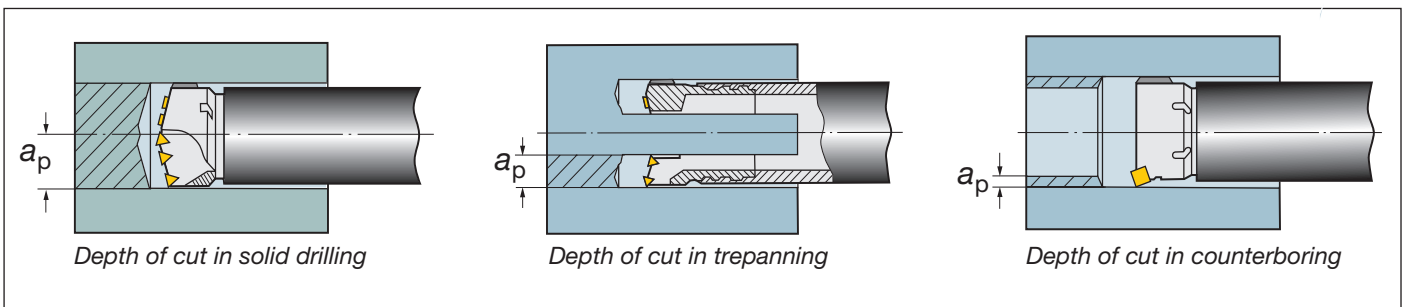

### Cutting forces

The cutting forces that arise during drilling are illustrated in the figure. The axial force  $F_f$  gives rise to an opposite feed force. The tangential cutting force  $F_c$  causes the torque  $M_c$  and  $F_p$  is the radial force that acts on the guide pad.

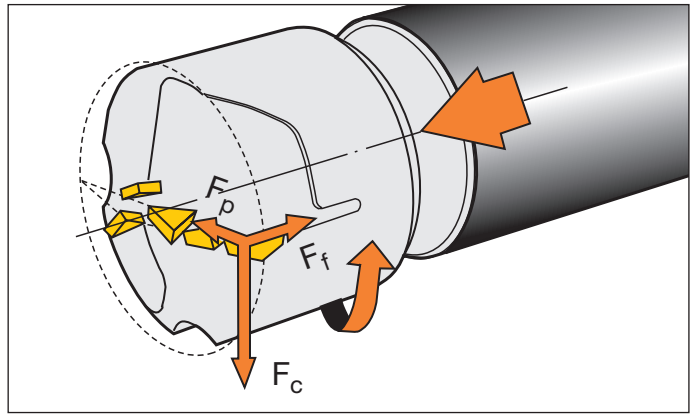

The cutting forces can be determined experimentally. If the specific cutting force  $k_c$  (N/mm<sup>2</sup>) for the material is known, the size of the cutting forces can be calculated.

Tangential force  $F_c = k_c \times f_n \times a_p$  (N)

The specific cutting force, like the coefficient of friction for support pads, is difficult to calculate exactly. The formulas for feed force, torque and power requirement are therefore only approximate.

**Note:**

These formulas give the net power requirement at the cutting tip but power losses in the machine itself have not been included in the calculation. Feed force, torque and power at idling speed must be included.

The power requirement is calculated on the basis of a new tool. For a tool with normal wear, the power requirement is 10–30% higher, depending upon the size of the drill.

**Feed force ( $F_f$  kN)**

$$F_f + F_{f\mu} = 0,65 \times a_p \times f_n \times k_{ctz} \times \sin\kappa_r$$

**Torque ( $M_c$  kNm)**

$$M_c + M_\mu = \frac{D_c \times f_n \times a_p \times k_{ctz}}{2000 \times 10^3} \left( 1,17 - \frac{a_p}{D_c} \right)$$

**Power requirement ( $P_c$  kW)**

$$P_c + P_\mu = \frac{f_n \times v_c \times D_c \times k_{ctz}}{240 \times 10^3} \times 1,34$$

### Specific cutting force

These values are based on a mean chip thickness  $h_m = 0,4$ -mm and a rake angle  $\nu = +6^\circ$ . The following corrections are deviations from these values:

- The specific cutting force  $k_c$  must be corrected for the rake angle.  $k_c$  should be changed about 1% for every degree of change of the rake angle. The greater the rake angle, the smaller the specific cutting force  $k_c$ .

### Cutting Data Modul

When using the Cutting Data Module programme  $F_f$ ,  $M_c$  and  $P_c$  are calculated, see page 140.

Ejē

**Cutting data for CoroDrill® solid drill heads 800.24 and 800.2**

ISO	CMC No.	Material	Specific cutting force	Hardness	Geometry		
			$k_c$ 0,4	Brinell	Insert <sup>1)</sup>		
			N/mm <sup>2</sup>	HB	P	I	
P	01.1	Unalloyed	Non-hardened 0,1-0,25% C	2000	90-200	G/1025	G
	01.2		Non-hardened 0,25-0,55% C	2100	125-225	G/1025	G
	01.3		Non-hardened 0,55-0,80% C	2180	150-250	G/1025	G
	01.4		High carbon steel, annealed	2320	180-275	G/1025	G
	02.1	Low alloy	Non-hardened	2100	150-260	G/1025	G
	02.2		Hardened and tempered	2775	220-450	G/1025	G
	03.11	High alloy	Annealed	2500	150-250	G/1025	G
	03.13		Annealed HSS	2750	150-250	G/1025	G
	03.21		Hardened tool steels	3750	250-350	G/1025	G
	03.22		Hardened steels, others	4000	250-450	G/1025	G
	06.1	Castings	Unalloyed	1800	90-225	G/1025	G
	06.2		Low alloyed (alloying elements <5%)	2100	150-250	G/1025	G
	06.32	Castings	Stainless austenitic	2300	150-250	G/1025	G
	06.33		Manganese steel 12-14% Mn	3600	200-300	G/1025	G
M	05.11	Rolled/forged	Ferritic, martensitic	2300	150-270	G/1025	G

Specific cutting forces, see cutting data tables on pages 86–98.

<b>Problem:</b>	<b>Cause:</b>	<b>Remedy:</b>
<b>Poor surface finish in drilled hole</b>	<ol style="list-style-type: none"> <li>1. Cutting speed too low, support pads experiencing build up and scoring the hole surface.</li> <li>2. Wrong cutting oil, temperature too high, over 55° C. Sulphur or lubricant is being dissipated by heat.</li> <li>3. Poor filtration, small material particles being reproduced over the support pads.</li> <li>4. Worn support pads.</li> <li>5. Vibration, unstable machine or component fixturing.</li> </ol>	<p>Increase speed (rev/min).</p> <p>Have oil sample checked by manufacturer.</p> <p>Increase to proper filtration (40 microns).</p> <p>Replace drill and check cutting speed (rev/min). Check for proper drill grade.</p> <p>Strengthen machine and / or set up.</p>
<b>Chip jamming in the drill head or the inner tube</b>	<ol style="list-style-type: none"> <li>1. Inadequate cutting fluid volume.</li> </ol>	<p>Repair or replace pump. Check the viscosity of the cutting fluid. Check whether filter is clogged.</p> <p>Check whether the pump is rotating in the right direction. Check the plumb between the pump and the connector.</p> <p>Check that the drain line slopes towards the tank.</p>
<b>Correct volume and pressure but cutting fluid is not reaching drill head adequately</b>	<ol style="list-style-type: none"> <li>1. Inner tube too short in relation to outer tube.</li> <li>2. Worn support surface in sealing sleeve for inner tube or missing "O" ring in inner diameter of sealing sleeve.</li> <li>3. The venturi slots in the rear part of the inner tube is worn so that excessive amount of cutting fluid escapes through the exhaust.</li> <li>4. Clogged exhaust line, blocked inner tube.</li> </ol>	<p>Replace with correct length tube.</p> <p>Replace sealing sleeve or inner "O" ring.</p> <p>Replace inner tube.</p> <p>Clear all blockages.</p>
<b>Cutting fluid leaks out between drill bushing and outer tube excessively</b>	<ol style="list-style-type: none"> <li>1. Chip jamming in drill head or flare in inner tube.</li> <li>2. Exhaust line does not slope towards chip disposal area.</li> <li>3. Inner tube is inverted in the wrong direction.</li> </ol>	<p>Clear all system blockages.</p> <p>Adjust exhaust line in a downward position.</p> <p>Correct inner tube direction (flare to drill and venturies towards exhaust).</p>
<b>Drill breakage or insert/inserts chipping prematurely, despite good chip breaking</b>	<ol style="list-style-type: none"> <li>1. Poor Ejector effect</li> <li>2. Chip jamming in drill or inner tube.</li> <li>3. Incorrect start of drilling i.e. centre drilled hole, irregular surface, oversize bushing.</li> </ol>	<p>Check inside diameter of the connections for blockage, whether the drain line slopes evenly, whether the inner tube is constricted or the venturi slots have collapsed or too large.</p> <p>Built-up edge on the central insert can cause crumbling so that long chips are formed and chip flow is blocked. Decrease feed per revolution.</p> <p>Check the clamping of the workpiece so that the workpiece does not move when drilling starts. Change the bushing if it is worn. Check to make sure that the bushing is aligned properly. If there is a centre hole in the workpiece, enlarge it so that peripheral insert starts cutting first, or reduce the bore so that the central inserts starts to cut first.</p>

Continued...

<b>Problem:</b>	<b>Cause:</b>	<b>Remedy:</b>
...continued	<ol style="list-style-type: none"> <li>4. Cross drilling (intersecting holes).</li> <li>5. Overloading of the insert.</li> <li>6. Lack of stability.</li> </ol>	<p>Do not cross drill into and thru, other holes.</p> <p>Decrease the feed per revolution.</p> <p>Strengthen machine or fixture, check all drill connections i.e. connector.</p>
<b>Centre line deviation of hole</b>	<ol style="list-style-type: none"> <li>1. Machine is out of alignment.</li> <li>2. Component is misaligned.</li> <li>3. Oversized bushing.</li> <li>4. Drill tube length excessive.</li> <li>5. Workpiece material (e.g. cast iron often gives poor support).</li> </ol>	<p>Align machine (.0,02 mm head stock to tailstock or fixture).</p> <p>Align component (same tolerance as machine).</p> <p>Change to new bushing (see chart).</p> <p>Apply tube support (every 1,3 m).</p> <p>Adjust cutting data.</p>
<b>Premature tool life and/or insert breakage</b>	<ol style="list-style-type: none"> <li>1. Cutting speed and feed too low.</li> <li>2. Misalignment (machine and component).</li> <li>3. Cutting speed too high.</li> <li>4. Heavy wear on support pad and peripheral insert.</li> <li>5. Unsuitable grade.</li> <li>6. Incorrect coolant volume and pressure. or poor quality coolant.</li> </ol>	<p>Increase cutting data.</p> <p>Align machine or component (0,02 mm).</p> <p>Reduce cutting speed.</p> <p>Change cutting oil. Check filtration of cutting oil. Check drill bushing wear and make sure that the bushing is within required tolerances (see page 136).</p> <p>Switch to suitable grade.</p> <p>Check catalogue graphs for correct volume and pressure.</p>
<b>Oversized hole</b>	<ol style="list-style-type: none"> <li>1. New drill.</li> <li>2. Oversize bushing or misalignment of bushing.</li> <li>3. Unstable machine or set up.</li> </ol>	<p>Hone periphery corner.</p> <p>Change bushing (see chart), realign bushing (rev/min).</p> <p>Increase stability of machine and/or fixture.</p>
<b>Spiraling effect in hole</b>	<ol style="list-style-type: none"> <li>1. Fragmented support pad.</li> <li>2. Misalignment (machining or component).</li> <li>3. Lack of lubricity in coolant.</li> <li>4. Lack of coolant volume.</li> </ol>	<p>Replace drill.</p> <p>Align machine or component (0,02 mm).</p> <p>Increase lubrication additives (E.P. i.e. sulphur).</p> <p>Check for blockages, adjust pressure relief valve. Check inner tube.</p>
<b>Bell mouth at start of hole</b>	<ol style="list-style-type: none"> <li>1. Oversized bushing.</li> <li>2. Lack of rigidity in bush housing.</li> </ol>	<p>Replace bushing (see page 136).</p> <p>Strengthen housing.</p>

ISO	Coromant Material Classification (CMC)	Country									
		Great Britain		Sweden	USA	Germany	France	Italy	Spain	Japan	
		Standard									
		BS	EN	SS	AISI/SAE	W.-nr.	DIN	AFNOR	UNI	UNE	JIS
<b>P</b>	<b>Unalloyed steel</b>										
	01.1	4360 40 C		1311	A570.36	1.0038	RSt.37-2	E 24-2 Ne			STKM 12A;C
	01.1	030A04	1A	1325	1115	1.0038	GS-CK16	-	-	-	-
	01.1	4360 40 B		1312	A573-81 65	1.0116	St.37-3	E 24-U	Fe37-3		
	01.1	080M15	-	1350	1015	1.0401	C15	CC12	C15C16	F.111	-
	01.1	050A20	2C/2D	1450	1020	1.0402	C22	CC20	C20C21	F.112	-
	01.1	230M07	-	1912	1213	1.0715	9SMn28	S250	CF9SMn28	11SMn28	SUM22
	01.1	-	-	1914	12L13	1.0718	9SMnPb28	S250Pb	CF9SMnPb28	11SMnPb28	SUM22L
	01.1	-	-	-	-	1.0722	10SPb20	10PbF2	CF10SPb20	10SPb20	-
	01.1	240M07	1B	-	1215	1.0736	9SMn36	S 300	CF9SMn36	12SMn35	-
	01.1	-	-	1926	12L14	1.0737	9SMnPb36	S300Pb	CF9SMnPb36	12SMnP35	-
	01.1	080M15	32C	1370	1015	1.1141	Ck15	XC12	C16	C15K	S15C
	01.1	-	-	-	1025	1.1158	Ck25	-	-	-	S25C
	01.1	4360 55 E		2145	A572-60	1.8900	StE 380	-	FeE390KG		
	01.1	4360 55 E		2142	A572-60	-	17 MnV 6	NFA 35-501 E 36	-	-	
	01.2	060A35	-	1550	1035	1.0501	C35	CC35	C35	F.113	-
	01.2	080M46	-	1650	1045	1.0503	C45	CC45	C45	F.114	-
	01.2	212M36	8M	1957	1140	1.0726	35S20	35MF4	-	F210G	-
	01.2	150M36	15	-	1039	1.1157	40Mn4	35M5	-	-	-
	01.2	-	-	2120	1335	1.1167	36Mn5	40M5	-	36Mn5	SMn438(H)
	01.2	150M28	14A	-	1330	1.1170	28Mn6	20M5	C28Mn	-	SCMn1
	01.2	060A35	-	1572	1035	1.1183	Cf35	XC38TS	C36	-	S35C
	01.2	080M46	-	1672	1045	1.1191	Ck45	XC42	C45	C45K	S45C
	01.2	060A52	-	1674	1050	1.1213	Cf53	XC48TS	C53	-	S50C
	01.3	070M55	-	1655	1055	1.0535	C55	-	C55	-	-
	01.3	080A62	43D	-	1060	1.0601	C60	CC55	C60	-	-
	01.3	070M55	-	-	1055	1.1203	Ck55	XC55	C50	C55K	S55C
	01.3	080A62	43D	1678	1060	1.1221	Ck60	XC60	C60	-	S58C
	01.4	060 A 96		1870	1095	1.1274	Ck 101	XC 100	-	F-5117	
	01.4	BW 1A		1880	W 1	1.1545	C 105 W1	Y105	C36KU	F-5118	SK 3
	01.4	BW2	-	2900	W210	1.1545	C105W1	Y120	C120KU	F.515	SUP4
		<b>Low-alloy steel (02.1 = Non-hardened, 02.2 = Hardened and tempered)</b>									
	02.1	4360 43C		1412	A573-81	1.0144	St.44-2	E 28-3	-	-	SM 400A;B;C
	02.1	4360 50B		2132	-	1.0570	St.52-3	E36-3	Fe52BFN/Fe52CFN	-	SM490A;B;C;YA;YB
	02.1	150 M 19		2172	5120	1.0841	St.52-3	20 MC 5	Fe52	F-431	
	02.1	250A53	45	2085	9255	1.0904	55Si7	55S7	55Si8	56Si7	-
	02.1	-	-	-	9262	1.0961	60SiCr7	60SC7	60SiCr8	60SiCr8	-
	02.1	534A99	31	2258	52100	1.3505	100Cr6	100C6	100Cr6	F.131	SUJ2
	02.1	1501-240	-	2912	ASTM A204Gr.A	1.5415	15Mo3	15D3	16Mo3KW	16Mo3	-
	02.1	1503-245-420	-	-	4520	1.5423	16Mo5	-	16Mo5	16Mo5	-
	02.1	-	-	-	ASTM A350LF5	1.5622	14Ni6	16N6	14Ni6	15Ni6	-
	02.1	805M20	362	2506	8620	1.6523	21NiCrMo2	20NCD2	20NiCrMo2	20NiCrMo2	SNCM220(H)
	02.1	311-Type 7	-	-	8740	1.6546	40NiCrMo22	-	40NiCrMo2(KB)	40NiCrMo2	SNCM240
	02.1	820A16	-	-	-	1.6587	17CrNiMo6	18NCD6	-	14NiCrMo13	-
	02.1	523M15	-	-	5015	1.7015	15Cr3	12C3	-	-	SCr415(H)
	02.1	-	-	2245	5140	1.7045	42Cr4	-	-	42Cr4	SCR440
	02.1	527A60	48	-	5155	1.7176	55Cr3	55C3	-	-	SUP9(A)
	02.1	-	-	2216	-	1.7262	15CrMo5	12CD4	-	-	SNCM415(H)
	02.1	1501-620Gr27	-	-	ASTM A182 F11;F12	1.7335	13CrMo4 4	15CD3.5	14CrMo4 5	14CrMo45	-
	02.1	1501-622 Gr.31;45	-	2218	ASTM A182 F.22	1.7380	10CrMo9 10	12CD9, 10	12CrMo9, 10	TU.H	-
02.1	1503-660-440	-	-	-	1.7715	14MoV6 3	-	-	13MoCrV6	-	
02.1	722 M 24	-	2240	-	1.8515	31 CeMo 12	30 CD 12	30CrMo12	F-1712	-	
02.1	897M39	40C	-	-	1.8523	39CrMoV13 9	-	36CrMoV12	-	-	
02.1	524A14	-	2092	L1	1.7039	34MoCrS4 G	-	105WCR 5	-	-	
02.1	605A32	-	2108	8620	1.5419	20MoCrS4	-	-	F520.S	-	
02.1	823M30	33	2512	-	1.7228	55NiCrMoV6G	-	653M31	-	-	
02.1	-	-	2127	-	1.7139	16MnCr5	-	-	-	-	
02.1	830 M 31	-	2534	-	-	31NiCrMo134	-	-	-	F-1270	
02.1	-	-	2550	L6	1.2721	50NiCr13	55NCV6	-	-	F-528	
02.2	640A35	111A	-	3135	1.5710	36NiCr6	35NC6	-	-	SNC236	
02.2	-	-	-	3415	1.5732	14NiCr10	14NC11	16NiCr11	15NiCr11	SNC415(H)	
02.2	655M13; A12	36A	-	3415;3310	1.5752	14NiCr14	12NC15	-	-	SNC815(H)	
02.2	-	-	2090	9255	1.0904	55Si7	55S7	-	-	-	

ISO	Coromant Material Classification (CMC)	Country									
		Great Britain		Sweden	USA	Germany		France	Italy	Spain	Japan
		Standard									
	BS	EN	SS	AISI/SAE	W.-nr.	DIN	AFNOR	UNI	UNE	JIS	
<b>P</b>	02.1/02.2	816M40	110	-	9840	1.6511	36CrNiMo4	40NCD3	38NiCrMo4(KB)	35NiCrMo4	-
	02.1/02.2	817M40	24	2541	4340	1.6582	35CrNiMo6	35NCD6	35NiCrMo6(KB)	-	-
	02.1/02.2	530A32	18B	-	5132	1.7033	34Cr4	32C4	34Cr4(KB)	35Cr4	SCr430(H)
	02.1/02.2	530A40	18	-	5140	1.7035	41Cr4	42C4	41Cr4	42Cr4	SCr440(H)
	02.1/02.2	(527M20)	-	2511	5115	1.7131	16MnCr5	16MC5	16MnCr5	16MnCr5	-
	02.1/02.2	1717CDS110	-	2225	4130	1.7218	25CrMo4	25CD4	25CrMo4(KB)	55Cr3	SCM420;SCM430
	02.1/02.2	708A37	19B	2234	4137;4135	1.7220	34CrMo4	35CD4	35CrMo4	AM26CrMo4 34CrMo4	SCM432;SCCRM3
	02.1/02.2	708M40	19A	2244	4140;4142	1.7223	41CrMo4	42CD4TS	41CrMo4	42CrMo4	SCM 440
	02.1/02.2	708M40	19A	2244	4140	1.7225	42CrMo4	42CD4	42CrMo4	42CrMo4	SCM440(H)
	02.1/02.2	722M24	40B	2240	-	1.7361	32CrMo12	30CD12	32CrMo12	F.124.A	-
	02.1/02.2	735A50	47	2230	6150	1.8159	50CrV4	50CV4	50CrV4	51CrV4	SUP10
	02.1/02.2	905M39	41B	2940	-	1.8509	41CrAlMo7	40CAD6, 12	41CrAlMo7	41CrAlMo7	-
	02.1/02.2	BL3	-	-	L3	1.2067	100Cr6	Y100C6	-	100Cr6	-
	02.1/02.2	-	-	2140	-	1.2419	105WCr6	105WC13	10WCr6	105WCr5	SKS31
	02.1/02.2	-	-	-	L6	1.2713	55NiCrMoV6	107WCr5KU 55NCDV7	-	SKS2, SKS3 F.520.S	SKT4
	<b>High-alloy steel</b>										
	03.11	1501-509;510	-	-	ASTM A353	1.5662	X8Ni9	-	X10Ni9	XBNi09	-
	03.11	-	-	-	2515	1.5680	12Ni19	Z18N5	-	-	-
	03.11	832M13	36C	-	-	1.6657	14NiCrMo134	-	15NiCrMo13	14NiCrMo131	-
	03.11	BD3	-	-	D3	1.2080	X210Cr12	Z200C12	X210Cr13KU X250Cr12KU	X210Cr12	SKD1
	03.11	-	-	2314	-	1..2083	-	-	-	-	-
	03.11	BH13	-	2242	H13	1.2344	X40CrMoV5 1	Z40CDV5	X35CrMoV05KU X40CrMoV511KU	X40CrMoV5	SKD61
	03.11	BA2	-	2260	A2	1.2363	X100CrMoV5 1	Z100CDV5	X100CrMoV51KU	X100CrMoV5	SKD12
	03.11	-	-	2312	-	1.2436	X210CrW12	-	X215CrW12 1KU	X210CrW12	SKD2
	03.11	BS1	-	2710	S1	1.2542	45WCrV7	-	45WCrV8KU	45WCrSi8	-
03.11	BH21	-	-	H21	1.2581	X30WCrV9 3 X30WCrV9 3KU	Z30WCV9	X28W09KU X30WCrV9 3KU	X30WCrV9	SKD5	
03.11	-	-	2310	-	1.2601	X165CrMoV 12	-	X165CrMoW12KU	X160CrMoV12	-	
03.11	401S45	52	-	HW3	1.4718	X45GrSi93	Z45CS9	X45GrSi8	F322	SUH1	
03.11	4959BA2	-	2715	D3	1.3343	S6-5-2	Z40CSD10	15NiCrMo13	-	SUH3	
03.13	BM 2	-	2722	M 2	1.3343	S6/5/2	Z 85 WDCV	HS 6-5-2-2	F-5603.	SKH 51	
03.13	BM 35	-	2723	M 35	1.3243	S6/5/2/5	6-5-2-5	HS 6-5-2-5	F-5613	SKH 55	
03.13	-	-	2782	M 7	1.3348	S2/9/2	-	HS 2-9-2	F-5607	-	
03.21	-	-	2736	HNV3	1.2379	X210Cr12 G	-	-	-	-	
<b>Steel castings</b>											
06.2	-	-	2223	-	-	-	-	-	-	-	
06.33	Z120M12	-	-	-	1.3401	G-X120Mn12	Z120M12	XG120Mn12	X120Mn12	SCMnH/1	
06.33	BW 10	-	2183	-	1.3401	-	2120 M12	GX120 Mn12	F-8251	SEMn H1	
<b>Trade names</b>											
02.1	OVAKO 520M (Ovako Steel)										
02.1	FORMAX (Uddeholm Tooling)										
02.1	IMACRO NIT (Imatra Steel)										
02.2	INEXA 482 (XM) (Inexa Profil)										
	S355J2G3(XM)										
	C45(XM)										
	16MnCrS5(XM)										
	INEXA280(XM)										
	070M20(XM)										
02.2	HARDOX 500 (SSAB - Swedish Steel Corp.)										
02.2	WELDOX 700 (SSAB - Swedish Steel Corp.)										



ISO	Coromant Material Classification (CMC)	Country										
		Great Britain		Sweden	USA	Germany		France	Italy	Spain	Japan	
		Standard										
	BS	EN	SS	AISI/SAE	W-nr.	DIN	AFNOR	UNI	UNE	JIS		
M	<b>Stainless steels</b>											
	<b>Ferritic / martensitic materials (05.11, 12 = Forged, 15.11, 12 = Cast)</b>											
	05.11/15.11	403S17	-	2301	403	1.4000 1.4001	X7Cr13 X7Cr14	Z6C13 -	X6Cr13 -	F.3110 F.8401	SUS403 -	
	05.11/15.11	416 S 21	-	2380	416	1.4005	X12CrS13	Z11CF13	X12 CrS 13	F-3411	SUS 416	
	05.11/15.11	430S15	960	2320	430	1.4016	X8Cr17	Z8C17	X8Cr17	F.3113	SUS430	
	05.11/15.11	410S21	56A	2302	410	1.4006	X10Cr13	Z10C14	X12Cr13	F.3401	SUS410	
	05.11/15.11	430S17	60	2320	430	-	X8Cr17	Z8C17	X8Cr17	F.3113	SUS430	
	05.11/15.11	420S45	56D	2304	-	1.4034	X46Cr13	Z40CM Z38C13M	X40Cr14	F.3405	SUS420J2	
	05.11/15.11	405S17	-	-	405	1.4002	-	Z8CA12	X6CrAl13	-	-	
	05.11/15.11	420S37	-	2303	420	1.4021	-	Z20C13	X20Cr13	-	-	
	05.11/15.11	431S29	57	2321	431	1.4057	X22CrNi17	Z15CNi6.02	X16CrNi16	F.3427	SUS431	
	05.11/15.11	-	-	2383	430F	1.4104	X12CrMoS17	Z10CF17	X10CrS17	F.3117	SUS430F	
	05.11/15.11	434S17	-	2325	434	1.4113	X6CrMo17	Z8CD17.01	X8CrMo17	-	SUS434	
	05.11/15.11	425C11	-	2385	CA6-NM	1.4313	X5CrNi13 4	Z4CND13.4M	(G)X6CrNi304	-	SCS5	
	05.11/15.11	403S17	-	-	405	1.4724	X10CrA113	Z10C13	X10CrA112	F.311	SUS405	
	05.11/15.11	430S15	60	-	430	1.4742	X10CrA118	Z10CAS18	X8Cr17	F.3113	SUS430	
	05.11/15.11	443S65	59	-	HNV6	1.4747	X80CrNiSi20	Z80CSN20.02	X80CrSiNi20	F.320B	SUH4	
	05.11/15.11	-	-	2322	446	1.4762	X10CrA124	Z10CAS24	X16Cr26	-	SUH446	
	05.11/15.11	349S54	-	-	EV8	1.4871	X53CrMnNiN21 9	Z52CMN21.09	X53CrMnNiN21 9	-	SUH35, SUH36	
	05.11/15.11	-	-	2326	S44400	1.4521	X1CrMoTi18 2	-	-	-	-	
	05.11/15.11	-	-	2317	-	1.4922	X20CrMoV12-1	-	X20CrMoNi 12 01	-	-	
	05.12/15.12	-	-	-	630	1.4542/ 1.4548	-	Z7CNU17-04	-	-	-	
		<b>Austenitic materials (05.21, 22, 23 = Forged, 15.21, 22, 23 = Cast)</b>										
	05.21/15.21	304S11	-	2352	304L	1.4306	-	Z2CN18-10	X2CrNi18 11	-	-	
	05.21/15.21	304S31	58E	2332/2333	304	1.4350	X5CrNi189	Z6CN18.09	X5CrNi18 10	F.3551 F.3541 F.3504	SUS304	
	05.21/15.21	303S21	58M	2346	303	1.4305	X12CrNiS18 8	Z10CNF 18.09	X10CrNiS 18.09	F.3508	SUS303	
	05.21/15.21	304S15	58E	2332	304	1.4301	X5CrNi189	Z6CN18.09	X5CrNi18 10	F.3551	SUS304	
		304C12	-	2333	-	-	-	Z3CN19.10	-	-	SUS304L	
	05.21/15.21	304S12	-	2352	304L	1.4306	X2CrNi18 9	Z2CrNi18 10	X2CrNi18 11	F.3503	SCS19	
	05.21/15.21	-	-	2331	301	1.4310	X12CrNi17 7	Z12CN17.07	X12CrNi17 07	F.3517	SUS301	
	05.21/15.21	304S62	-	2371	304LN	1.4311	X2CrNiN18 10	Z2CN18.10	-	-	SUS304LN	
	05.21/15.21	316S16	58J	2347	316	1.4401	X5CrNiMo18 10	Z6CND17.11	X5CrNiMo17 12	F.3543	SUS316	
	05.21/15.21	-	-	2375	316LN	1.4429	X2CrNiMoN18 13	Z2CND17.13	-	-	SUS316LN	
	05.21/15.21	316S13	-	2348	316L	1.4404	-	Z2CND17-12	X2CrNiMo1712	-	-	
	05.21/15.21	316S13	-	2353	316L	1.4435	X2CrNiMo18 12	Z2CND17.12	X2CrNiMo17 12	-	SCS16 SUS316L	
	05.21/15.21	316S33	-	2343 2347	316	1.4436	-	Z6CND18-12-03	X8CrNiMo1713	-	-	
	05.21/15.21	317S12	-	2367	317L	1.4438	X2CrNiMo18 16	Z2CND19.15	X2CrNiMo18 16	-	SUS317L	
	05.21/15.21	-	-	2562	UNS V 0890A	1.4539	X1NiCrMo	Z2 NCDU25-20	-	-	-	
	05.21/15.21	321S12	58B	2337	321	1.4541	X10CrNiTi18 9	Z6CNT18.10	X6CrNiTi18 11	F.3553 F.3523	SUS321	
	05.21/15.21	347S17	58F	2338	347	1.4550	X10CrNiNb18 9	Z6CNNb18.10	X6CrNiNb18 11	F.3552 F.3524	SUS347	
05.21/15.21	320S17	58J	2350	316Ti	1.4571	X10CrNiMoTi18 10	Z6NDT17.12	X6CrNiMoTi17 12	F.3535	-		
05.21/15.21	-	-	-	318	1.4583	X10CrNiMoNb 18 12	Z6CNDNb17 13B	X6CrNiMoNb17 13	-	-		
05.21/15.21	309S24	-	-	309	1.4828	X15CrNiSi20 12	Z15CNS20.12	-	-	SUH309		
05.21/15.21	310S24	-	2361	310S	1.4845	X12CrNi25 21	Z12CN25 20	X6CrNi25 20	F.331	SUH310		
05.21/15.21	301S21	58C	2370	308	1.4406	X10CrNi18.08	Z1NCDU25.20	-	F.8414	SCS17		
15.21	-	-	2387	-	1.4418	X4 CrNiMo16 5	Z6CND16-04-01	-	-	-		
05.22/15.22	316S111	-	-	17-7PH	1.4568/ 1.4504	-	Z8CNA17-07	X2CrNiMo1712	-	-		
05.23/15.23	-	-	2584	NO8028	1.4563	-	Z1NCDU31-27-03	-	-	-		
05.23/15.23	-	-	2378	S31254	-	-	Z1CNDU20-18-06AZ	-	-	-		
	<b>Austenitic / ferritic materials (Duplex) (05.51, 52 = Forged, 15.51, 52 = Cast)</b>											
05.51/15.51	-	-	2376	S31500	1.4417	X2CrNiMoSi19 5	-	-	-	-		
05.51/15.51	-	-	2324	S32900	-	X8CrNiMo27 5	-	-	-	-		
05.52/15.52	-	-	2327	S32304	-	X2CrNiN23 4	Z2CN23-04AZ	-	-	-		
05.52/15.52	-	-	2328	-	-	-	-	-	-	-		
05.52/15.52	-	-	2377	S31803	-	X2CrNiMoN22 53	Z2CND22-05-03	-	-	-		



ISO	Coromant Material Classification (CMC)	Country									
		Great Britain		Sweden	USA	Germany		France	Italy	Spain	Japan
		Standard									
		BS	EN	SS	AISI/SAE	W.-nr.	DIN	AFNOR	UNI	UNE	JIS
<b>M</b>		<b>Trade names</b>									
		<b>Stainless steels</b>									
	05.21/15.21	SANMAC 304 (Sandvik Steel)									
	05.21/15.21	SANMAC 304L (Sandvik Steel)									
	05.21/15.21	SANMAC 316 (Sandvik Steel)									
	05.21/15.21	SANMAC 316L (Sandvik Steel)									
	05.23/15.23	254 SMO									
	05.23/15.23	654 SMO									
	05.23/15.23	SANMAC SANICRO (Sandvik Steel)									
	05.52/15.52	SANMAC SAF 2205 (Sandvik Steel)									
05.52/15.52	SANMAC SAF 2507 (Sandvik Steel)										
<b>K</b>	<b>Malleable cast iron</b>										
	07.1	8 290/6		0814			-	MN 32-8			FCMB310
	07.1	B 340/12		0815	32510		GTS-35	MN 35-10			FCMW330
	07.2	P 440/7		0852	40010	0.8145	GTS-45	Mn 450	GMN 45		FCMW370
	07.2	P 510/4		0854	50005	0.8155	GTS-55	MP 50-5	GMN 55		FCMP490
		P 570/3		0858	70003		GTS-65	MP 60-3			FCMP540
	07.2	P570/3		0856	A220-70003	0.8165	GTS-65-02	Mn 650-3	GMN 65	-	FCMP590
	07.3	P690/2		0862	A220-80002	0.8170	GTS-70-02	Mn700-2	GMN 70		FCMP690
	<b>Grey cast iron</b>										
	08.1			0100							
	08.1			0110	No 20 B		GG 10	Ft 10 D			FC100
	08.1	Grade 150		0115	No 25 B	0.6015	GG 15	Ft 15 D	G 15	FG 15	FC150
	08.1	Grade 220		0120	No 30 B	0.6020	GG 20	Ft 20 D	G 20		FC200
	08.2	Grade 260		0125	No 35 B	0.6025	GG 25	Ft 25 D	G 25	FG 25	FC250
					No 40 B						
	08.2	Grade 300		0130	No 45 B	0.6030	GG 30	Ft 30 D	G 30	FG 30	FC300
	08.2	Grade 350		0135	No 50 B	0.6035	GG 35	Ft 35 D	G 35	FG 35	FC350
	08.2	Grade 400		0140	No 55 B	0.6040	GG 40	Ft 40 D			
	08.3	L-NiCuCr202		0523	A436 Type 2	0.6660	GGL-NiCr202	L-NC 202	-	-	
	<b>Nodular cast iron</b>										
	09.1	SNG 420/12		0717-02	60-40-18	0.7040	GGG 40	FCS 400-12	GS 370-17	FGE 38-17	FCD400
	09.1	SNG 370/17		0717-12	-		GGG 40.3	FGS 370-17			
	09.1	-		0717-15	-	0.7033	GGG 35.3	-			
	09.1	SNG 500/7		0727-02	80-55-06	0.7050	GGG 50	FGS 500-7	GS 500	FGE 50-7	FCD500
	09.1	Grade S6		0776	A43D2	0.7660	GGG-NiCr202	S-NC 202	-	-	
09.2	SNG 600/3		0732-03	-		GGG 60	FGS 600-3			FCD600	
09.2	SNG 700/2		0737-01	100-70-03	0.7070	GGG 70	FGS 700-2	GS 700-2	FGS 70-2	FCD700	

ISO	Coromant Material Classification (CMC)	Country										
		Great Britain		Sweden	USA	Germany		France	Italy	Spain	Japan	
		Standard										
	BS	EN	SS	AISI/SAE	W.-nr.	DIN	AFNOR	UNI	UNE	JIS		
<b>N</b> Non-ferrous metals	30.21	-	-	4251	SC64D	3.2373	G-AISI9MGWA	A-S7G	-	-	C4BS	
	30.21	LM5	-	4252	GD-AISI12	-	G-ALMG5	A-SU12	-	-	AC4A	
	30.21/30.22	LM25		4244	356.1							A5052
				4247	A413.0							GD-AISI12
		LM24		4250	A380.1			GD-AISI8Cu3				A7075
		LM20		4260	A413.1			G-AISI12(Cu)				ADC12
		LM6		4261	A413.2			G-AISI12				
	LM9		4253	A360.2			G-AISI10Mg(Cu)					
<b>S</b> Heat resistant super alloys	<b>Heat resistant super alloys</b>											
	20.11	-	-	-	330	1.4864	X12NiCrSi36 16	Z12NCS35.16	F-3313	-	SUH330	
	20.11	330C11	-	-	-	1.4865	G-X40NiCrSi38 18	-	XG50NiCr39 19	-	SCH15	
	20.21	-	-	-	5390A	2.4603	-	NC22FeD	-	-		
	20.21	-	-	-	5666	2.4856	NiCr22Mo9Nb	NC22FeDNB	-	-		
	20.21	HR5,203-4	-	-	-	2.4630	NiCr20Ti	NC20T	-	-		
	20.22	-	-	-	5660	LW2.4662	NiFe35Cr14MoTi	ZSNCDT42	-	-		
	20.22	3146-3	-	-	5391	LW2 4670	S-NiCr13A16MoNb	NC12AD	-	-		
	20.22	HR8	-	-	5383	LW2.4668	NiCr19Fe19NbMo	NC19eNB	-	-		
	20.22	3072-76	-	-	4676	2.4375	NiCu30Al	-	-	-		
	20.22	Hr401,601	-	-	-	2.4631	NiCr20TiAk	NC20TA	-	-		
	20.22	-	-	-	AMS 5399	2.4973	NiCr19Co11MoTi	NC19KDT	-	-		
	20.22	-	-	-	AMS 5544	LW2.4668	NiCr19Fe19NbMo	NC20K14	-	-		
	20.24	-	-	-	AMS 5397	LW2 4674	NiCo15Cr10MoAlTi	-	-	-		
	20.32	-	-	-	5537C	LW2.4964	CoCr20W15Ni	KC20WN	-	-		
		-	-	-	AMS 5772	-	CoCr22W14Ni	KC22WN	-	-		
	<b>H</b> Heat resistant super alloys	<b>Titanium alloys</b>										
		23.22	TA14/17	-	-	AMS R54520	-	TiAl5Sn2.5	T-A5E	-	-	
		23.22	TA10-13/TA28	-	-	AMS R56400	-	TiAl6V4	T-A6V	-	-	
		23.22	TA11	-	-	AMS R56401	-	TiAl6V4ELI	-	-	-	
		23.22	-	-	-	-	-	TiAl4Mo4Sn4Si0.5	-	-	-	
<b>H</b> Heat resistant super alloys		<b>Trade names</b>										
		20.11	<b>Iron base</b>									
			Incoloy 800									
			<b>Nickel base</b>									
			Haynes 600									
	Nimocast PD16											
	Nimonic PE 13											
	Rene 95											
	Hastelloy C											
	Incoloy 825											
Inconel 600												
Monet 400												
Inconel 700												
Inconel 718												
Mar - M 432												
Nimonic 901												
Waspaloy												
Jessop G 64												
<b>Cobalt base</b>												
Air Resist 213												
Jetalloy 209												
<b>H</b> Hardened materials	<b>Hardened materials</b>											
	04.1	-	-	2258-08	440A	1.4108	X100CrMo13	-	-	-	C4BS	
	04.1	-	-	2534-05	610	1.4111	X110CrMoV15	-	-	-	AC4A	
	04.1	-	-	2541-06	0-2	-	X65CrMo14	-	-	-	AC4A	

**Easier handling with ergonomic Torx Plus®**

The new Torx Plus grip with the elliptical shape can transfer 25% more torque than the existing Torx. The new shape and a tighter grip means less risk of damage to the screw head and makes handling more stable.

Sandvik Coromant has introduced the Torx Plus system on all insert screws to ensure improved and secure clamping.

The new Torx Plus screws will keep their previous ordering codes, while the keys will change codes (see table below).

All keys for insert clamping affected are: screwdrivers, T-style keys, L-style keys, flag style keys and combination keys (Torx Plus/hex). All of them, except the L-keys and bits, are easily identified by the red and yellow handle.

**Cross section**

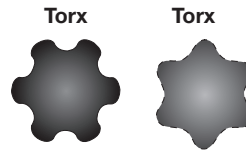

Torx Plus is a registered trademark of Camcar-Textron (USA).

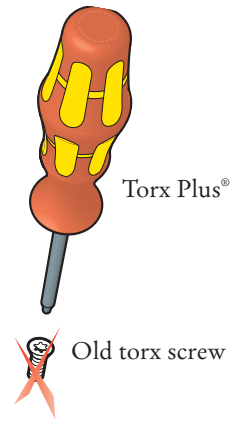





**Note!**

We want to point out to all our customers that the new Torx Plus keys and screwdrivers do NOT fit into the standard Torx screws.

However, the standard Torx keys and screw-drivers will fit the new Torx Plus screws.

**Cross reference list – Torx to Torx Plus**

Type of key	Old Torx keys			New Torx Plus keys		Comments
	Torx size	Code	Torx designation	Code	Torx Plus designation	
T-keys 	15 10 20 20 25 25 30	5680 045-02 5680 045-06 5680 045-03 5680 045-01 5680 045-05 5680 045-04 5680 045-07	T15 T10 T20 T20 T25 T25 T30	5680 048-01 5680 048-02 5680 048-03 5680 048-04 5680 048-05 5680 048-06 5680 048-07	15IP 10IP 20IP 20IP 25IP 25IP 30IP	Length 53 mm Length 90 mm Length 70 mm Length 110 mm
Flag keys 	6 7 9 9 15 15	5680 041-02 5680 041-01 5680 016-03 170.3-865 5680 016-01 5680 016-02	T6 T7 T9 T9 T15 T15	5680 051-01 5680 051-02 5680 049-03 5680 051-03 5680 049-01 5680 049-02	6IP 7IP 9IP 9IP 15IP 15IP	Combination key – 9IP and hex 3,5  Combination key – 15IP and hex 3,5 mm Combination key – 15IP and hex 4,0 mm
Drivers 	7 8 9 10 15 20 25 30	416.1-860 416.1-861 416.1-862 416.1-863 416.1-864 416.1-865 416.1-866 416.1-867	T7 T8 T9 T10 T15 T20 T25 T30	5680 046-03 5680 046-01 5680 046-04 5680 046-05 5680 046-02 5680 046-06 5680 046-07 -	7IP 8IP 9IP 10IP 15IP 20IP 25IP -	
L-keys 	8 9 10 15 20 25 27 30	5680 043-08 5680 043-01 5680 043-05 5680 043-09 5680 043-03 5680 043-04 5680 043-06 5680 043-07	T8 T9 T10 T15 T20 T25 T27 T30	5680 043-10 5680 043-11 5680 043-12 5680 043-13 5680 043-14 5680 043-15 5680 043-16 5680 043-17	8IP 9IP 10IP 15IP 20IP 25IP 27IP 30IP	
Bits 	7 8 9 10 15 - 20 - 25 30	5680 081-01 5680 081-02 5680 081-03 5680 081-04 5680 081-05 - 5680 081-06 - 5680 081-07 5680 081-08	T7 T8 T9 T10 T15 - T20 - T25 T30	5680 084-04 5680 084-01 5680 084-05 5680 084-06 5680 084-02 5680 084-03 5680 084-07 5680 084-08 5680 084-09 5680 084-10	7IP 8IP 9IP 10IP 15IP 15IP 20IP 20IP 25IP 30IP	Length 50 mm Length 50 mm Length 50 mm Length 50 mm Length 50 mm Length 89 mm Length 50 mm Length 89 mm Length 89 mm Length 89 mm
Bits set	7 – 25	5680 082-01	T7 – T25	-	-	

## **Safety information in connection with grinding of cemented carbide**

### **Ingredients**

Hard metal products contain tungsten carbide and cobalt and may also include titanium carbide, tantalum carbide, niobium carbide, chromium carbide, molybdenum carbide or vanadium carbide. Some grades contain titanium carbonitride and/or nickel.

### **Routes of exposure**

Grinding or heating a hard metal blank or a hard metal product will produce dust or fumes with dangerous ingredients that can be inhaled, swallowed or come in contact with the skin or eyes.

### **Acute toxicity**

The dust is toxic by inhalation. Inhalation may cause irritation and inflammation in the airways. A significantly higher acute inhalation toxicity has been reported during simultaneous inhalation of cobalt and tungsten carbide compared to inhalation of cobalt alone.

Skin contact can cause irritation and rash. Persons who have sensitive skin may experience an allergic reaction.

### **Chronic toxicity**

Repeated inhalation of aerosols containing cobalt may cause obstruction in the airways. Prolonged inhalation of increased concentrations may cause lung fibrosis or lung cancer. Epidemiological studies indicate that workers exposed in the past to high concentrations of tungsten carbide/cobalt carried an increased risk of developing lung cancer.

Cobalt and nickel are potent skin sensitizers. Repeated or prolonged contact can cause irritation.

### **Risk phrases**

Toxic: danger of serious damage to health by prolonged exposure through inhalation

Toxic by inhalation

Possible risks of irreversible effects

May cause sensitization by inhalation and skin contact

### **Preventive measures**

- Avoid formation and inhalation of dust. Use local exhaust ventilation that is adequate to limit personal exposure well below the nationally authorised limits.
- If ventilation is not available or adequate, use respirators nationally approved for the purpose.
- Use safety goggles or glasses with side shields when necessary.
- Avoid repeated skin contact. Wear suitable gloves. Wash skin thoroughly after handling.
- Use suitable protective clothing. Launder clothing as needed.
- Do not eat, drink or smoke in the working area. Wash skin thoroughly before eating, drinking or smoking.



A series of horizontal dotted lines spanning the width of the page, providing a template for handwritten notes or applications.

# Index

Tool code	Page	Tool code	Page	Tool code	Page
002	111	420.5-805-...	51, 55, 65	420.6-982...	50
003	111	420.5-806-...	51, 55, 65	420.6-991...	50
004	111	420.5-807-...	51, 55, 65	420.6-992...	50
005	111	420.5-808-...	51, 55, 65	420.9S/173-...	77
006	111	420.5-809-...	51, 55, 65	420.9S/188-...	77
010	111	420.5-810-...	51, 55, 67	420.9S/344-...	77
016	111	420.5-811-...	51, 55, 67	420.9S/348-...	77
020	111	420.5-812-...	51, 55, 67	420.9S-500	72, 74
025	111	420.5-813-...	51, 55, 59, 67	420.9S-501	72, 74
035	111	420.5-813E-...	51, 55, 59	420.9S-502	72, 74
036	111	420.5-814-...	59, 67, 69	420.9S-503	72, 74
101	111	420.5-815-...	59, 67, 69	420.9S-504	72, 74
102	111	420.5-816-...	59, 67, 69	420.9S-505	72, 74
103	111	420.5-817-...	59, 67, 69	420.9S-506	72, 74
104	111	420.5-818-...	59, 67, 69	420.9S-507	72, 74
204	111	420.5-819-...	59, 67, 69	420.9S-508	72, 74
205	111	420.5-820-...	59, 67, 69	420.9S-509	72, 74
206	111	420.5-821-...	59, 67, 69	420.9S-510	72, 74
207	111	420.5-822-...	59, 69	420.9S-511	72, 74
208	111	420.5-823-...	59, 69	420.9S-512	72, 74
209	111	420.5-824-...	59, 69	420.9S-513	72, 74
302	111	420.5-825-...	59, 69	420.9S-514	72, 74
303	111	420.5-826-...	69	420.9S-515	72, 74
304	111	420.5-827-...	69	420.9S-516	72, 74
305	111	420.5-828-...	69	420.9S-517	72, 74
405	111	420.5-829-...	69	420.9S-518	72, 74
406	111	420.5-830-...	69	420.9S-519	72, 74
407	111	420.5-831-...	69	420.9S/520	72, 74
408	111	420.5-832-...	69	420.9S/521	72, 74
409	111	420.5-833-...	69	420.9S/522	72, 74
501	111	420.6-001...	50	420.9S/523	72, 74
503	111	420.6-002...	50	420.9S/524	72, 74
504	111	420.6-011...	50	424.10-0650	22, 58
505	111	420.6-012...	50	424.10-0650E	22, 58
601	111	420.6-021...	50	424.10-0700	22, 58
602	111	420.6-022...	50	424.10-0750	22, 58
603	111	420.6-031...	50	424.10-0800	22, 58
604	111	420.6-032...	50	424.10-0850	22, 58
605	111	420.6-041...	50	424.10-0900	22, 58
606	111	420.6-042...	50	424.10-0950	22, 58
607	111	420.6-051...	50	424.10-1000	22, 58
608	111	420.6-052...	50	424.10-1050	22, 58
701	111	420.6-061...	50	424.10-1100	22, 58
702	111	420.6-062...	50	424.10-1150	22, 58
801	111	420.6-071...	50	424.10-1200	22, 58
802	111	420.6-072...	50	424.10-1250	22, 58
903	111	420.6-081...	50	424.10-1300	22, 58
904	111	420.6-082...	50	424.2-400M	34, 36
905	111	420.6-083...	50	424.2-400M-V63	34, 36
906	111	420.6-091...	50	424.2-401M	34, 36
907	111	420.6-092...	50	424.2-402	35, 36
908	111	420.6-093...	50	424.2-410	34, 37
909	111	420.6-101...	50	424.2-411	34, 37
3022 010-...	104	420.6-102..	50	424.2-412	35, 37
342-0937-1	72, 76	420.6-103	50	424.2-413	35, 37
342-0938-1	72, 76	420.6-111...	50	424.2-420-...	34
342-0939-1	72, 76	420.6-112..	50	424.2-421-...	34
420.37-410-01	30, 66	420.6-113..	50	424.2-422-...	35
420.37-415-01	30, 66	420.6-121...	50	424.2-423-...	35
420.37-510-01	30, 66	420.6-122..	50	424.2.430-...	34
420.5.797-...	51	420.6-123..	50	424.2.431-...	34
420.5.798-...	51	420.6-131...	50	424.2-432-...	35
420.5.799-...	51	420.6-132...	50	424.2-433-...	35
420.5-800-...	51, 65	420.6-133...	50	424.2-800-...	15, 29
420.5-801-...	51, 65	420.6-134...	50	424.2-801-...	15, 29
420.5-802-...	51, 65	420.6-971...	50	424.2-802-...	15, 29
420.5-803-...	51, 55, 65	420.6-972...	50	424.2-803-...	15, 19, 29
420.5-804-...	51, 55, 65	420.6-981...	50	424.2-804-...	15, 19, 29

# Index

Tool code	Page	Tool code	Page	Tool code	Page
424.2-805-...	15, 19, 29	424.6-093...	14	800.24-10D...	18
424.2-806-...	15, 19, 29	424.6-101...	14	800.24-11D...	18
424.2-807-...	15, 19, 29	424.6-102...	14	800.24-12D...	18
424.2-808-...	15, 19, 29	424.6-103...	14	800.24-13D...	18, 54
424.2-809-...	15, 19, 29	424.6-111...	14	800-...-C-G	18, 54, 81, 110
424.2-810-...	15, 19, 31	424.6-112...	14	800-...-I-G	18, 54, 81, 110
424.2-811-...	15, 19, 31	424.6-113...	14	800-...-I-L	81
424.2-812-...	15, 19, 31	424.6-121...	14	800-...-P-G	18, 54, 81, 110
424.2-813-...	15, 19, 33, 31	424.6-122...	14	800-...-P-L	81
424.2-814-...	23, 33, 31	424.6-123...	14	805	109
424.2-815-...	23, 33, 31	424.6-131...	14	840110R31...	41
424.2-816-...	23, 33	424.6-132...	14	840110R32...	41
424.2-817-...	23, 33	424.6-133...	14, 50	A424.10-2500	22, 58
424.2-818-...	23, 33	424.6-134...	14, 50	A424.10-2750	22, 58
424.2-819-...	23, 23	424.814-...	31	A424.10-2813	22, 58
424.2-820-...	23, 33	424.815-...	31	A424.10-3000	22, 58
424.2-821-...	23, 23	424.816-...	31	A424.10-3250	22, 58
424.2-822-...	23, 33	424.817-...	31	A424.10-3500	22, 58
424.2-823-...	23, 33	424.818-...	31	A424.10-3750	22, 58
424.2-824-...	23, 33	424.819-...	31	A424.10-4000	22, 58
424.2-825-...	23, 33	424.820-...	31	A424.10-4250	22, 58
424.2-850-...	15, 29	424.821-...	31	A424.10-4500	22, 58
424.2-851-...	15, 29	424.9S/170-1	34, 36	A424.10-4750	22, 58
424.2-852-...	15, 29	424.9S/224-1	36	A424.10-5000	22, 58
424.2-853-...	15, 19, 29	424.9S/231-1	34, 36	L430.27-1216-16	70
424.2-854-...	15, 19, 29	424.9S/232-1...	35, 38	L430.31-1216-16	22, 58
424.2-855-...	15, 19, 29	424.9S/233-...	38	L430.31-1522-22	22, 58
424.2-856-...	15, 19, 29	424.9S/245-1	36	R424.31F	85
424.2-857-...	15, 19, 29	424.9S/279...	41	R424.9-...-22	58, 70, 83
424.2-858-...	15, 19, 29	424.9S/280...	41	R424.9-...-23	58, 70, 83
424.2-859-...	15, 19, 29	424.9S/281...	41	R430.23-2024-16	32, 68
424.2-860-...	15, 19, 31	424.9S/282...	41	R430.23-2532-22	32, 68
424.2-861-...	15, 19, 31	424.9S/283...	41	R430.24-1018-09	66
424.2-862-...	15, 19, 31	428.2	110	R430.24-1118-06	30, 66
424.2-863-...	15, 19, 23, 31	428.9	110	R430.24-1118-09	30
424.2-864-...	23, 31, 33, 38	430.21-06D...	28, 64	R430.24-2024-12	32, 68
424.2-865-...	23, 31, 33, 38	430.21-08D...	28, 64	R430.24-2532-19	32, 68
424.2-866-...	23, 31, 33, 38	430.21-10D...	30, 66	R430.28-1516-16	22, 58, 70
424.2-867-...	23, 31, 33, 38	430.21-12D...	30, 32, 66, 68	R430.28-1822-22	22, 58
424.2-868-...	23, 31, 33, 38	430.21-16D...	30, 32, 66, 68	R430.30-1216-16	22, 58
424.2-869-...	23, 31, 33, 38	430.21-18D...	32, 68, 70	R430.30-1522-22	58, 22
424.2-870-...	23, 31, 33, 38	430.32-12D...	22, 58, 83	S-424.2-422-...	35
424.2-871-...	23, 31, 33, 38	430.32-16D...	22, 58, 83	SNMG	85
424.2-872-...	23, 33, 38	5636 010-...	28, 64	SNMG...-15	85
424.2-873-...	23, 33, 38	5636-020-011	66	SNMM	85
424.2-874-...	23, 33, 38	800-06A	18, 54, 81, 110	TBSG 2,5-32	143
424.2-875-...	23, 33, 38	800-08A	18, 54, 81, 110	TBSM 2-32	143
424.6-001...	14	800-09A	18, 54, 81, 110	TPMT-... -22	58, 83
424.6-002...	14	800-10A	18, 54, 81, 110	TPMT-... -23	58, 83
424.6-011...	14	800-12A	18, 54, 81, 110	TPMX	85, 105
424.6-012...	14	800.20-03D...	54	TPUN	85, 105
424.6-021...	14	800.20-04D...	54	ZLBSG	143
424.6-022...	14	800.20-05D...	54		
424.6-031...	14	800.20-06D...	54		
424.6-032...	14	800.20-07D...	54		
424.6-041...	14	800.20-08D...	54		
424.6-042...	14	800.20-09D...	54		
424.6-051...	14	800.20-10D...	54		
424.6-052...	14	800.20-11D...	54		
424.6-061...	14	800.20-12D...	54		
424.6-062...	14	800.20-13D...	54		
424.6-071...	14	800.24-03D...	18		
424.6-071...	14	800.24-04D...	18		
424.6-072...	14	800.24-05D...	18		
424.6-082...	14	800.24-06D...	18		
424.6-083...	14	800.24-07D...	18		
424.6-091...	14	800.24-08D...	18		
424.6-092...	14	800.24-09D...	18		





# For the sake of the environment

## Get into the Coromant Recycling Concept (CRC) now!

The Coromant Recycling Concept (CRC) is a comprehensive service for used carbide inserts offered by Sandvik Coromant to all its customers.

In the light of increasing consumption of non-renewable raw materials, the economic management of dwindling resources is a duty owed by all manufacturers.

Sandvik Coromant is playing its part by offering to collect used carbide inserts and recycle them in the most environmentally friendly way.

Order a collection box for each lathe, milling machine, drill or for your machining centre. We recommend one collection box for each cutting workplace.

All used hard-metal inserts are stored in the collection box at the workplace.

When the collection box is sufficiently full, its contents are transferred to the transport box. We recommend using two transport boxes e.g. in the storeroom for each factory.

The full transport box is then sent to the nearest Sandvik Coromant office or to your Coromant dealer who can also give you more information.

The benefits of the CRC speak for themselves

- A one-stop worldwide recycling system.
- Available to direct and trade customers.
- Simple procedure with collection and transport boxes.
- Less waste, easing the burden on the environment.
- Better utilisation of resources.
- Other manufacturers' carbide inserts are also accepted.

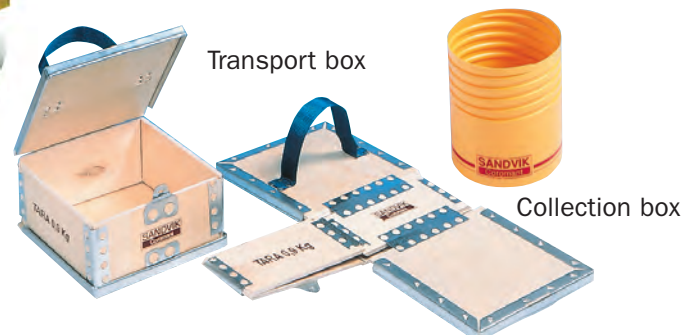

Order number for collection box: 91617  
Order number for transport box: 92995

Head office:  
AB Sandvik Coromant  
SE-811 81 Sandviken, Sweden  
[www.sandvik.coromant.com](http://www.sandvik.coromant.com)  
E-mail: [info.coromant@sandvik.com](mailto:info.coromant@sandvik.com)

